

# Measurements of and correlations between block size and rock quality designation (RQD)

Arild Palmstrom \*

Norconsult AS, Vestfjordgaten 4, N-1338 Sandvika, Norway

Received 4 November 2004; received in revised form 17 January 2005; accepted 18 January 2005

Available online 3 March 2005

## Abstract

Various measurements of the block size or degree of jointing (i.e. density of joints, RQD, block volume, joint spacing) are described. It is concluded that the RQD measurements are encumbered with several limitations and that this parameter should be applied with care. These limitations influence the engineering results where RQD is applied in classification systems, numerical modelling and other engineering assessments.

The three-dimensional block volume ( $V_b$ ) and the volumetric joint count ( $J_v$ ) measurements give much better characterizations of the block size. As the block size forms an important input to most rock engineering calculations and estimates, it is important to select the most appropriate method to measure this parameter.

Correlations between various measurements of block size have been presented. It turned out difficult to find any reliable correlation between RQD and other block size measurements. An adjusted, better equation between RQD and  $J_v$  than the existing is presented, though still with several limitations.

More efforts should be made to improve the understanding on how to best measure the block size in the various types of exposures and patterns of jointing.

© 2005 Elsevier Ltd. All rights reserved.

**Keywords:** Block size measurement; RQD; Rock mass jointing; Jointing correlations; Volumetric joint count

## 1. Introduction

The following three quotations illustrate the background for this paper:

*“Since joints are among the most important causes of excessive overbreak and of trouble with water, they always deserve careful consideration.”* Karl Terzaghi, 1946.

*“Provision of reliable input data for engineering design of structures in rock is one of the most difficult tasks facing engineering geologists and design engineers. It is extre-*

*mely important that the quality of the input data matches the sophistication of the design methods.”* Z.T. Bieniawski, 1984.

*“I see almost no research effort being devoted to the generation of the basic input data which we need for our faster and better models and our improved design techniques.”* Evert Hoek, 1994.

Thus, this paper aims at giving practical information on jointing and input of block size, including:

- different methods to characterize the block size or the degree of jointing;
- difficulties and errors related to some common methods to measure rock mass jointing; and
- correlations between various block size measurements.

\* Present address: Ovre Smestad vei 25e, N-0378 Oslo, Norway. Tel.: +47 6754 4576; fax: +47 6757 1286.

E-mail address: [ap@norconsult.no](mailto:ap@norconsult.no).

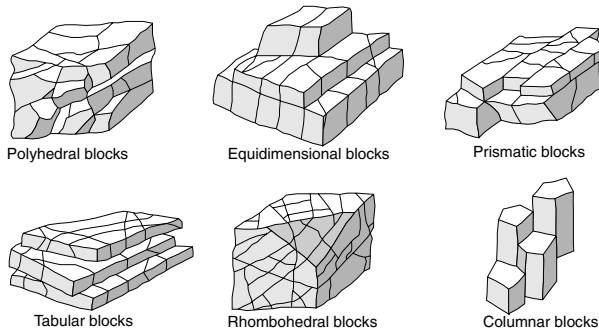

Fig. 1. Examples of some shapes of defined blocks (modified from Dearman, 1991).

*Block size* is in this paper used as a common expression for the *degree of jointing*, *density of joints*, *block volume*, and *joint spacing*. Further, the term *joint* includes joints, fissures, fractures, cracks, and breaks penetrating rock masses. Parallel oriented joints form a *joint set*. *Random joints* are joints, which do not belong to any joint set, or are in this paper considered as having spacing of 5 m or more.

Fig. 1 shows some typical blocks formed by joints. A great variety in sizes and shapes of rock blocks complicates the measurement of this parameter. Also the block shape is often important in the behaviour of rock masses. This is presented in Section 6.1

## 2. The importance of block size in rock engineering

The joints intersecting a rock mass divide the rock into blocks with sizes ranging from cube sugar of  $\text{cm}^3$  in fragmented or crushed rock to several  $\text{m}^3$  in massive rock. The sizes are a result of the joint spacings, the number of joint sets, and the size and persistence of the joints. The block size is an extremely important parameter in rock mass behaviour (Barton, 1990; ISRM, 1978). Also Goodman (1993) states that “*Joints are extremely important in some rock masses. Even though the rock substance itself may be strong or impermeable, or both, the system of joints create significant weakness and fluid conductivity.*” Many scale effects in rock engineering can be explained by this feature, including compression strength, deformation modulus, shear strength, dilation, and conductivity.

The sizes of the blocks surrounding an underground excavation may also determine whether the rock masses will behave as a continuous (bulk) material, or as a discontinuous material influenced by the properties and geometries of the joints.

### 2.1. Block size used in classification systems

Being an important parameter the block size is represented, either explicitly or implicitly, in the main quanti-

tative rock mass engineering classification systems used in design of rock support, such as

- the ratio between RQD and a factor for the number of joint sets ( $J_n$ ) in the Q system,
- RQD and joint spacing ( $S$ ) in the RMR system, and
- block volume ( $V_b$ ) in the RMi (rock mass index), and the number of joints sets ( $n_j$ ) when RMi is applied in rock support evaluation.

Also the qualitative GSI (geological strength index) system applies block size expressed as various degrees of blocky and broken rock masses in the determination of its values for rock mass strength.

### 2.2. Block size used in numerical modelling and analytical calculations

Most methods for numerical modelling and many analytical calculations apply input of the rock mass strength and/or the rock mass deformation modulus. By this, the block size is used indirectly as shown in the following two sections. Some numerical modelling methods also use block size (joints spacings) as input.

#### 2.2.1. Rock mass strength

A method to find/calculate/assess the rock mass strength was published by Hoek and Brown in 1980:

$$\sigma_{\text{cm}} = \sigma_c \times s^{1/2}, \quad (1)$$

where the value of  $s$  is found from input of RMR values (and thus including block size) in the equation

$$s = e^{\frac{\text{RMR}-100}{9}}. \quad (2)$$

The value of  $s$  can also be found using input of GSI:

$$s = e^{\frac{\text{GSI}-100}{9}}, \quad (3)$$

limited to  $\text{GSI} > 25$  (when  $\text{GSI} < 25$ ,  $s = 0$ ).

A more direct method to assess the strength of rock masses has been presented by Palmstrom (1995):

$$\sigma_{\text{cm}} \approx \text{RMi} = 0.2\sqrt{jC} \times V_b^D, \quad (4)$$

( $jC$  is the joint condition factor, including roughness and size of the joints, while the exponent  $D = 0.37jC^{-0.2}$  varies within 0.2 and 0.6.) In common conditions (for  $jC = 1.75$ )

$$\text{RMi} \approx 0.25\sqrt[3]{V_b}. \quad (5)$$

#### 2.2.2. Rock mass deformation

In addition to various in situ deformation tests (plate jacking test, plate loading test, Goodman jack test), the deformation modulus of rock masses can be estimated from  $Q$ , RMR, and RMi values in the following expressions:

$$E_m = 2RMR - 100 \quad \text{for } RMR > 50$$

(Bieniawski, 1978) (6)

$$E_m = 10^{(RMR-10)/40} \quad \text{for } 30 < RMR \leq 50$$

(Serafim and Pereira, 1983) (7)

$$E_m = 25 \log_{10} Q \quad \text{for } Q > 1$$

(Grimstad and Barton, 1993) (8)

$$E_m = 7RMI^{0.5} \quad \text{for } 1 < RMI \leq 30$$

(Palmström and Singh, 2001) (9)

$$E_m = 7RMI^{0.4} \quad \text{for } RMI > 30. \quad (10)$$

Thus, also for the deformation modulus block size is used indirectly.

### 3. Types of block size measurements

Measurements of the joints and their characteristics in a rock mass are often difficult. Joints form complicated three-dimensional patterns in the crust, while the measurements mostly are made on two-dimensional surfaces and on one-dimensional boreholes or along scan-lines. Hence, only limited parts of the joints can be correctly measured in a location. When the jointing is more or less irregular with variations in size and length, as in Fig. 2, it is not easy to characterize the blocks, which show great variation in size. Fig. 2 is used as examples in some of the following sections.

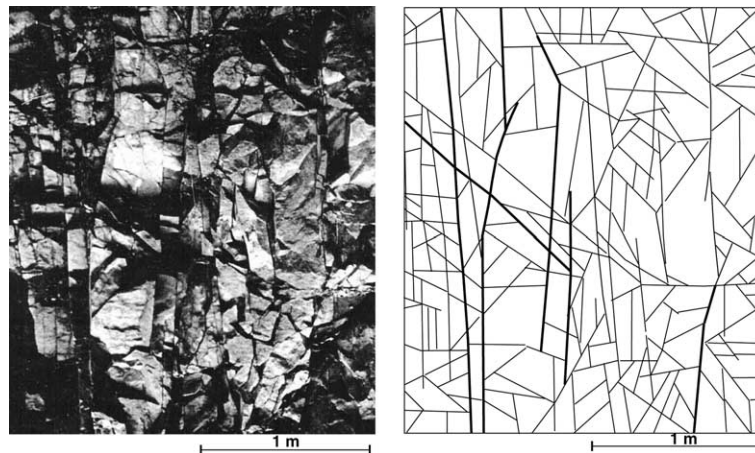

Fig. 2. Photo and interpretation of (irregular) jointing of a dolerite (diabase), which shows the difficulties involved in block size measurement. The jointing consists of some medium (3–10 m long) and many small (short) joints causing great variation in block sizes, as is seen on the right figure.

The method to be used for measuring block size depends on the local conditions and the availability of such measurements. For instance, in the planning stage, where the rock surface is hidden by soil or weathering, core drillings, shafts, adits or geophysical measurements are used for assessing block size. During construction, however, the rock mass conditions can easily be observed in the tunnel, mine, shaft or cutting (if not covered by shotcrete or concrete lining). In such cases more accurate measurements are possible.

Table 1 outlines some methods for block size measurements. For all measurements, it is important to select the method yielding representative recordings. In Chapter 8 correlations are given between various block size measurements. Thus, the required type of block size input (RQD, joints spacing, etc.) to be used in calculations can be found from different measurements; e.g. spacing or block volume can be found from volumetric joint ( $J_v$ ) registrations.

In the following chapters comments, recommendations and assessments are presented on the methods indicated in Table 1. Refraction seismic measurements present an interesting possibility to assume block sizes when the measurements can be linked to core drillings. This is especially of value in areas where the rock surface is covered by soil or water. Information on this method can be found in Palmstrom (1996b, 2001) and Palmström and Nilsen, 2000).

### 4. Joint spacing (S)

Joint spacing is the perpendicular distance between two joints within a joint set. Joint spacing is applied as one of six input parameters in the RMR (rock mass rating) system. “It is widely accepted that spacing of joints is of great importance in appraising a rock mass structure.

Table 1  
Some main methods for measuring block size

Measurements in rock surfaces	Measurements on drill cores	Refraction seismic measurements
Block size (volume of block) ( $V_b$ )	Rock quality designation (RQD)	Sound velocity of rock masses <sup>a</sup>
Volumetric joint count ( $J_v$ )	Fracture frequency <sup>a</sup>	
Joint spacing ( $S$ )	Joint intercept <sup>a</sup>	
Weighted joint density (wJd)	Weighted joint density (wJd)	
Rock quality designation (RQD) <sup>b</sup>	Block volume ( $V_b$ ) <sup>c</sup>	

<sup>a</sup> Not described in paper.

<sup>b</sup> Estimated from scan line measurements.

<sup>c</sup> In some sections with crushed rock.

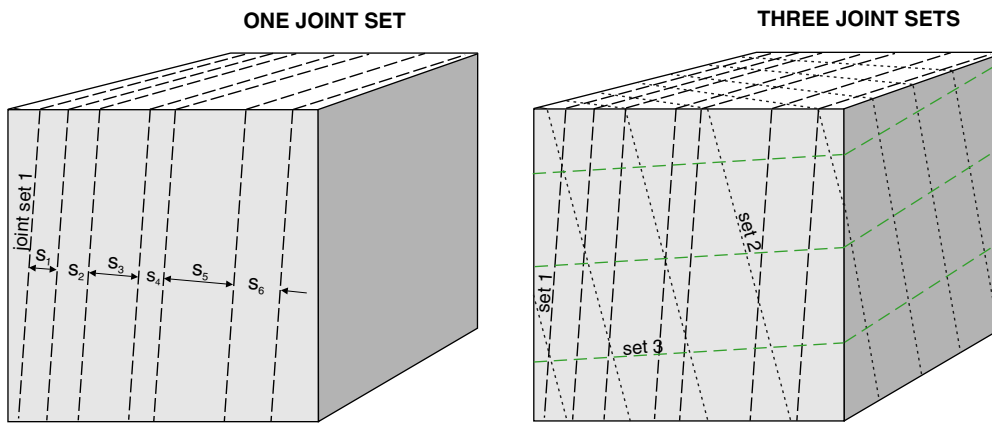

Fig. 3. Joint sets and joint set spacing.

*The very presence of joints reduces the strength of a rock mass and their spacing governs the degree of such a reduction.*” (Bieniawski, 1973)

The RMR applies ratings of joint spacing according to the classification by Deere (1968). When one distinct joint set occurs as in Fig. 3 (left), it is easy to measure the spacing. But when more than one joint set occur as in Fig. 3 (right), or for more complicated jointing pattern as in Fig. 1 or 2, Bieniawski (1973) did not indicate how to calculate the spacing. According to Edelbro (2003) “the lowest rating should be considered if there is more than one joint set and the spacing of joints varies”.

In other cases where an average joint spacing is used and more than one joint set occur, the following expression may be used:

$$S_a \approx \sqrt[3]{V_b}. \tag{11}$$

Here,  $V_b$  = block volume in  $m^3$ .

Some rock engineers apply the following expression for the average spacing of the joint sets (Fig. 3, right):

$$S_a = (S_1 + S_2 + S_3 + \dots + S_n)/n, \tag{12}$$

where  $S_1, S_2, S_3$ , etc. are average spacings for each of the joint sets. But Eq. (12) does not correctly characterize the joint spacing. The following example illustrate this:

**Example 1.** Three joint sets intersect at right angles with average spacings:  $S_1 = 0.1$  m,  $S_2 = 0.5$  m, and

$S_3 = 2$  m. The block volume  $V_b = S_1 \times S_2 \times S_3 = 0.1$   $m^3$ . Using Eq. (12) the overall average spacing  $S_a = 0.87$  m gives a block volume of  $V_b = S_a^3 = 0.65$   $m^3$  (which obviously is much too large).

### 5. Block volume ( $V_b$ )

Where individual blocks can be observed in a surface, their volumes can be directly measured from relevant dimensions by selecting several representative blocks and measuring their average dimensions (Fig. 4). For small blocks or fragments having volumes in  $dm^3$  size or less, this measurement is often the quickest of the methods, as it is easy to estimate the block size compared to registration of the many joints involved. Where three joint sets occur, the block volume is

$$V_b = \frac{S_1 \times S_2 \times S_3}{\sin \gamma_1 \times \sin \gamma_2 \times \sin \gamma_3}, \tag{13}$$

where  $S_1, S_2, S_3$  are the spacings in the three joint sets, and  $\gamma_1, \gamma_2, \gamma_3$  are the angles between the joint sets.

Table 2 shows the variation block volume for some angles between the joint sets found from Eq. (13).

As it is seldom that more than one of the angles is  $60^\circ$  or less, the inaccuracy imposed by a simplified measurement omitting the angles in Eq. (13) is limited.

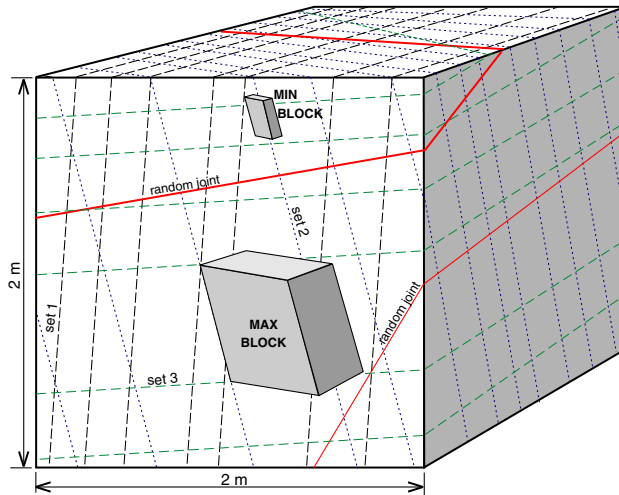

Fig. 4. Regular jointing with 3 joint sets and a few random joints. The minimum and maximum block size in a rock mass volume of 2 × 2 × 2 m (from Palmstrom, 2001).

In many cases, the blocks formed by the joints are irregular, e.g. when there are mostly random joints (Fig. 5). In such cases the block sizes cannot be estimated using joint spacings. Instead characteristic dimensions of each block can be measured or estimated. In other cases it is not possible to observe entire blocks in a rock exposure on the surface or in an underground opening; e.g. where less than three joint sets occur, and/or when the joint spacings are large. In such cases a rule of thumb may be used to make a block size estimate possible, by assuming a spacing of the joints five times the spacing of the main joint set seen. This is illustrated in the example below.

**Example 2.** Where only one joint set (with average spacing  $S_1$ ) can be seen:  $V_b \approx S_1 \times 5S_1 \times 5S_1 = 25 S_1^3$  (for  $S_1 = 1$  m,  $V_b = 25$  m<sup>3</sup>)

For two joint sets (with spacings  $S_1 = 1$  m and  $S_2 = 2$  m) at approx. right angle:  $V_b \approx S_1 \times S_2 \times 5S_1 = 5S_1^2 \times S_2 = 10$  m<sup>3</sup>.

The block volume can also be found in drill cores in cases where the fragments are small enough to be measured in the core, for example where crushed rocks occur.

Ideally, the variation of block sizes in a location should be given as a block distribution diagram (Fig. 6); however, for several reasons this is seldom possible. The block sizes have to be measured by observation one by one, either in rock surfaces, from scanlines, or from drill cores (instead of being sieved as can be done

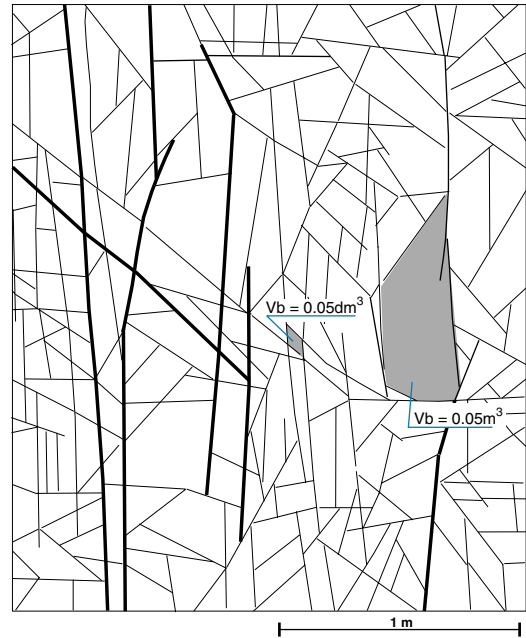

Fig. 5. The block volumes in Fig. 2 vary between approx.  $5 \times 10^{-5}$  m<sup>3</sup> and  $5 \times 10^{-2}$  m<sup>3</sup>. Average block size  $\approx 0.025$  m<sup>3</sup>.

for soils). From these measurements the apparent smallest and largest block can be reported (see Fig. 4), but often a *representative* or an *equivalent block size* is inconsistently recorded and used for input in rock engineering (see Fig. 7).

For information, the block volume can be classified as suggested by Palmstrom (1995):

Very small	$V_b = 10\text{--}200$ cm <sup>3</sup>
Small	$V_b = 0.2\text{--}10$ dm <sup>3</sup>
Moderate	$V_b = 10\text{--}200$ dm <sup>3</sup>
Large	$V_b = 0.2\text{--}10$ m <sup>3</sup>
Very large	$V_b > 10$ m <sup>3</sup>

### 6. Volumetric joint count ( $J_v$ )

The volumetric joint ( $J_v$ ) count was introduced by Palmstrom in 1974. Earlier, a similar expression for joint density measurements was applied by Bergh-Christensen (1968) as the number of joints in a blast round. Being a three-dimensional measurement for the density of joints,  $J_v$  applies best where well-defined joint sets occur.

Table 2  
Block volume for various angles between the joint sets

All angles = 90°	Two angles = 90° One angle = 60°	One angle = 90° Two angles = 60°	All angles = 60°	All angles = 45°
$V_b = V_{b_0} = S_1 \times S_2 \times S_3$	$V_b = 1.16V_{b_0}$	$V_b = 1.3V_{b_0}$	$V_b = 1.5V_{b_0}$	$V_b = 2.8V_{b_0}$

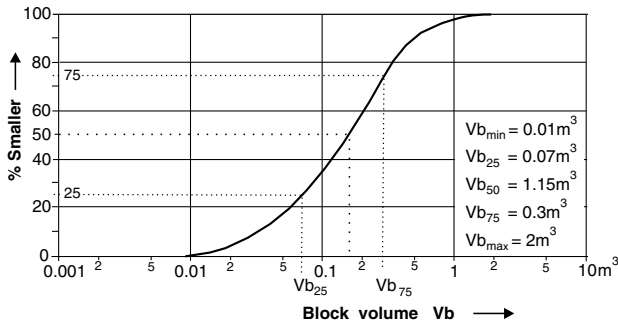

Fig. 6. Example of a distribution curve for block sizes (from Palmstrom, 2001).

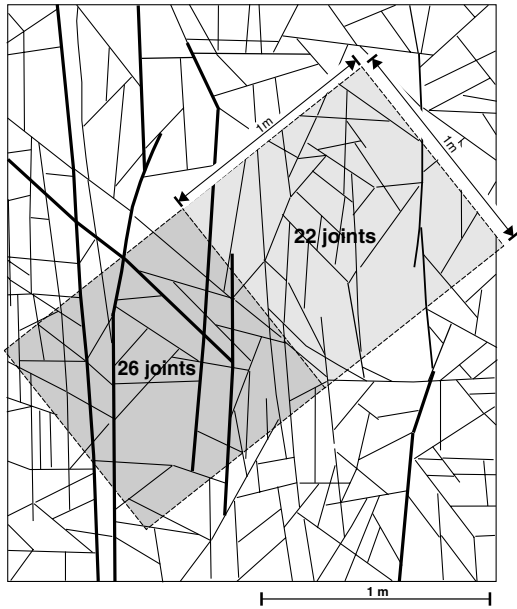

Fig. 7. Observation of the number of joints in the location of Fig. 2. The many short joints in this location cause inaccuracy of  $J_v$  (because its definition applies for joints longer than 1 m) with too high value of  $J_v$ . Therefore,  $J_v$  as defined in Eq. (15) does not characterize the degree of jointing correctly in this location.

$J_v$  is defined as the number of joints intersecting a volume of  $1 \text{ m}^3$ . Where the jointing occurs mainly as joint sets

$$J_v = 1/S_1 + 1/S_2 + 1/S_3 + \dots + 1/S_n, \quad (14)$$

where  $S_1$ ,  $S_2$  and  $S_3$  are the average spacings for the joint sets.

Random joints are not included in a particular joint set. As they may represent a significant part of the total number of discontinuities, “neglecting them would lead to erroneous quantification of the discontinuity nature of rock mass” (Grenon and Hadjigeorgiou, 2003). Palmstrom (1982) has presented an approximate rule of thumb correction for this with a spacing of 5 m for each random joint:

$$J_v = 1/S_1 + 1/S_2 + 1/S_3 + \dots + 1/S_n + N_r/(5\sqrt{A}), \quad (15)$$

where  $N_r$  is the number of random joints in the actual location and  $A$  is the area in  $\text{m}^2$ . Classification of the  $J_v$  is as follows:

	Degree of jointing					
	Very low	Low	Moderate	High	Very high	Crushed
$J_v =$	< 1	1–3	3–10	10–30	30–60	> 60

Similar to RQD, the volumetric joint count ( $J_v$ ) is by definition an average measurement for the actual rock mass volume measured, expressing the number of joints occurring in this volume. However, as all joints seldom can be observed (counted) in a volume,  $J_v$  is often given as a range from what can be observed, for example, where it is measured from the variation in the spacings for each joint set. Table 3 presents an example based on in Fig. 4, where  $J_v$  is found from the smaller and for the larger joint spacings for each joint set.

### 6.1. Correlation between $J_v$ and $V_b$

As has been shown by Palmstrom (1995, 1996a) the correlation between the block volume ( $V_b$ ) and the volumetric joint count ( $J_v$ ) is

$$V_b = \beta \times J_v^{-3}, \quad (16)$$

where  $\beta$  is the block shape factor, having the following characterization:

- for equidimensional (cubical or compact) blocks  $\beta = 27$ ,
- for slightly long (prismatic) and for slightly flat (tabular) blocks  $\beta = 28–32$ ,
- for moderately long and for moderately flat blocks  $\beta = 33–59$ ,
- for long and for flat blocks  $\beta = 60–200$ ,
- for very long and for very flat blocks  $\beta > 200$ .

A common value for  $\beta = 36$ .

Palmstrom (1995) has shown that the block shape factor ( $\beta$ ) may crudely be estimated from

$$\beta \approx 20 + 7a_3/a_1, \quad (17)$$

where  $a_1$  and  $a_3$  are the shortest and longest dimensions of the block.

More information on the block shape factor has been presented by Palmstrom (1995).

### 6.2. $J_v$ found from weighted joint density

In addition to surface observations, the  $J_v$  can be measured from drill cores or surface observations, as shown by Palmstrom (1995, 1996a, 2001). This measurement, called *weighted joint density* (wJd), applies an

Table 3  
Example of  $J_v$  and  $V_b$  measurements from joint sets observed in a rock surface

Jointing		Variation of joint set spacing and frequency				Average spacing (m)	Average frequency
		min spacing (m)	max spacing (m)	max frequency	min frequency		
Joint set 1,	S1	0.2	0.4	5.0	2.5	0.3	3.3
Joint set 2,	S2	0.4	0.6	2.5	1.7	0.5	2.0
Joint set 3,	S3	0.3	0.5	3.3	2.0	0.4	2.5
2 random joints (in 1m <sup>2</sup> surface)		5.0 <sup>a</sup>		2/5 = 0.4	2/5 = 0.4	5.0 <sup>b</sup>	2/5 = 0.4
Calculations	Volumetric joint count $J_v =$ ( $J_v = \Sigma$ frequencies)			<b>11.2</b> (max $J_v$ )	<b>6.6</b> (min $J_v$ )		<b>8.2</b> (average $J_v$ )
	Block volume <sup>b</sup> $V_b =$	0.024m <sup>3</sup> (min $V_b$ )	0.12m <sup>3</sup> (max $V_b$ )			0.06m <sup>3</sup> (average $V_b$ )	
<sup>a</sup> for random joints, a spacing of 5m for each random joint is used in the $J_v$ calculation;							
<sup>b</sup> for joint intersections at approx. right angles							

adjustment value for the orientation of the joints relative to the surface or the drill core. The wJd is a further development of the works by Terzaghi (1965).

In principle, the weighted jointing method is based on measuring the angle ( $\delta$ ) between each joint and the surface or the borehole, as is shown in Fig. 8.

To simplify the observations, the angles have been grouped into four intervals, for each an average value

of  $f_i$  (from the ratio  $1/\sin\delta$ ) has been selected, as presented in Table 5. The definition of the wJd is then:

–for two – dimensional measurements in rock surfaces :  $wJd = \frac{1}{\sqrt{A}} \sum f_i$ , (18)

–for one – dimensional measurements along boreholes :  $wJd = \frac{1}{L} \sum f_i$ , (19)

where  $A$  is the size of the observation area and  $L$  is the length of section measured in the borehole.

Thus, the volumetric joint count  $J_v \approx wJd$  can be found directly from core logging or surface observations. After some training the wJd core logging has shown to be relatively easy and quick to perform. Example 3 shows how to estimate wJd from borehole cores.

**Example 3.** In Fig. 10 the wJd is found from the observations in Table 4:

Sonmez et al. (2004) have given the following comments of the wJd:

- (a) When wJd is assessed by window sampling (i.e. 2-D observations of rock surfaces), it changes with the ratio of the side lengths; for this reason the use of a square window is recommended.

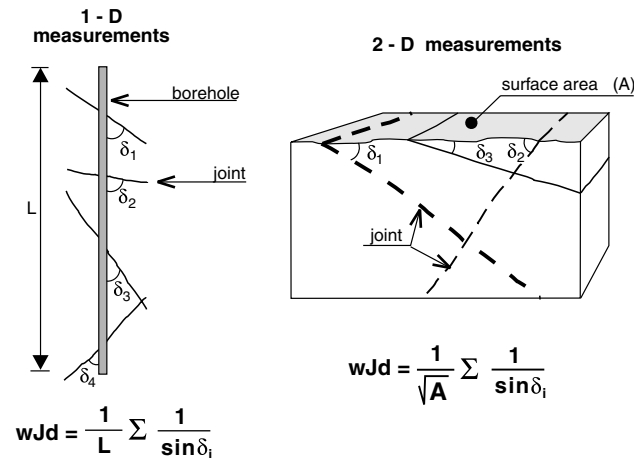

Fig. 8. The definitions of wJd measurement for borehole and surface registrations. (Palmstrom, 1995).

Table 4  
Observations of joints along a drill core to calculate the wJd

Angle interval	Factor $f_i$	Section 1		Section 2	
		Number of joints ( $N$ )	Value $f_i \times N$	Number of joints ( $N$ )	Value $f_i \times N$
$\delta > 60^\circ$	1	3	3	5	5
$\delta = 30-60^\circ$	1.5	7	10.5	7	10.5
$\delta = 15-30^\circ$	3.5	0	0	0	0
$\delta < 15^\circ$	6	1	6	1	6
		$wJd = \Sigma(f_i \times N) =$	19.5	$wJd = \Sigma(f_i \times N) =$	21.5

Table 5  
Angle intervals and ratings of the factor  $f_i$  in each interval

Angle interval (between joint and borehole or surface)	$1/\sin\delta$	Chosen rating of the factor $f_i$
$\delta > 60^\circ$	$< 1.16$	1
$\delta = 30\text{--}60^\circ$	$1.16\text{--}1.99$	1.5
$\delta = 15\text{--}30^\circ$	$2\text{--}3.86$	3.5
$\delta < 15^\circ$	$> 3.86$	6

- (b) The joints nearly parallel to the observation surface are not well represented in the sampling area. Also the joints nearly parallel to the borehole axis are not sampled. Therefore, the wJd will be conservative.
- (c) A minimum area required for the determination has to be defined.
- (d) The angle  $\delta$  between the joint surface and the borehole axis has to be the maximum, otherwise, the apparent joint spacing is considered instead of the true spacing.

**7. Rock quality designation**

The rock quality designation (RQD) was developed by Deere (1963) to provide a quantitative estimate of rock mass quality from drill core logs. It is defined as “the percentage of intact core pieces longer than 100 mm in the total length of core.” The core should be at least NX size (54.7 mm in diameter) and should be drilled with a double-tube core barrel.

The RQD is an easy and quick measurement as only certain core pieces (longer than 10 cm) are included, see Figs. 9 and 10. It is, therefore, frequently applied in core logging and is often the only method used for measuring the degree of jointing along the core drill hole. The most important use of RQD is as a component of the RMR and Q rock mass classifications.

RQD gives an average measurement of the degree of jointing along the actual section (core run); therefore, it is no meaning saying that RQD varies between 10 and 20 for that section. Measured along several sections, the RQD has, of course, a variation.

**7.1. Limitations of the RQD**

As has been mentioned by several authors (Bieniawski, 1973, 1984; Edelbro, 2003) and known by most people involved in core logging and rock engineering, the RQD has several limits. For example, RQD = 0 where the joint intercept (distance between the joints in the drill cores) is 10 cm or less, while RQD = 100 where the distance is 11 cm or more, see Fig. 11. Another drawback is that the RQD gives no information of the core pieces <10 cm excluded, i.e. it does not matter whether the discarded pieces

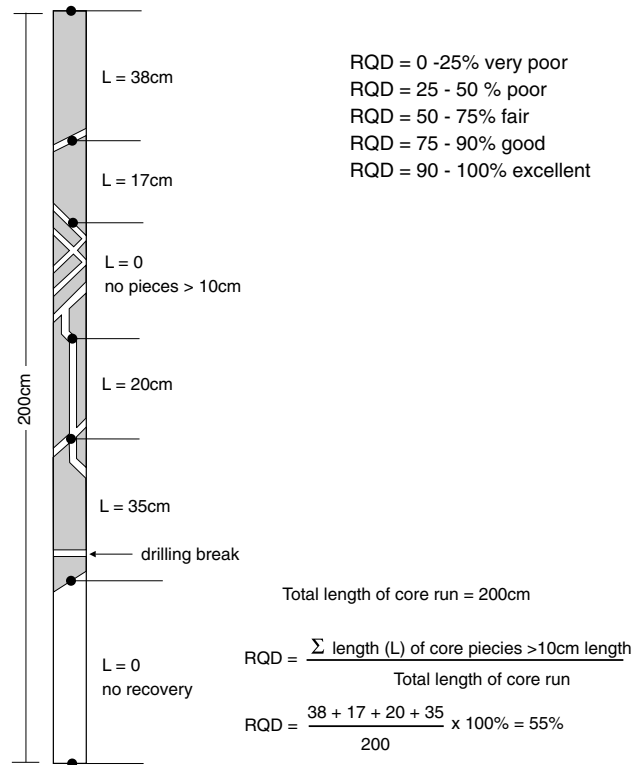

Fig. 9. Procedure for measurement and calculation of RQD (slightly modified after Deere, 1989).

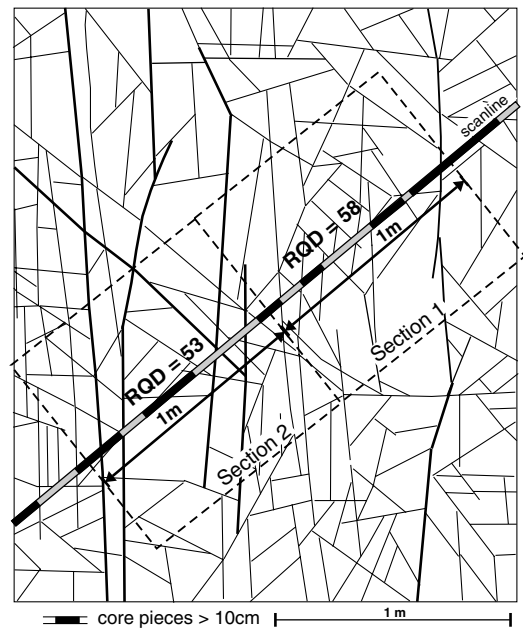

Fig. 10. By applying a scanline in Fig. 2, the RQD-values can be found. “Core pieces” > 10 cm are shown in black. However, this measurement does not show the large variation in block sizes as is seen in Fig. 5.

are earth-like materials or fresh rock pieces up to 10 cm length.

Similar to all types of one-dimensional measurements (boreholes and scanlines) RQD is directional, but due to

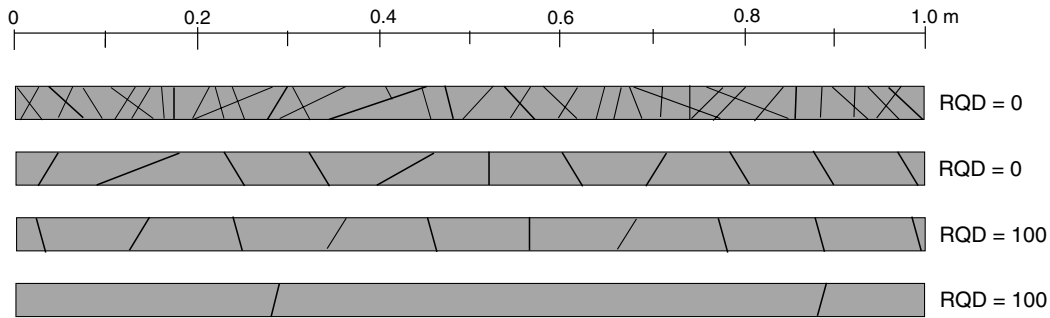

Fig. 11. Examples of minimum and maximum values of RQD for various joint densities along drill cores (from Palmstrom, 2001).

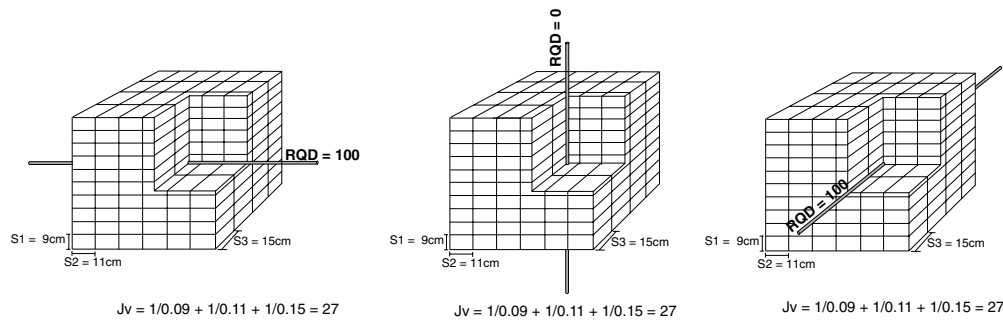

Fig. 12. Three boreholes penetrate the same rock mass in different directions. As seen, the RQD can be both 0 and 100.

its definition it is more sensitive to the hole or line direction than joint spacing or fracture frequency measurements. This has been shown by Choi and Park (2004) for Korean conditions. Fig. 12 shows three extreme examples where the RQD has values 0 and 100 for the same type and degree of jointing only due to the direction of the borehole.

Simulations of directional errors of RQD using computer spreadsheets as shown in Fig. 16, have been performed by Palmstrom (1995) and Palmstrom et al. (2002).

7.2. Correlation between RQD and  $J_v$

It turned out difficult to relate RQD to other measurements of jointing, as RQD is a one-dimensional, averaged measurement based solely on core pieces larger than 10 cm. Simulations using blocks of the same size and shape penetrated by a line (i.e. borehole) at different angles have been used for such estimations. The first attempts were made by Palmstrom (1974) when the volumetric joint count ( $J_v$ ) was introduced. The following, simple expression between RQD and  $J_v$  was then presented:

$$RQD = 115 - 3.3J_v, \tag{20}$$

( $RQD = 0$  for  $J_v > 35$ , and  $RQD = 100$  for  $J_v < 4.5$ ).

This expression was included in the introduction of the  $Q$  system by Barton et al. (1974). As seen in Fig. 13, the correlation between RQD and  $J_v$  is rather poor, especially, where many of the core pieces have lengths

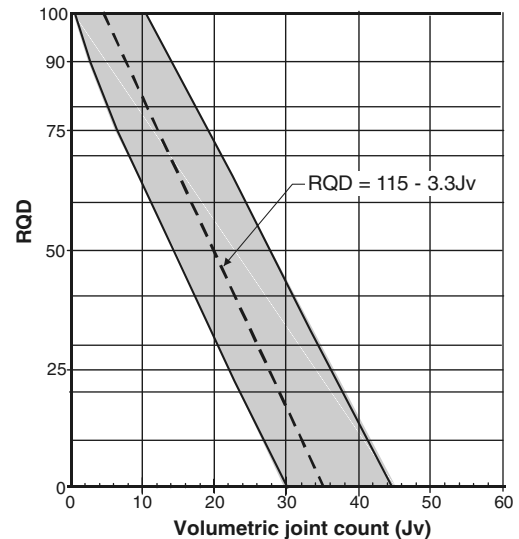

Fig. 13. Correlation  $J_v$ -RQD with the variation range (modified into linear scale for  $J_v$ , from Palmstrom, 1974).

around 0.1 m. However, when  $J_v$  is the only joint data available (no borehole or scanline logging), Eq. (13) has been found to be an alternative transition for finding RQD from  $J_v$ , where, for instance, RQD is required in the  $Q$  and the RMR classification systems.

Fig. 14 shows the results from core logging of a 223 m long core drill hole in gneiss, mostly with few joints (large block sizes) where RQD, and  $J_v$  was measured (from weighted joint density,  $J_v = wJd$ ). Also this example shows poor connection between RQD and  $J_v$ .

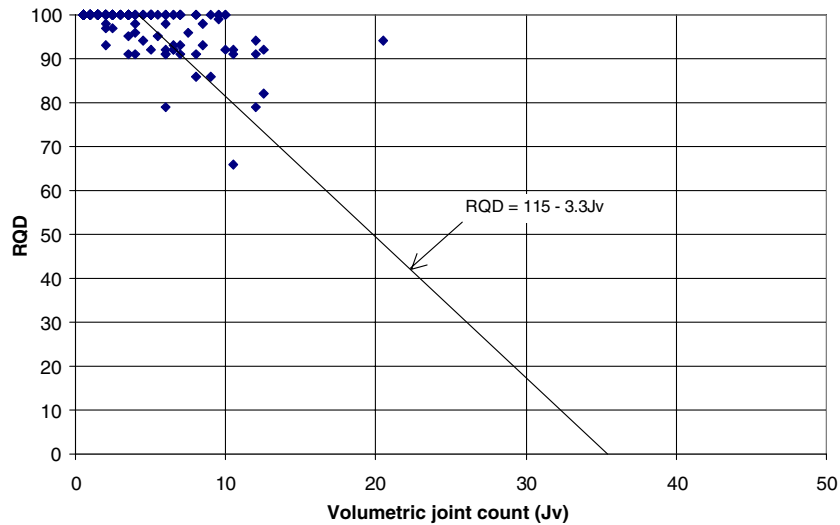

Fig. 14. Results from logging of a 223 m long core drill hole at Ormen Lange petrochemical terminal, Norway, where both RQD and wJd measurement were performed.

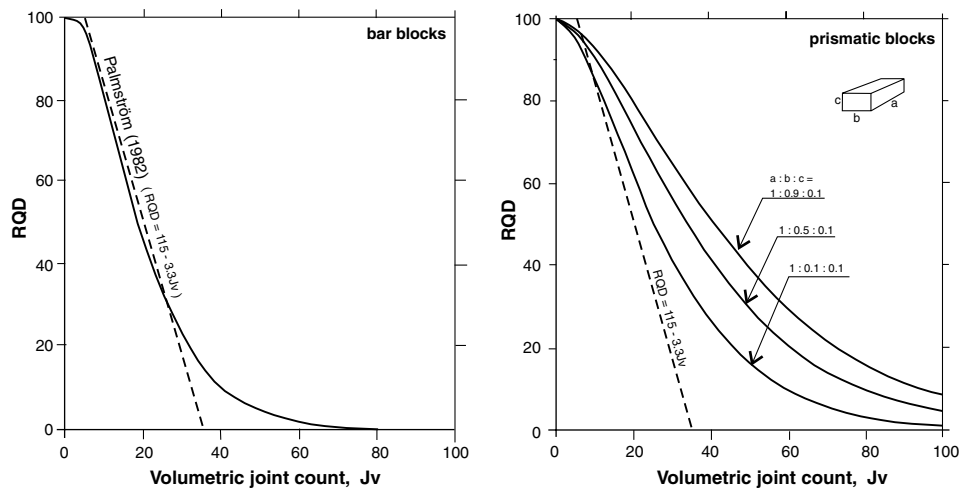

Fig. 15. Correlation  $J_v$ -RQD, modified from Sen and Eissa (1991) for bar (long) blocks (left figure) and for prismatic blocks.

Hudson and Priest (1979) have presented the following, mathematical relation equation between RQD and fracture frequency:

$$RQD = 100e^{-0.1\lambda}(1 + 0.1\lambda), \tag{21}$$

where  $\lambda$  = the total joint frequency.

Sen and Eissa (1991) further developed this equation linking it to block sizes and block shapes, as shown in Fig. 15. As seen, the RQD varies significantly for the various types of blocks. The figure also shows a lowering of the RQD value with increasing difference between the lengths of the block sides (i.e. joint spacings).

The fact that RQD = 0 for a wide range of  $J_v$ , even for  $J_v$  as low as  $J_v = 17$  in Fig. 16, complicates any correlation between RQD and other joint density measurements.

The following two simplified examples illustrate the problems in the RQD- $J_v$  correlations, as presented in Fig. 17:

**Example 4.** For blocks with shape a:b:c = 1:0.9:0.1

Along 1 m of a borehole perpendicular to the joints with smallest spacing, the following blocks occur:

- A. 2 blocks, each of dimension 100 × 90 × 10 cm, and 10 blocks of 80 × 72 × 8 cm give RQD = 20 and  $J_v = 14.5$
- B. 2 blocks, each of dimension 100 × 90 × 10 cm, and 20 blocks of 40 × 36 × 4 cm give RQD = 20 and  $J_v = 27$
- C. 2 blocks, each of dimension 100 × 90 × 10 cm, and 40 blocks of 20 × 18 × 2 cm give RQD = 20 and  $J_v = 51$
- D. 2 blocks, each of dimension 100 × 90 × 10 cm, and 80 blocks of 10 × 9 × 1 cm give RQD = 20 and  $J_v = 99$

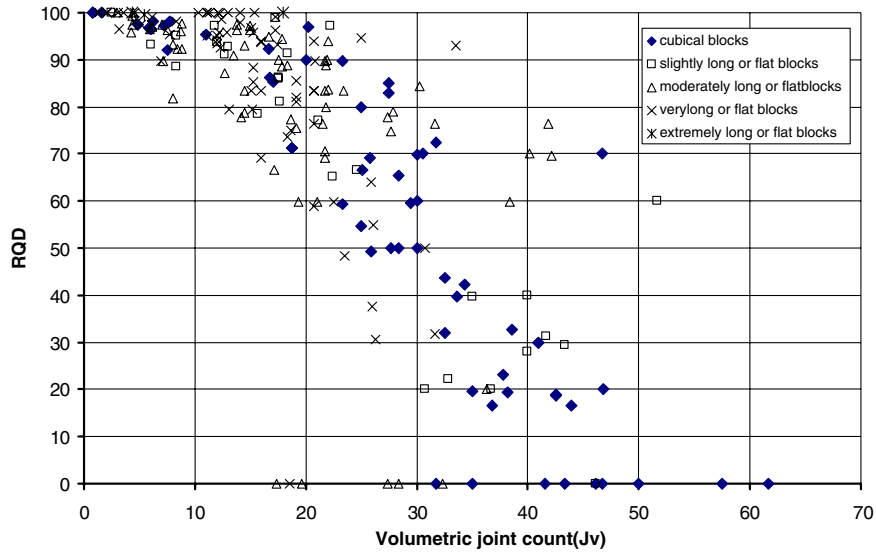

Fig. 16. Correlations between RQD and  $J_v$ . Results from a computer calculation of lines penetrating blocks of the same size at different angles (from Palmstrom et al., 2002).

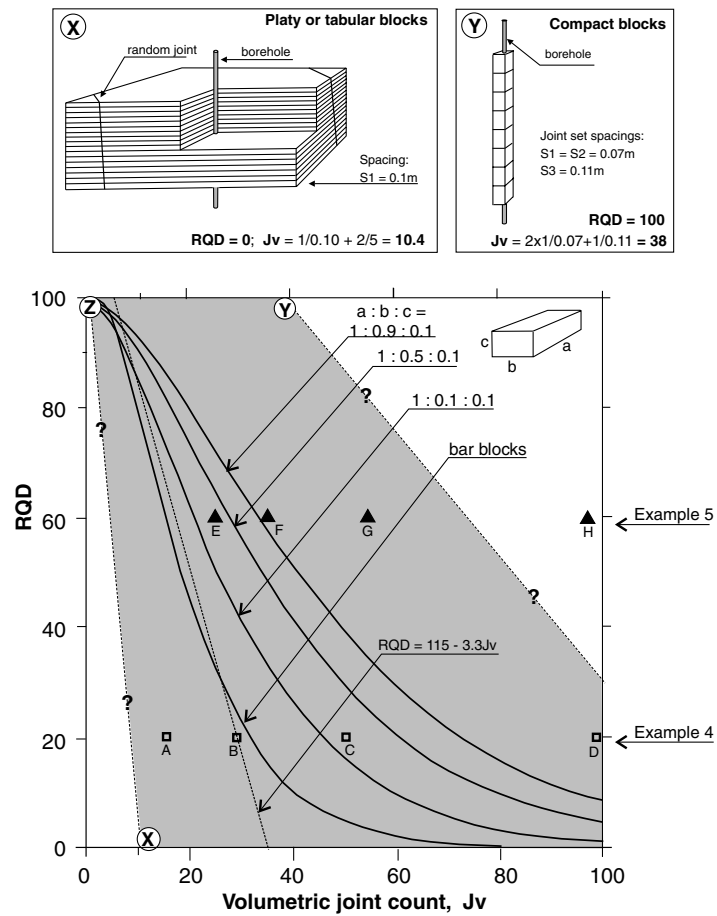

Fig. 17. The approximate correlation between RQD and  $J_v$  based on Figs. 14–16. The points (X) and (Y) show extreme jointing conditions to indicate the variation limits of RQD.

**Example 5.** For blocks with shape a:b:c = 1:0.1:0.1

Along 1 m of a borehole perpendicular to the joints with smallest spacing, the following blocks occur:

- E. 6 blocks of dimension 100 × 10 × 10 cm, and 5 blocks of 80 × 8 × 8 cm give RQD = 60 and  $J_v = 23$
- F. 6 blocks of dimension 100 × 10 × 10 cm, and 10 blocks of 40 × 4 × 4 cm give RQD = 60 and  $J_v = 34$
- G. 6 blocks of dimension 100 × 10 × 10 cm, and 20 blocks of 20 × 2 × 2 cm give RQD = 60 and  $J_v = 55$
- H. 6 blocks of dimension 100 × 10 × 10 cm, and 40 blocks of 10 × 1 × 1 cm give RQD = 60 and  $J_v = 97$

Note that the jointing used in the examples above seldom occur in situ, – especially the very thin prismatic blocks of 1 cm thickness – but they are used here to indicate the problems in finding a correlation between  $J_v$  and RQD.

In order to estimate the limits in the correlation between RQD and  $J_v$ , the cases X and Y in Fig. 17 have been included, where

- X presents the theoretical minimum of  $J_v$  (11) for RQD = 0 (for tabular blocks with spacing  $S_1 = 10$  cm and wide spacings for  $S_2$  and  $S_3$ ), and
- Y is the theoretical maximum of  $J_v$  ( $\approx 38$ ) for RQD = 100 (for compact (cubical) blocks). The theoretical minimum (Z) of  $J_v$  is close to zero for very large blocks.

As shown, the minimum value (X) of  $J_v$  for RQD = 0 is lower than the maximum  $J_v$  value (Y) for RQD = 100 (which also is the case in Fig. 16). In the interval  $J_v = 15–30$  the RQD can have values of both 0 and 100 or in between. Thus, in this interval RQD may have any value.

Both Figs. 16 and 17 show that RQD is an inaccurate measure for the degree of jointing. As it is often easier to measure the  $J_v$  in a rock surface than the RQD, RQD is frequently found from measurements of  $J_v$  using Eq.

(13). By this, an inaccuracy or error may be introduced in the calculation.

When starting to analyse the ability of RQD to characterize the degree of jointing, it was assumed that an appropriate correlation exists between RQD and  $J_v$ . From the evaluations presented above it appears, however, that this is not the case. This is in line with the findings of Grenon and Hadjigeorgiou (2003) from in situ jointing measurements in Canadian mines: “This reflects the fact that RQD is insensitive when the rock mass is moderately fractured. One has to keep in mind that RQD values are a function of the total frequency which is highly sensitive to sampling line orientation.”

Fig. 18 illustrates assumed limits and two (inaccurate) correlations between  $J_v$  and RQD. The new equation

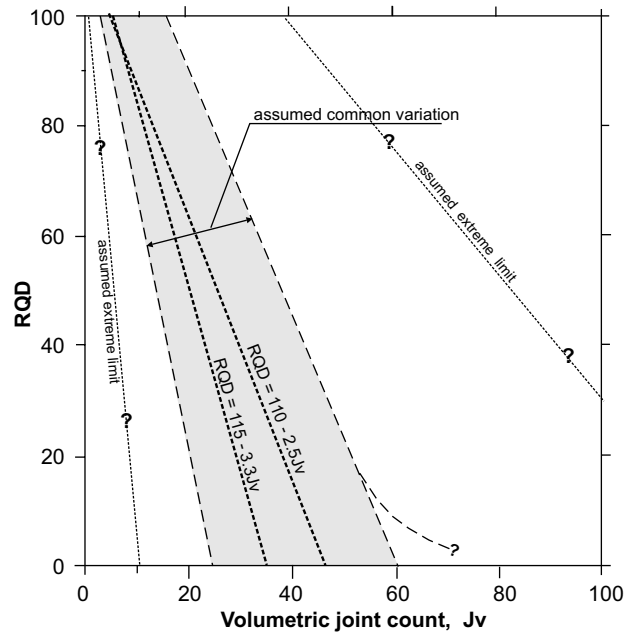

Fig. 18. The probable common variation for RQD– $J_v$  and suggested equations.

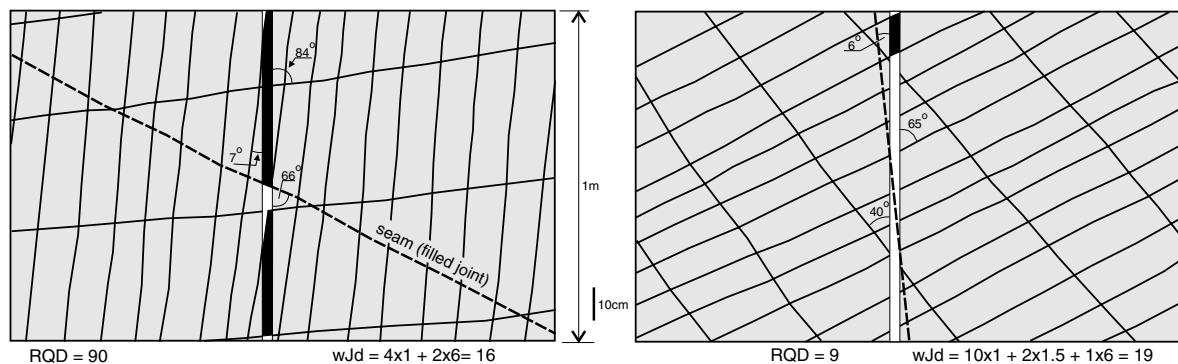

Fig. 19. Difference between the orientation of a borehole relative to the joints. (The black thick lines show core pieces > 10 cm) With the same jointing in both cases the measurement should give the same value for both cases. As seen, wJd are in the same range (16 and 19) for both borehole cases, while RQD shows a great difference (10 and 90). For calculation of wJd, see Fig. 8 and Table 5.

$$RQD = 110 - 2.5J_v, \tag{22}$$

probably gives a more appropriate average correlation than the existing Eq. (20), which may be representative for the more long or flat blocks, while Eq. (22) is better for blocks of cubical (bar) shape. It has been chosen to use Eq. (22) in the remaining part of this paper.

### 7.3. Comparison between RQD and wJd

The directional errors in one-dimensional measurements in boreholes mentioned for the RQD measurement are partly compensated for in the wJd measurements as indicated in Fig. 19, which shows an example of RQD and wJd measurements for two boreholes in different directions to the same jointing. (Ideally, the  $J_v$  as well as the RQD should have the same value in the two measurements.)

Fig. 20 shows the results from logging of the degree of jointing in drill cores by the  $J_v$  and by the RQD in practice. Contrary to the RQD, the  $J_v$  shows variation in all the three boreholes. Both Figs. 19 and 20 show the limitation of RQD to correctly characterize the block size.

### 7.4. RQD/Jn as a measure for block size

The limits of RQD to characterize large blocks or very small blocks may be reduced by introducing adjustments to it, as is done in the Q-system by the quotient RQD/Jn, which uses ratings for the number of joint set (Jn) as shown in Table 6.

The values of Jn varies from 0.5 to 20. According to Barton et al. (1974), Grimstad and Barton (1993) and several other papers presented by Barton, the ratio RQD/Jn varies with the block size.

As RQD/Jn in Fig. 21 varies largely for the block volume ( $V_b$ ), this expression is an inaccurate characterization of block size, though it extends the range the block sizes compared to RQD alone (Hadjigeorgiou

Table 6

The joint set number	Jn = 0.5–1
Massive, no or few joints	2
One joint set	3
One joint set plus random	4
Two joint sets	6
Two joint sets plus random	9
Three joint sets	12
Three joint sets plus random	15
Four or more joint sets, heavily jointed, "sugar-cube", etc.	20
Crushed rock, earth-like	

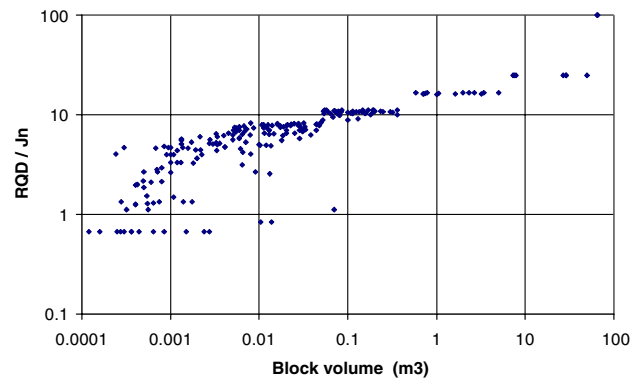

Fig. 21. Block volume RQD/Jn based on the same conditions as for Fig. 16. Note that both axes are logarithmic (from Palmstrom et al., 2002).

et al., 1998) (another problem connected to this expression is that the number of joint sets is often prone to wrong characterizations by the users. Many observers apply all joint sets observed in a region, while Jn is the number of joint sets at the actual location.)

Grenon and Hadjigeorgiou (2003) have from their in situ investigations in Canadian mines also concluded that the expression RQD/Jn is inaccurate in characterizing block size.

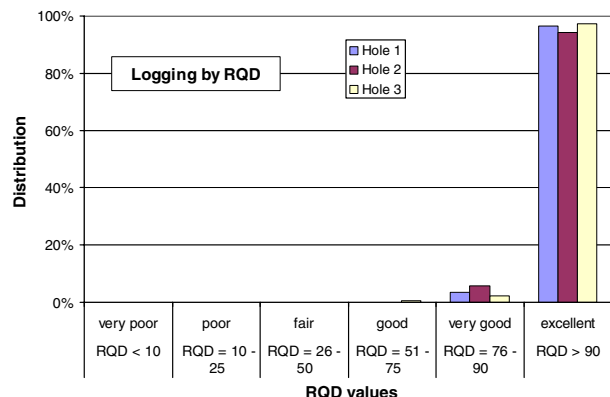
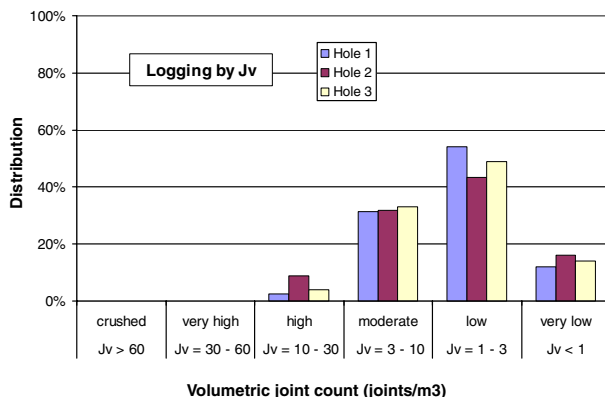

Fig. 20. Measurements of  $J_v$  (=wJd) and RQD in 3 boreholes with total length of 450 m in gneiss and amphibolite.

**8. Correlations between different block size measurements**

When RQD is used as input (e.g. to the  $Q$  and RMR systems) it may be estimated from  $J_v$  or  $V_b$  measurement. A drawback when using RQD is, however, that it only covers a limited part of the range of jointing (see Fig. 22). On the other hand, it should be mentioned that the range covered by RQD represents a large part of blocky and broken rock where the classification systems work best.

Similarly, through a comprehensive mapping program in five Canadian mines, Grenon and Hadjigeorg

giou (2003) have found that contrary to the RQD, the volumetric joint count, the in situ block volume, as well as the trace length of joint per area and the area of joint per volume provide proper jointing characterizations of rock masses.

The findings above are in good accordance with the following excerpt from GeoEng2000 workshop on classification:

*“An example of problems associated with applying classification systems to characterise the rock mass is best shown through the use of RQD,  $J_n$  and joint spacing for*

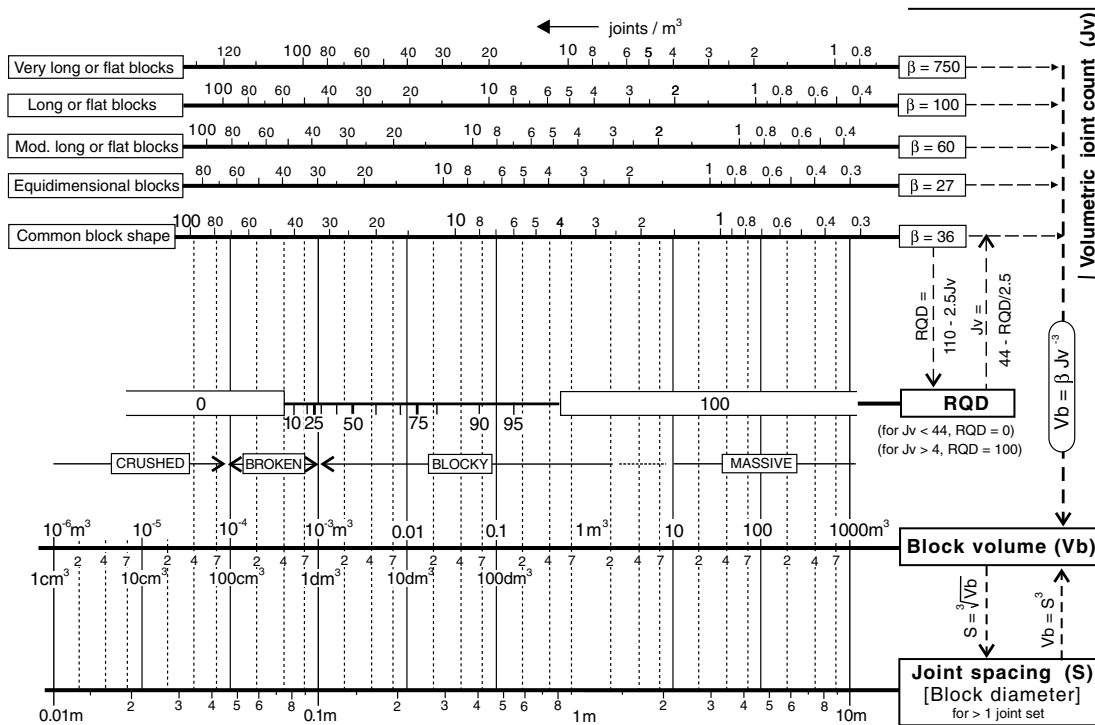

Fig. 22. Correlations between various measurements of block size. The block volume ( $V_b$ ) and volumetric joint count ( $J_v$ ) cover a significantly larger interval of the jointing than the RQD. The best correlation exists between  $J_v$  and  $V_b$ . However, also the block shape influences on the correlations. Example: For a block size of  $V_b = 0.1 \text{ m}^3$  the  $J_v = 6.5$  when block shape factor  $\beta = 27$ ; but  $J_v = 9$  when  $\beta = 100$ .

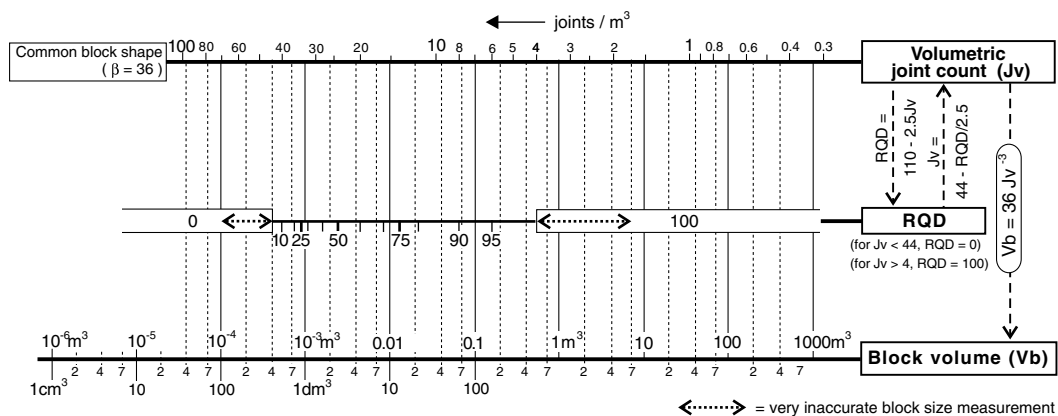

Fig. 23. Correlations between different methods for block size measurements.

characterising the pattern and density of jointing. These terms do a poor job of quantifying block size. RQD is insensitive to changes in joints per cubic metre ( $J_v$ ) greater than  $5 \text{ m}^{-1}$  (Milne et al., 1998). The number of joint sets in the rock mass can also be difficult to quantify and can easily vary based on the scale of the engineering project. A measure of joint spacing is a directionally dependent term, which cannot assess highly anisotropic joint spacing conditions. A block size/block volume calculation or estimate of  $J_v$  does a much more quantitative job of estimating block size.”

## 9. Conclusions

Measurements of the block size are often difficult and therefore encumbered with imprecise registrations. The various types of jointing in rock masses require often different types of measurements to arrive at the best possible recordings. Fig. 23 shows correlations between some of these measurements.

Where less than three joint sets occur, it is often expected that defined blocks will not be found. However, in most cases random joints or other weakness planes will contribute to define blocks. Also, where the jointing is irregular, or many of the joints are discontinuous, it can be difficult to recognise the actual size and shape of individual blocks. Therefore, the block size and shape have sometimes to be determined from reasonable simplifications.

As the joint spacings generally vary greatly, the difference in size between the smaller and the larger blocks in a location can be significant. Therefore, the characterization of the block volume should be given as an interval rather than a single value. RQD and  $J_v$  are less suitable for this, as they per definition express average of the jointing in a location. Variations of block sizes in a volume expressed by RQD can, however, be found from boreholes or scanlines in different directions.

It has been shown that it is a poor correlation between the RQD and other types of block size measurements. Being discontinuous by definition, RQD is not very suitable for correlations with other measurements. A new correlation between RQD and  $J_v$  has been presented as  $\text{RQD} = 110 - 2.5J_v$  (for  $J_v$  between 4 and 44), which may give somewhat better results than the commonly used  $\text{RQD} = 115 - 3.3J_v$ . But still there may be severe inaccuracies in the RQD to characterize block size, as have been mentioned above and indicated on Fig. 23.

Caused by the above, the application of RQD in rock engineering calculations may lead to inaccuracy or errors. RQD should therefore be applied with great care. Consequently, while “RQD is a practical parameter for core logging, it is not sufficient on its own to provide an

adequate description of a rock mass”. (Bieniawski, 1984; Milne et al., 1998).

Both the  $Q$  and the RMR classification systems would be improved if input of other block size measurements than RQD had been used. On the other hand, the RQD is often sufficient for stability and rock support estimates in blocky ground, while when used for other purposes where more accurate results are required, the use of RQD in the RMR and  $Q$  systems may cause severe inaccuracies.

People involved in jointing characterization should be better informed how to perform adequate block size, joint density, and block volume measurements, also knowing the limitation in the RQD. In general, more efforts should be made to work out instructions and information on the block size measurements.

## Acknowledgement

The author wishes to thank Dr. Olav T. Blindheim for useful comments. Many thanks also to the two referees who have given valuable critical comments and suggestions.

## References

- Barton, N., Lien, R., Lunde, J., 1974. Engineering classification of rock masses for the design of rock support. *Rock Mechanics* 6, 189–236.
- Barton, N., 1990. Scale effects or sampling bias? In: *Proceedings of the International Workshop Scale Effects in Rock Masses*, Balkema Publishers, Rotterdam, pp. 31–55.
- Bergh-Christensen, J., 1968. On the blastability of rocks. Lic. Techn. Thesis, Geological Institute, Technical University of Norway, Trondheim, 320 p (in Norwegian).
- Bieniawski, Z.T., 1973. Engineering classification of jointed rock masses. *Transactions of the South African Institution of Civil Engineers* 15 (12), 335–344.
- Bieniawski, Z.T., 1978. Determining rock mass deformability: Experience from case histories. *International Journal of Rock Mechanics Mineral Science & Geomechanics Abstract* 15, 237–247.
- Bieniawski, Z.T., 1984. *Rock Mechanics Design in Mining and Tunneling*. A.A. Balkema, Rotterdam, p. 272.
- Choi, S.Y., Park, H.D., 2004. Variation of the rock quality designation (RQD) with scanline orientation and length: a case study in Korea. *International Journal of Rock Mechanics & Mining Sciences* 41, 207–221.
- Dearman, W.R., 1991. *Engineering Geological Mapping*. Butterworth-Heinemann Ltd, Oxford.
- Deere, D.U., 1963. Technical description of rock cores for engineering purposes. *Felsmechanik und Ingenieurgeologie* 1 (1), 16–22.
- Deere, D.U., 1968. Geological considerations. In: Stagg, K.G., Zienkiewicz, O.C. (Eds.), *Rock Mechanics in Engineering Practice*. Wiley, London, pp. 1–20.
- Deere, D.U., 1989. Rock quality designation (RQD) after 20 years. US Army Corps Engrs. Contract Report GL-89-1. Waterways Experimental Station, Vicksburg, MS.

- Edelbro, C., 2003. Rock mass strength – a review. Technical Report, Luleå University of Technology, 132p.
- GeoEng2000 workshop on classification systems, 2000. The reliability of rock mass classification used in underground excavation and support design. *ISRM News* 6(3), 2.
- Goodman, R.E., 1993. *Engineering Geology. Rock in Engineering Construction*. Wiley, New York, p. 385.
- Grenon, M., Hadjigeorgiou, J., 2003. Evaluating discontinuity network characterization tools through mining case studies. *Soil Rock America 2003*, Boston 1, 137–142.
- Grimstad, E., Barton, N., 1993. Updating the Q-system for NMT. In: *Proceedings of the International Symposium on Sprayed Concrete*, Fagernes, Norway 1993, Norwegian Concrete Association, Oslo, 20 pp.
- Hadjigeorgiou, J., Grenon, M., Lessard, J.F., 1998. Defining in situ block size. *CIM Bulletin* 91 (1020), 72–75.
- Hoek, E., Brown, E.T., 1980. Empirical strength criterion for rock masses. *Journal of Geotechnical Engineering Division, ASCE* 106(GT9), 1013–1035.
- International Society for Rock Mechanics (ISRM), Commission on standardization of laboratory and field tests, 1978. Suggested methods for the quantitative description of discontinuities in rock masses. *Int. J. Rock Mech. Min. Sci. & Geomech. Abstr* 15(6), 319–368.
- Hoek, E., 1994. The challenge of input data for rock engineering. Letter to the editor. *ISRM, News Journal*, 2, No. 2, 2 p.
- Hudson, J.A., Priest, S.D., 1979. Discontinuities and rock mass geometry. *International Journal of Rock Mechanics Mining Science & Geomechanics Abstr.* 16, 339–362.
- Milne, D., Hadjigeorgiou, J., Pakalnis, R., 1998. Rock mass characterization for underground hard rock mines. *Tunnelling and Underground Space Technology* 13 (4), 383–391.
- Palmstrom, A., 1974. Characterization of jointing density and the quality of rock masses. Internal report, A.B. Berdal, Norway, 26 p (in Norwegian).
- Palmstrom, A., 1982. The volumetric joint count – A useful and simple measure of the degree of rock mass jointing. In: *IAEG Congress*, New Delhi V.221-V.228.
- Palmstrom, A., 1995. RMI – a rock mass characterization system for rock engineering purposes. PhD thesis, University of Oslo, Department of Geology, 400 pp.
- Palmstrom, A., 1996a. The weighted joint density method leads to improved characterization of jointing. In: *International Conference on Recent Advances in Tunnelling Technology*, New Delhi, India, 6 p.
- Palmstrom, A., 1996b. Application of seismic refraction survey in assessment of jointing. In: *International Conference on Recent Advances in Tunnelling Technology*, New Delhi, India, 9 p.
- Palmström, A., Nilsen, B., 2000. *Engineering Geology and Rock Engineering. Handbook*. Norwegian Rock and Soil Engineering Association, p. 250.
- Palmström, A., Singh, R., 2001. The deformation modulus of rock masses – comparisons between in situ tests and indirect estimates. *Tunnelling and Underground Space Technology* 16 (3), 115–131.
- Palmstrom, A., 2001. Measurement and characterization of rock mass jointing. In: Sharma, V.M., Saxena, K.R. (Eds.), *In Situ Characterization of Rocks*. A.A. Balkema Publishers, pp. 49–97.
- Palmstrom, A., Blindheim, O.T., Broch, E., 2002. The Q system – possibilities and limitations. (in Norwegian) *Norwegian annual tunnelling conference on Fjellsprengningsteknikk/Bergmekanikk/Geoteknikk*, Oslo, pp. 41.1–41.38.
- Sen, Z., Eissa, E.A., 1991. Volumetric rock quality designation. *Journal of Geotechnical Engineering* 117 (9), 1331–1346.
- Serafim, J.L., Pereira, J.P., 1983. Consideration of the geomechanics classification of Bieniawski. *Proceedings of the International Symposium on Engineering Geology and Underground Constructions*, 1133–1144.
- Sonmez, H., Nefeslioglu, H.A., Gokceoglu, C., 2004. Determination of wJd on rock exposures including wide spaced joints. Technical note. *Rock Mechanics and Rock Engineering* 37 (5), 403–413.
- Terzaghi, K., 1946. Rock defects and loads on tunnel supports. In: Proctor, R.V., White, T.L., (Eds.), *Rock tunneling with steel supports*, vol. 1, 17–99. Commercial Shearing and Stamping Company, Youngstown, OH, pp. 5–153.
- Terzaghi, R., 1965. Sources of error in joint surveys. *Geotechnique* 15, 287–304.