

# STRUCTURAL GEOLOGY LABORATORY MANUAL

*Fourth Edition*

by David T. Allison  
Copyright © 2015

Associate Professor of Geology  
Department of Earth Sciences  
University of South Alabama

# TABLE OF CONTENTS

LABORATORY 1: Attitude Measurements and Fundamental Structures. . . . .	1-1
Reference system. . . . .	1-1
Attitude of Planes.. . . . .	1-2
Attitude of Lines. . . . .	1-5
The Pocket Transit. . . . .	1-6
Magnetic Declination.. . . . .	1-6
Measurement of Planar Attitudes with the Pocket Transit. . . . .	1-7
Measurement of Linear Attitudes with the Pocket Transit. . . . .	1-7
Locating Points with a Pocket Transit. . . . .	1-8
EXERCISE 1A: Geological Attitudes and 3D Block Diagram Interpretation.. . . . .	1-19
EXERCISE 1B: Geological Attitudes and 3D Block Diagram Interpretation.. . . . .	1-28
LABORATORY 2: Orthographic Projections for Solving True/Apparent Dips and Three-Point Problems. . . . .	2-1
True and Apparent Dip Calculations. . . . .	2-1
Three Point Problems.. . . . .	2-2
EXERCISE 2A: Orthographic Projections.. . . . .	2-7
EXERCISE 2B: Orthographic Projections.. . . . .	2-9
LABORATORY 3: Basic Stereographic Projections. . . . .	3-1
Stereographic Projections. . . . .	3-1
Elements of the Stereonet. . . . .	3-1
Plotting Planes and Lines on the Stereonet. . . . .	3-2
Solving Problems with the Stereonet.. . . . .	3-2
EXERCISE 3A: Stereographic Projections I. . . . .	3-7
EXERCISE 3B: Stereographic Projections I. . . . .	3-9
LABORATORY 4: Rotational Problems with the Stereonet.. . . . .	4-1
Plotting the Pole to a Plane. . . . .	4-1
Fold Geometry Elements. . . . .	4-1
Finding Paleocurrent Direction from Crossbed Data.. . . . .	4-2
Rotational fault problems.. . . . .	4-10
EXERCISE 4A: Rotations with the Stereonet.. . . . .	4-19
EXERCISE 4B: Rotations with the Stereonet.. . . . .	4-21
LABORATORY 5: Contoured Stereographic Diagrams.. . . . .	5-1
Types of Stereonets. . . . .	5-1
Constructing contoured stereonet.. . . . .	5-1
Interpretation of Stereograms.. . . . .	5-3

Analysis of Folding with Stereograms.....	5-4
Problems Associated with Fold Analysis on the Stereonet.....	5-5
EXERCISE 5A: Contoured Stereograms and Interpretation of Folded Data.....	5-6
EXERCISE 5B: Contoured Stereograms and Interpretation of Folded Data.....	5-9
LABORATORY 6: Campus Geologic Mapping Project.....	6-1
Mesoscopic Structure.....	6-1
Megascopic Structure Symbols.....	6-2
Pace and Compass Traverse.....	6-3
EXERCISE 6: Geologic Map and Structural Analysis General Instructions.....	6-5
EXERCISE 6A Geologic Map and Stereonet Analysis.....	6-6
EXERCISE 6B Geologic Map and Stereonet Analysis.....	6-8
LABORATORY 7: Geologic Map & Cross Section Field Project.....	7-1
EXERCISE 7A: High Fall Branch Geologic Map & Cross-Section.....	7-3
EXERCISE 7B: Tannehill Historical S.P. and Vicinity Geologic Map & Cross-section .....	7-6
LABORATORY 8: Thickness and Outcrop Width Problems.....	8-1
Thickness of Strata.....	8-1
Apparent thickness in a drill hole.....	8-4
EXERCISE 8A: Thickness and Outcrop Width Problems.....	8-5
EXERCISE 8B: Thickness and Outcrop Width Problems.....	8-6
LABORATORY 9: Outcrop Prediction.....	9-1
Outcrop Prediction.....	9-1
Special Cases.....	9-1
General Solution for Outcrop Prediction.....	9-2
EXERCISE 9A: Outcrop Prediction.....	9-7
EXERCISE 9B: Outcrop Prediction.....	9-9
LABORATORY 10: Stereographic Statistical Techniques.....	10-1
Least-squares Vector of Ramsay (1968).....	10-2
Least-squares Cylindrical Plane.....	10-2
Least-squares Conical Surface of Ramsay (1968).....	10-3
Goodness of Fit Measures.....	10-7
EXERCISE 10A: Stereograms and Statistical Techniques.....	10-10
EXERCISE 10B: Stereograms and Statistical Techniques.....	10-13
LABORATORY 11: Stress Analysis.....	11-1
Stress Field Ellipsoid.....	11-1
Mohr Circle Diagram.....	11-1

Constructing the Mohr Circle Graph. . . . .	11-3
Determining the Attitude of Stress Axes and Fracture Planes. . . . .	11-3
Mathematical Basis for Mohr Circle. . . . .	11-4
EXERCISE 11A: Mohr Circle and Stress Calculations. . . . .	11-6
EXERCISE 11B: Mohr Circle and Stress Calculations. . . . .	11-7
LABORATORY 12: Strain Analysis. . . . .	12-1
Strain Analysis. . . . .	12-1
Use of the Hyperbolic Net (De Paor's Method). . . . .	12-2
Plotting the Attitude of the Finite Strain Ellipse. . . . .	12-3
Solving for the Dimensions of the Finite Strain Ellipse. . . . .	12-4
EXERCISE 12A: Strain Analysis. . . . .	12-7
EXERCISE 12B: Strain Analysis. . . . .	12-9
LABORATORY 13: Fault Displacement Vectors. . . . .	13-1
Introduction to <i>Fault Translation</i> . . . . .	13-1
Apparent Translation ( <i>Separation</i> ). . . . .	13-1
Net Slip. . . . .	13-2
Rotational Faults. . . . .	13-2
. . . . .	13-5
EXERCISE 13: Fault Solutions. . . . .	13-5
. . . . .	13-5
LABORATORY 14: Down-plunge Fold Projections. . . . .	14-1
Introduction. . . . .	14-1
Constructing the Down-Plunge Profile Plane. . . . .	14-1
EXERCISE 14: Fold Projection. . . . .	14-5
LABORATORY 15: Constructing Geologic Cross-sections from Geologic Maps. . . . .	15-1
Exercise 15A: Geologic Cross-Sections. . . . .	15-5

## LIST OF FIGURES

<b>Figure 1-1</b> : Geologic time scale.....	1-9
<b>Figure 1-2</b> :Rule of “V”s for contacts..	1-10
<b>Figure 1-3</b> : Steeply dipping strata.....	1-10
<b>Figure 1-4</b> : Moderately dipping strata.....	1-11
<b>Figure 1-5</b> : Vertical strata.....	1-11
<b>Figure 1-6</b> : Overturned strata..	1-12
<b>Figure 1-7</b> : Apparent and true dips in a block diagram.....	1-13
<b>Figure 1-8</b> : Example anticline/syncline pair.....	1-13
<b>Figure 1-9</b> : Example of an unconformity..	1-15
<b>Figure 1-10</b> : example of a geological basin- younger strata in core with circular geometry contacts.....	1-15
<b>Figure 1-11</b> : Example of a plunging anticline/syncline pair.....	1-16
<b>Figure 1-12</b> : Example of a non-plunging overturned anticline/syncline pair.....	1-17
<b>Figure 1-13</b> : Example of a left-lateral strike slip fault..	1-17
<b>Figure 1-14</b> : Example of a reverse dip-slip fault..	1-18
<b>Figure 1-15</b> : Example of an oblique slip fault..	1-18
<b>Figure 1-16</b> : Diagram for problem 1A-1.....	1-21
<b>Figure 1-17</b> : Diagram for problem 1A-2.....	1-21
<b>Figure 1-18</b> : Diagram for problem 1A-3.....	1-22
<b>Figure 1-19</b> : Diagram for problem 1A-4.....	1-23
<b>Figure 1-20</b> : Diagram for problem 1A-5.....	1-23
<b>Figure 1-21</b> : Diagram for problem 1A-6.....	1-24
<b>Figure 1-22</b> : Diagram for problem 1A-7.....	1-24
<b>Figure 1-23</b> : Diagram for problem 1A-8.....	1-25
<b>Figure 1-24</b> : Diagram for problem 1A-9.....	1-25
<b>Figure 1-25</b> : Diagram for problem 1A-10.....	1-26
<b>Figure 1-26</b> : Diagram for problem 1A-11.....	1-26
<b>Figure 1-27</b> : Diagram for problem 1A-12.....	1-27
<b>Figure 1-28</b> : Figure for problem 1B-1.....	1-30
<b>Figure 1-29</b> : Diagram for problem 1B-2.....	1-30
<b>Figure 1-30</b> : Diagram for problem 1B-3.....	1-31
<b>Figure 1-31</b> : Diagram for problem 1B-4.....	1-31
<b>Figure 1-32</b> : Diagram for problem 1B-5.....	1-32
<b>Figure 1-33</b> : Diagram for problem 1B-6.....	1-32
<b>Figure 1-34</b> : Diagram for problem 1B-7.....	1-33
<b>Figure 1-35</b> : Diagram for problem 1B-8.....	1-33
<b>Figure 1-36</b> : Diagram for problem 1B-9.....	1-34
<b>Figure 1-37</b> : Diagram for problem 1B-10.....	1-34
<b>Figure 1-38</b> : Diagram for problem 1B-11.....	1-35
<b>Figure 1-39</b> : Diagram for problem 1B-12.....	1-35
<b>Figure 2-1</b> : Example problem 1 solution in spreadsheet form.....	2-2

<b>Figure 2-2</b> : Example problem 2 solution in spreadsheet form..	2-2
<b>Figure 2-3</b> : Diagram of a three-point problem solution.....	2-3
<b>Figure 2-4</b> : 3-point problem example in a spreadsheet.....	2-5
<b>Figure 2-5</b> : Spreadsheet for intersecting planes problem.....	2-5
<b>Figure 2-6</b> : Map for problem 5.....	2-8
<b>Figure 2-7</b> : Topographic map of the USA campus with 3 contact points A, B, and C.....	2-10
<b>Figure 2-8</b> : Geologic map of a portion of the Dromedary Quadrangle, Utah.....	2-11
<b>Figure 3-1</b> : Example apparent dip problem worked with NETPROG.....	3-4
<b>Figure 3-2</b> : Example Strike and Dip Problem worked in NETPROG.....	3-5
<b>Figure 3-3</b> : Example intersecting planes problem.....	3-6
<b>Figure 3-4</b> : Equal-area (Schmidt) stereographic lower-hemisphere projection.....	3-11
<b>Figure 4-1</b> : Example crossbedding paleocurrent problem.....	4-4
<b>Figure 4-2</b> : Crossbed example 1 rotation with Excel “rotation.xlsm”.....	4-5
<b>Figure 4-3</b> : Crossbed example 2 rotation with Excel “rotation.xlsm”.....	4-6
<b>Figure 4-4</b> : Example unfolding fold problem.....	4-9
<b>Figure 4-5</b> : Rotational fault example.....	4-13
<b>Figure 4-6</b> : Example rotational fault problem solution using “rotation.xlsm”.....	4-14
<b>Figure 4-7</b> : Alternative manual rotational fault example.....	4-15
<b>Figure 4-8</b> : Example Drill Core problem.....	4-16
<b>Figure 4-9</b> : Example drill core problem stereonet.....	4-17
<b>Figure 5-1</b> : Map for problem 2B.....	5-11
<b>Figure 5-2</b> : Counting net (equal area).....	5-12
<b>Figure 8-1</b> : Relationship of outcrop width ( $w$ ) to stratigraphic thickness ( $t$ ).....	8-1
<b>Figure 8-2</b> : Relationship between apparent ( $w'$ ) and true ( $w$ ) outcrop width.....	8-1
<b>Figure 8-3</b> : Cross-section of thickness with slope problem.....	8-2
<b>Figure 8-4</b> : Scenario where dip and slope directions are the same for thickness calculation. .....	8-3
<b>Figure 8-5</b> : Cross-section of depth problem.....	8-4
<b>Figure 9-1</b> : Example of horizontal contacts exposed in a valley.....	9-1
<b>Figure 9-2</b> : Example of geologic Rule of “V’s”.....	9-2
<b>Figure 9-3</b> : Initial setup of outcrop prediction example problem.....	9-5
<b>Figure 9-4</b> : Final solution of example outcrop prediction problem.....	9-6
<b>Figure 9-5</b> : Topographic map for problem 1.....	9-10
<b>Figure 9-6</b> : Topographic map for problem 2.....	9-11
<b>Figure 9-7</b> : Topographic map for problems 3 and 4.....	9-12
<b>Figure 9-8</b> : USA campus topographic map.....	9-13
<b>Figure 10-1</b> : Examples of eigenvector axial lengths.....	10-5
<b>Figure 10-2</b> : Example of data set that is normally distributed about a least-squares cylindrical surface according to the chi-square statistic.....	10-9
<b>Figure 11-1</b> : Example of the Mohr stress circle with fracture envelop.....	11-2
<b>Figure 11-2</b> : Actual physical test specimen for Mohr circle example.....	11-3
<b>Figure 12-1</b> : Simple shear of initially random ellipsoidal pebbles to form a preferred orientation of strain ellipsoids.....	12-1

**Figure 12-2** : Plot of strain axes and foliation.. . . . . 12-3

**Figure 12-3** : Undeformed and deformed strain marker reference used for derivation of formulae.  
. . . . . 12-5

**Figure 12-4** : Scanned photograph of deformed ooids in limestone.. . . . . 12-10

**Figure 12-5** : Tracing of the deformed ooids in Figure 12-4. Use this to calculate  $R_F$  and  $\Phi$ .  
. . . . . 12-11

**Figure 12-6** : Tracing of deformed pebbles in Cheaha Quartzite. Two parallel faces of the same  
sample (CA-23) are displayed... . . . . 12-13

**Figure 12-7** : Hyperbolic stereonet... . . . . 12-14

**Figure 12-8** : Photograph of deformed pebbles in a metaconglomerate with the cleavage  
direction indicated... . . . . 12-15

**Figure 13-1** : Example of traces of rotated dikes A and B... . . . . 13-3

**Figure 13-2** : Calculation of rotational axis position... . . . . 13-4

**Figure 13-3** : Map for problem 2.. . . . . 13-6

**Figure 13-4** : Map for problem 3.. . . . . 13-7

**Figure 14-1** : Down-plunge projection construction.. . . . . 14-4

**Figure 14-2** : Map for problem 1 projection.  
. . . . . 14-6

**Figure 15-1** : Example of apparent dip calculation for a vertical cross-section... . . . . 15-2

**Figure 15-2** : Example of the geometry of plunging folds and cross-section.. . . . . 15-3

**Figure 15-3** : Geologic Map of the Wyndale and Holston Valley Quadrangles, VA... . . . . 15-6

**Figure 15-4** : Geologic cross-sections of the Wyndale and Holston Valley Quadrangles, VA.  
. . . . . 15-7

## LABORATORY 1: Attitude Measurements and Fundamental Structures.

### I. Reference system

- (A) Geological structures are represented by one or more lines or planes.
- (B) A line can be defined in three-dimensional space by its angle with three orthogonal axes. A plane can be represented by its normal, which itself is a line.
- (C) Maps contain two horizontal references: *Latitude* and *Longitude* (N-S, E-W)
- (D) The third reference axis is a vertical line.
- (E) Geologists typically orient structures with reference to the horizontal (strike, bearing, trace, trend) and the vertical (dip, plunge, inclination).
- (F) Specifying the orientation or *attitude* relative to the horizontal and vertical references will specify completely the three-dimensional orientation of a line or plane.
- (G) Orientation within the horizontal reference plane (map) is read relative to a compass direction (north, south, east, west) in units of degrees.
- (H) Orientation relative to the vertical is described simply as the angle measured from the horizontal plane to the plane or line of interest, this measurement being made in a vertical plane. This angle ranges from 0 to 90°.

### II. Important Geometrical Terms

- (A) *Apparent dip*: dip (incline) of a plane in a vertical plane that is not perpendicular to the strike. The apparent dip is always less than the true dip.
- (B) *Attitude*: orientation of a geometric element in space.
- (C) *Azimuth*: a compass direction measured in degrees clockwise from north with north=0, east=90, south=180, and west=270.
- (D) *Bearing*: the compass direction of a line, in quadrant format.
- (E) *Cross section*: representation of a geometry on a plane perpendicular to the earth's surface.
- (F) *True dip*: the inclination of a plane measured in a vertical plane trending perpendicular to strike.

(G) *Dip direction*: trend of the dip line; always perpendicular to strike.

(H) *Inclination*: angle that the trace of a geometric element (line or plane) makes with the horizontal measured in a vertical plane. The maximum angle is 90 degrees (vertical). The angle of inclination of a plane is termed dip, for a line it is referred to as the plunge.

(H) *Lineation*: general term for a geological feature that is best represented by a line (mineral lineation, stretched pebbles, fold hinge, etc.)

(I) *Pitch*: the angle between a line and the strike of the plane that contains the line. Pitch is synonymous with rake.

(J) *Plunge*: angle of inclination of a line measured in a vertical plane.

(K) *Plunge direction*: trend of a plunging line.

(L) *Quadrant*: a compass direction measured 0-90 degrees from north or south. An example would be N60W (=300 azimuth) or S30E (= 150 azimuth).

(M) *Rake*: angle measured between a line and the strike of the plane that contains the line. The quadrant of the end of the strike line from which the measurement is made must be included as part of the rake angle unless the rake angle = 90 (i.e. 40NE for a 40 degree rake angle measured from the northeast end of the strike).

(N) *Strike*: the trend (compass direction) of the horizontal line in a geological plane (i.e. bedding, fault, joint, axial plane, etc.). By convention the compass direction of the strike is always assigned to a north quadrant., therefore, the azimuth possibilities are 0-90 and 270-360. Note that 360 azimuth is the same strike as 0.

(O) *Trace*: the line formed by the intersection of two non-parallel surfaces.

(P) *Trend*: azimuth direction of a line in map view.

## II. Attitude of Planes

(A) Bedding, cleavage, foliation, joints, faults, axial plane are some of the geological structures that are represented as a plane. Although some of these features are actually *curvilinear* (i.e. curved surfaces), over short distances their tangent surfaces can be considered planar.

(B) The linear attitude component of a plane that is measured in the horizontal reference plane is termed the *strike*. The strike of a plane is defined as the compass direction formed by the intersection of that plane with a horizontal reference plane. Another way to

define strike is simply as **the compass direction of the horizontal line contained in the geological plane of interest**. By convention the azimuth direction of a strike line is read to a north quadrant so allowable measures of strike azimuth are in the range "000-090" and "270-360" for strike azimuth, or (N0E - N90E) and (N0W-N90W) for quadrant format strike line bearing.

The only situation where the above definitions are ambiguous would be the special case where the plane of interest is horizontal, in which case there are an infinite number of horizontal lines in the plane. In this special case the strike is "undefined", and a geologist would describe the plane as "horizontal" or has a "dip = 0".

(C) The orientation of the strike line relative to the compass direction can be recorded in one of two ways:

1. *Quadrant* - N45°E, N15°W, N90°E (always read to a north quadrant)
2. *Azimuth*- 033°, 280°, 090° (always read to a north quadrant)

Note that since there are two possible "ends" to a strike line, by convention strike lines are measured in the northern quadrants.

(D) If you are using azimuth convention, be sure to use three digits even if the first one or two digits are "0". This avoids confusion with plunge or dip.

(E) The *dip* of a plane defines its attitude relative to the vertical reference. There are two types of dip values:

1. *True dip*- all planes have only one unique value for true dip
2. *Apparent dip*- all planes have many possible apparent dip values that range from zero to less than, but not equal to, the true dip value.

(F) The *dip angle* is the angle measured in a vertical plane from the horizontal down to the plane of interest. The true dip is always measured in the vertical plane that trends perpendicular to the strike of the plane. A dip angle measured in a vertical plane trending in any other map direction will always yield an apparent dip value less than that of the true dip. An apparent dip measured parallel to strike always will yield a dip angle of 0°.

(G) Dip values always are in the range 0-90°. A dip angle of 0° defines a horizontal attitude. 90° of dip describes a vertically oriented plane.

- 0-20°: Shallow
- 20-50°: Moderate
- 50-90°: Steep

(H) Specification of the strike orientation and dip angular value does not indicate the three-dimensional orientation of a plane; the direction of the dip inclination must also be known:

Possible Strike/Dip quadrant combinations.		
	Northeast Strike (0-090 azimuth)	Northwest Strike (270-360 azimuth)
True dip trends east	SE	NE
True dip trends west	NW	SW

(I) Note that it is unnecessary to measure the exact compass direction of the dip direction since it is by definition 90° from the strike. A full strike and dip might be recorded as:

N45°E, 30°SE (quadrant strike first, then dip and dip direction)  
 045°, 30°SE (Strike azimuth first, then dip and dip direction)

(J) Several different map symbols have been agreed upon by geologists to represent specific planar structures on geologic maps. All of the symbols have these characteristics in common:

1. The long dimension of the symbol is parallel to the strike line.
2. A tic mark or arrow oriented perpendicular to strike will point in the dip direction. A number next to this part of the symbol is the value of the true dip.
3. Special symbols exist for horizontal and vertical attitudes.

(K) Because a geologic map must sometimes show multiple generations of planar structures, geologists must often "invent" symbols for a specific map. One should always explain the meaning of all symbols used within the map legend.

(L) Besides strike and dip several alternative methods have been used to define a 3D planar attitude:

1. *Right-hand rule*: the azimuth direction of the strike is recorded such that the true dip is inclined to the right of the observer. In this case the strike azimuth could be to any quadrant. For example, the traditional strike and dip of 320, 55SW would be recorded as 140, 55.
2. *Dip azimuth and Dip angle*: this method relies on the implicit 90° angle between the true dip azimuth and the strike. The observer measures the dip azimuth and then the true dip angle. For example, a traditional strike and dip of

320, 55SW would instead be 050, 55.

### III. Attitude of Lines

(A) Many geological structures such as fold hinges, mineral lineation, igneous flow lineation, intersection lineation, fault striations, flute casts, etc., possess a linear geometry in three-dimensional space.

(B) Strike and dip cannot be used to measure the attitude of a line. *Bearing* and *Plunge* are the two components of linear attitude.

(C) The plunge of a line is the angle that the line makes with the horizontal reference measured in a vertical plane. The plunge angle ranges from 0-90°.

(D) The projection of the linear feature directly to the horizontal reference plane forms a line that is the bearing of the linear element. The bearing, like the strike, is measured relative to the compass direction. In this course we will normally use azimuth rather than compass quadrants to indicate bearing direction.

(E) Although the bearing is measured in the same horizontal reference plane as the strike, its trend may be to any quadrant of the compass. This is because the bearing of the linear feature describes the compass direction of the plunge inclination, which could be in any direction.

(F) To clearly distinguish it from a strike and dip, a linear attitude may be written as a plunge and bearing with the plunge angle first:

55°, 145° (plunge angle first, then the bearing azimuth)

Although this convention is not universally followed.

(G) A plunge angle value of 0° describes a horizontal line. A plunge angle of 90° denotes a vertical line, in which case the bearing is undefined since it has no component parallel to the horizontal reference.

(H) Another term may be used to describe the attitude of a line if the line lies within a plane of known strike and dip. This value is the *rake* or *pitch* angle, and it is defined as the angle made by the line with the strike line of the plane in which it is contained. The direction end of the strike line from which the angle is measured must be noted to fix the attitude of the line.

(I) Linear elements are displayed on a geologic map with a variety of features. The long dimension of these symbols describes the trend with an arrow pointing in the plunge

compass direction. The numeric value next to the arrowhead is the plunge angle value in degrees.

(J) Since many lineations are intimately related to certain planar features, such as a metamorphic mineral lineation contained within a planar foliation, these two structural elements may be combined into a composite map symbol on geologic maps.

#### IV. The Pocket Transit (Brunton Compass)

(A) The traditional survey instrument of the geologist has been the *Brunton Compass* or *pocket transit*, although the *alidade* and *plane table* is used in studies where more accuracy is needed.

(B) The Brunton contains a magnetic needle that always seeks *true magnetic north*. On most, but not all, Bruntons, the white end of the needle points to magnetic north.

(C) The perimeter of the compass is divided into degrees based on one of two formats:

1. Quadrant- four quadrants (NE, SE, NW, SW) of 90° each.
2. Azimuth - 0 to 360°.

(D) A foldout metal pointer, termed the “sighting arm”, defines the long axis of the instrument. This is used as a sighting alignment for measuring a strike line or bearing.

(E) Inside the compass is a bull's eye level and a *clinometer* level. The round bull's eye levels the body of the compass within the horizontal plane. The clinometer can be used to measure angles within a vertical plane. With the ability to measure both compass direction from magnetic north and vertical angles with the clinometer, the pocket transit can determine strike and dip or plunge and bearing of any geological structure.

(F) Examination of either format compass reveals that the compass directions run in counterclockwise rather than clockwise fashion. This is done so that the north end of the needle reads the correct quadrant or azimuth value if one is sighting along the extended metal pointer arm.

#### V. Magnetic Declination

(A) Since magnetic north and geographic north do not coincide, geologic maps and survey instruments must correct for the angular difference in these values. In the United States, for example, the *magnetic declination* ranges from 0 to over 20°. The declination angle is measured as east or west depending on its orientation relative to geographic north.

(B) All *United State Geological Survey* (USGS) topographic maps have the magnetic declination indicated in the margin information. 7.5' USGS topographic maps are the standard mapping tools for geological mapping. GPS receivers typically provide an up-to-date measurement of the magnetic declination. USGS maps published more than several decades ago will have inaccurate declination value.

(C) To correct for magnetic declination, the pocket transit can be adjusted by turning the screw located on the side of the compass case. Turning this screw rotates the compass direction scale. Therefore, the compass can be adjusted for magnetic declination by ensuring that the long axis of the Brunton (sighting arm) points to geographic north when the north end of the needle indicates the  $0^\circ$  position. All USGS maps have the magnetic declination value for the map area printed on the bottom center margin of the map.

## VI. Measurement of Planar Attitudes with the Pocket Transit

(A) Direct measurement of strike.

(B) Direct measurement of dip.

(C) Use of notebook or compass plate to simulate attitude of plane.

(D) Shooting a strike and dip from a distance with peep sight.

(E) Dips less than  $12^\circ$  cannot be measured because of the clinometer ring protector.

1. Water will run directly down the true dip direction if dripped on a smooth planar surface.

2. Visually estimate the true dip direction. Measure the dip angle in several directions sub-parallel to this direction. The steepest dip is the true dip direction.

The strike is, of course, perpendicular to the true dip direction determined from the above methods.

(F) When measuring dip angles remember that the clinometer bubble must be up while the pocket transit is held against the planar structure.

## VII. Measurement of Linear Attitudes with the Pocket Transit

(A) The first component of a linear structure that is measured is usually the bearing. To measure the bearing one must line up the long axis of the compass parallel to the projection of the line to the horizontal. There are several methods that accomplish this:

1. Line the feature with the metal pointer while leveling the compass.
2. Align a clipboard or compass plate with vertical and parallel to the linear structure. Hold the compass against the plate while leveling.
3. Sight to a distant landmark that lies along the lineation using the peep hole sight.
4. Hold the compass against or close to the lineation. Level while keeping the edge of the compass parallel to the lineation. The azimuth read will be parallel to the structure.
5. Lineations observed on an overhanging surface can be almost impossible to measure directly. First measure the strike and dip of the surface that contains the lineation. With a protractor or compass measure the angle that the lineation makes with the strike line of the surface, carefully noting from which end of the strike line that the angle was measured. This is the *rake* angle of the lineation in the plane. In this case the strike and dip may not correspond to any geological structure— it is simply a reference plane. The plunge and bearing of the lineation may be calculated later with stereographic office methods (see Laboratory 2).

(B) After determining the bearing you must measure the plunge angle. To determine the plunge, arrange the compass edge parallel to the lineation while measuring the plunge angle with the clinometer. It may be necessary for a partner to hold a pencil parallel to the lineation for reference while you measure the plunge on that object.

(C) If the lineation lies within a planar structure whose attitude has already been recorded one may simply measure the rake angle of the lineation or bearing of the lineation (see section A-5 above). Either of these can later be converted to a bearing and plunge for plotting on a geologic map. The conversion can be done in the field with a stereonet.

(D) If the lineation has a steep plunge, it may be difficult to visualize the correct bearing. In this case, if the lineation lies within a plane it is more accurate to measure its rake angle with a protractor, after first measuring the strike and dip of the plane containing the linear element.

## VIII. Locating Points with a Pocket Transit

(A) The accuracy of a geologic map is totally dependent upon the accuracy of your field stations. The first job of the geologist is to accurately locate his or her position on the map. The compass can aid you in several ways.

(B) Pace and Compass: in areas where no suitable topographic map exists, or where

traverses do not follow existing roads or trails on the map, it is necessary to keep track of position with a pace and compass traverse. The traverse is done by estimating distance from point to point with pace counts, while bearings are shot from point to point and recorded. The traverse is later plotted on the map with a protractor and scale. The traverse must start from a known reference point.

(C) Triangulation can locate a position by the determination of the bearing to two or more known landmarks that occur on a map. Plotting the reverse azimuth of the landmarks will intersect at the current position on the map.

## IX. Geologic Time

(A) The geologic time scale must be understood for proper evaluation of geologic structures. Stratigraphic codes utilize the time scale to indicate the relative ages of strata. (Figure 1-1)

# Geologic Time

Young	Period	Symbol	Young	Period	Symbol
↓ Old	Quaternary	Q	↓ Old	Mississippian	M
	Tertiary	T		Devonian	D
	Cretaceous	K		Silurian	S
	Jurassic	J		Ordovician	O
	Triassic	Tr		Cambrian	-C
	Permian	P		Precambrian	p-C
	Pennsylvanian	P			

**Figure 1-1** : Geologic time scale.

(B) Stratigraphic codes such as “Oc” on a geologic map may mark the exposed area of the Ordovician age Chickamauga Formation. The geologic period abbreviation is always uppercase, whereas the formation name abbreviation is lowercase. Note the special symbols for Precambrian, Cambrian, Pennsylvanian, and Triassic.

## X. Rule of “V” for Geologic Contacts

(A) When inclined beds cross a stream valley the contact will form a “V” pointing in the dip direction. (**Figure 1-2**)

(B) The “V” shape is more pronounced with shallow dips, less so as the dip angle increases.

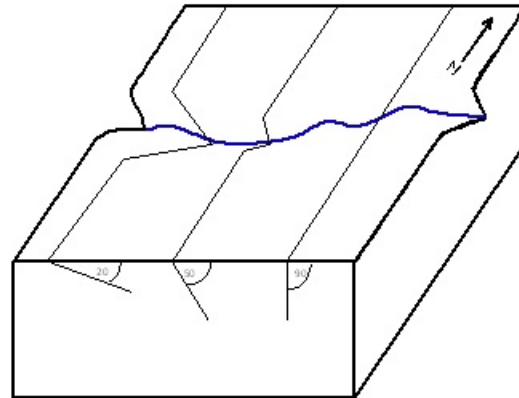
(C) If the contact is vertical (i.e. dip angle =90) the contact will not form a “V” when crossing a valley. Instead there is no offset therefore the contact remains straight in map view.

### Rule of “V’s” for Geologic Contacts Crossing Stream Valleys

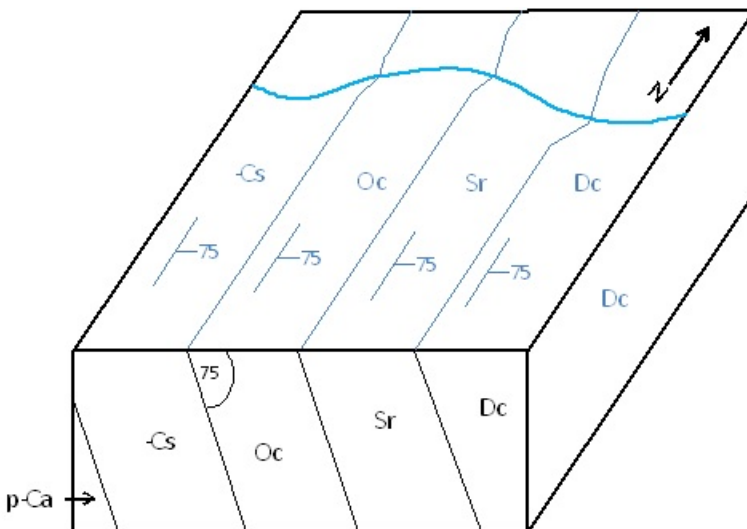
#### XI. Bedding Strike and Dip Symbols

(A) **Figures 1-3** through **1-6** illustrate various strike and dip symbols required for different attitudes of bedding.

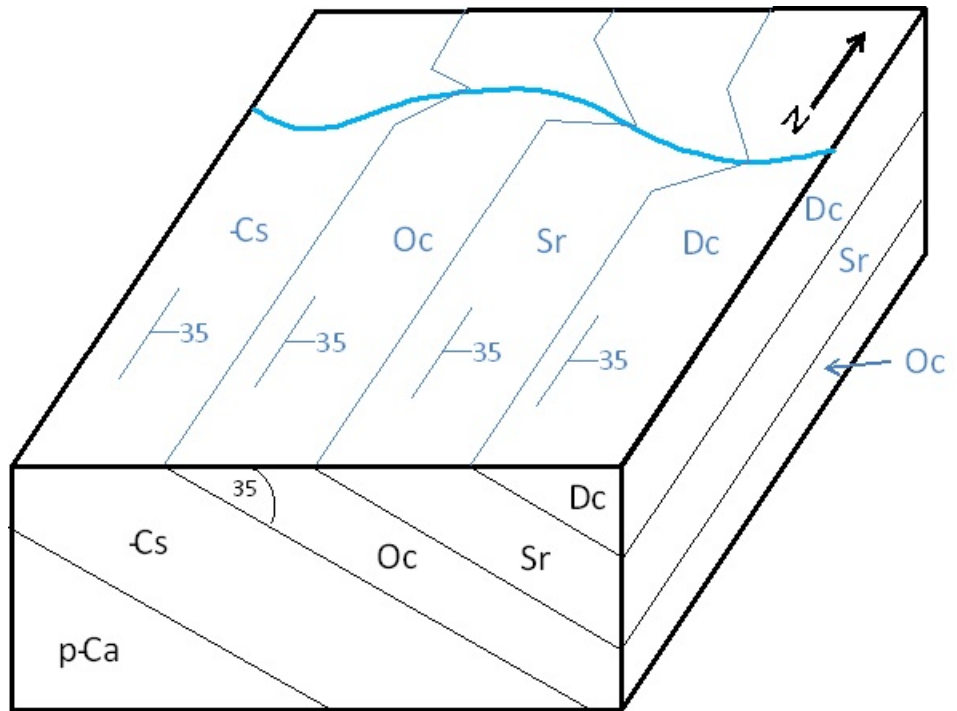
(B) Note that in the case of overturned bedding the strata would have to be rotated more than 90 degrees to return the stratigraphic section to its original horizontal position.



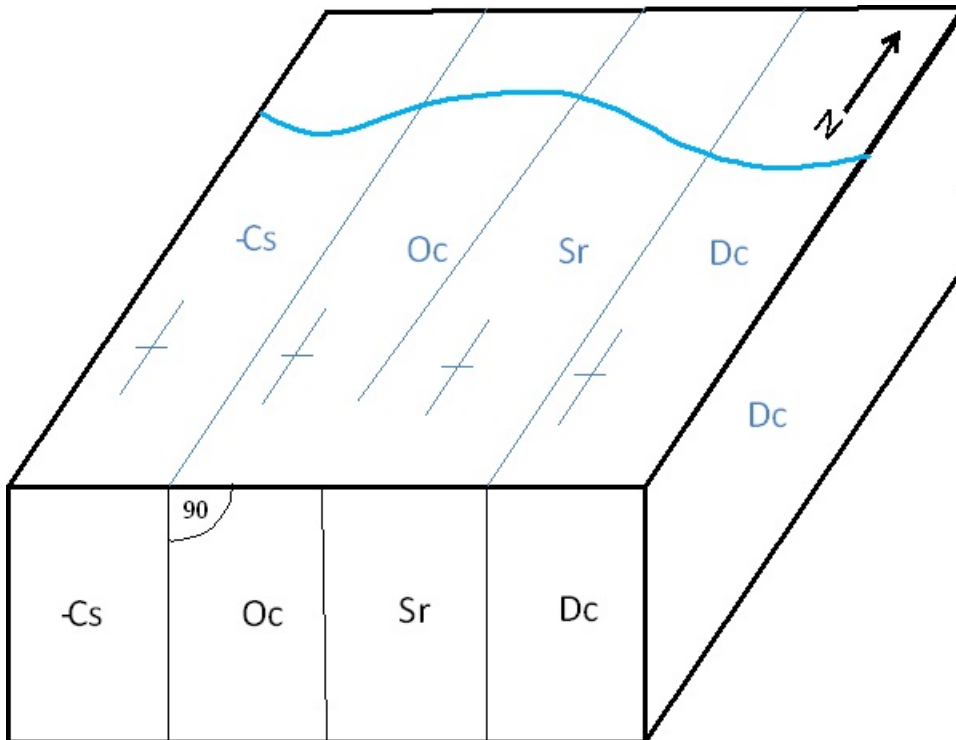
**Figure 1-2** :Rule of “V”s for contacts.



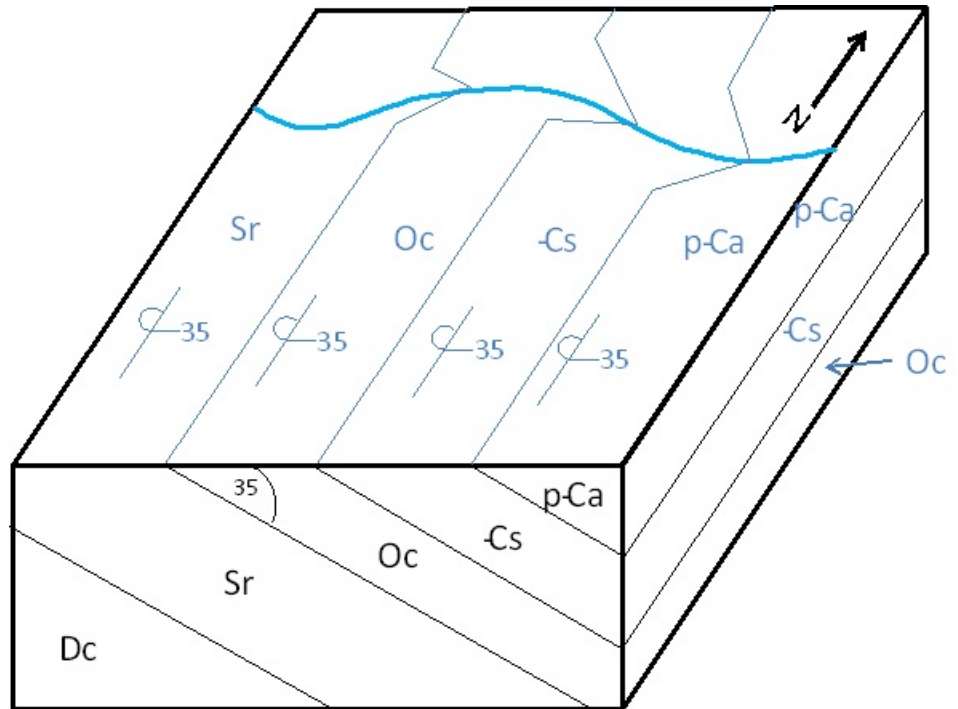
**Figure 1-3** : Steeply dipping strata.



**Figure 1-4** : Moderately dipping strata.



**Figure 1-5** : Vertical strata.

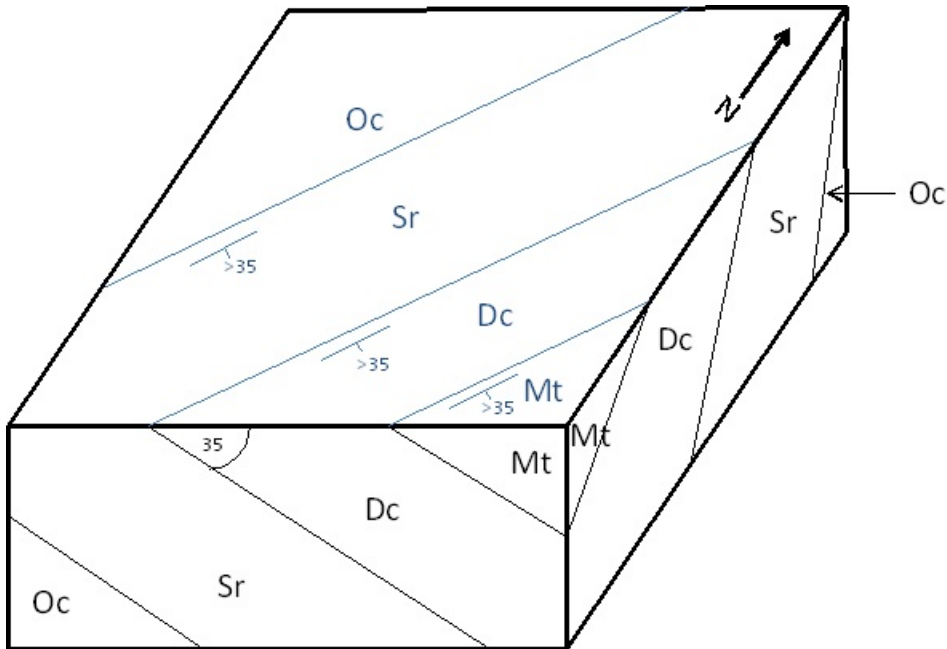


**Figure 1-6** : Overturned strata.

## XII. Apparent Dips and Block Diagrams

(A) If inclined stratigraphic contacts intersect the vertical sides of a 3D block diagram such that the trend of the vertical side is not perpendicular to the strike of the contact the inclined angle of the strata on the side view will be an apparent dip rather than the true dip. The apparent dip is always less than the angle of the true dip.

(B) In block diagrams apparent dips on the side view can constrain the true dip value used for the strike and dip symbol, as in **Figure 1-7**.



**Figure 1-7 :** Apparent and true dips in a block diagram.

### XIII. Non-Plunging Folds and 3D Block Diagrams

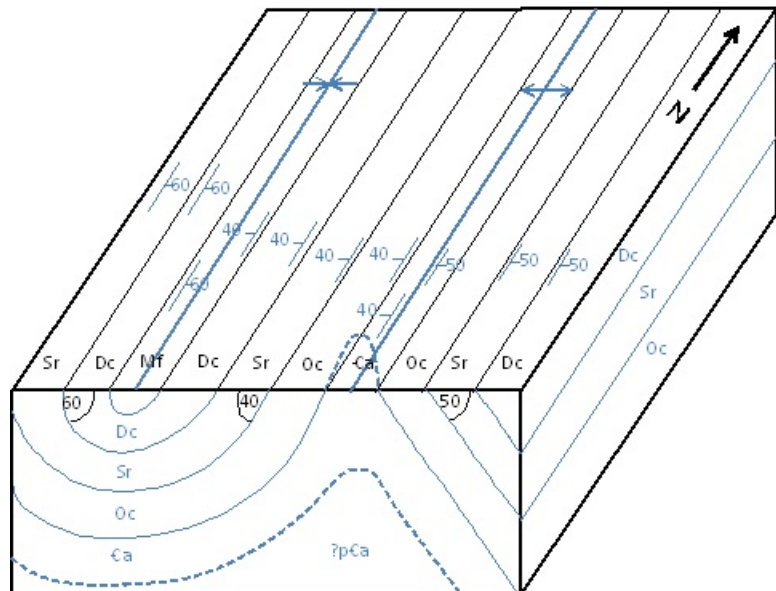
(A) Fold structures are most effectively displayed on 3D Block diagrams because they display the interpretation of the structure in the subsurface. (**Figure 1-8**)

(B) Remember to use as much information from the map as possible - for example even though a contact does not intersect a vertical face on the block, it is possible that a contact may project to the face in the subsurface.

© Anticlinal and synclinal closures should be used whenever possible. If a fold hinge projects above the diagram “in the air” it should be dashed.

(D) Use stratigraphic info- if the map surface displays a thickness for a unit make sure that is displayed on the vertical faces of the diagram.

(E) The anticline axial trace symbol indicates that both



**Figure 1-8 :** Example anticline/syncline pair.

limbs of the fold dip away from the core; syncline symbol indicates limbs dip toward the core of the fold structure.

(F) Anticlines always contain the older strata in the core of the structure. Synclines contain the younger strata in the core of the structure.

(G) If a fold structure is concave-down in cross-sectional profile but contains the younger strata in the core it is termed a *antiformal syncline*.

(H) If a fold structure is concave-up in cross-sectional profile but contains the older strata in the core it is termed a *synformal anticline*.

(I) A concave-down structure with strata of indeterminate age relationships is termed an *antiform*. A concave-up structure is a *synform*.

(J) The *fold limb* of a fold is considered to be the portion of a fold between adjacent fold hinges. For example, in **Figure 1-8** the area between the synclinal and anticlinal trace is a single limb. This limb is shared between the adjacent folds marked by the axial traces on the map. There are 3 limbs displayed in **Figure 1-8** on the map view or front-face view of the diagram.

(K) Note that the strike directions of the strike and dip symbols in **Figure 1-8** parallel the geological contacts, and those contacts are straight lines.

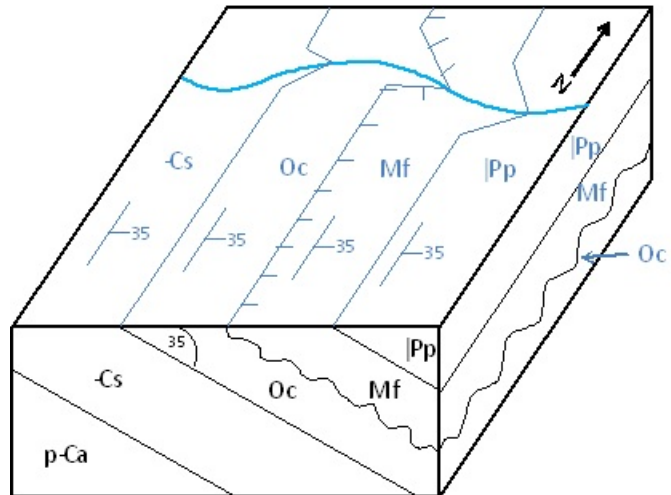
(L) In the map view a non-plunging fold will have straight, parallel contact lines between stratigraphic units. The only curved contact lines will be along the vertical sides of the block diagram (**Figure 1-8**).

#### XIV. Unconformable Contacts

(A) Unconformable contacts are produced by geologically significant intervals of time marked by uplift and erosion, or by non-deposition. On geologic maps and/or cross sections these contacts are recognized by discontinuity in the geologic time scale. For example, if the upper stratigraphic contact of a Cambrian formation was also the lower stratigraphic contact of a Devonian formation the contact must be some type of unconformity.

(B) In map view an unconformity (*angular unconformity, disconformity, nonconformity*) is symbolized by placing hachure tic marks on the young side of the contact. (**Figure 1-9**)

© In cross-section view, or along the vertical sides of a 3D block diagram *unconformable* contacts should be a undulating “squiggly” line indicating erosional relief.



**Figure 1-9** : Example of an unconformity.

### XV. Domes and Basins

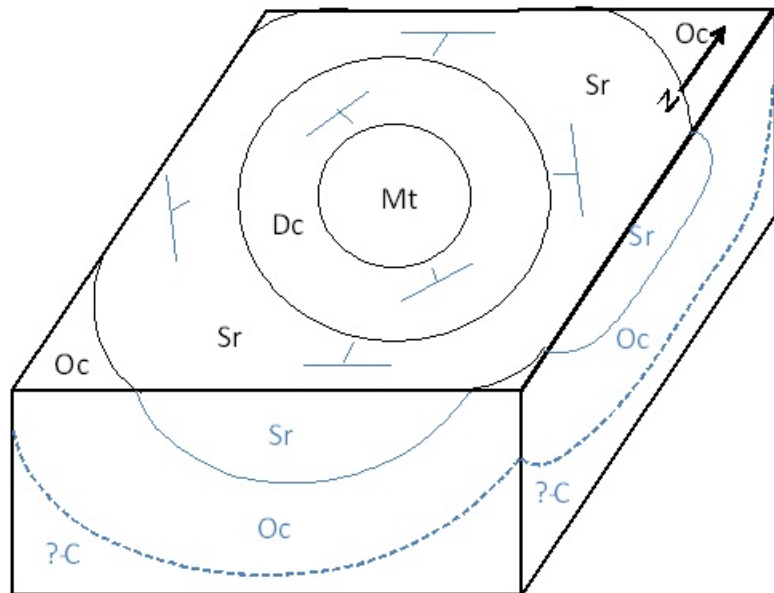
(A) Domes and basins are similar to anticlines and synclines respectively in that domes contain oldest strata in the core (center) of the structure, whereas basins contain younger strata in the core of the structure (**Figure 1-10**).

(B) Unless overturned strata are present strike and dip symbols dip away from the core of a *dome*, and dip toward the core of the structure for a geological *basin* (**Figure 1-10**).

© The contacts of a basin or dome are generally circular to elliptical in geometry forming a “bull’s-eye” type pattern of contacts (**Figure 1-10**).

(D) Note that geological basins and domes do not imply any type of topography. A geologic basin may in fact be a topographic “dome” and a geologic dome may in fact be a topographic basin.

(E) Note that the strike line directions of the strike and dip symbols in the map view are always tangent to the contacts in **Figure 1-10**.



**Figure 1-10** : example of a geological basin- younger strata in core with circular geometry contacts.

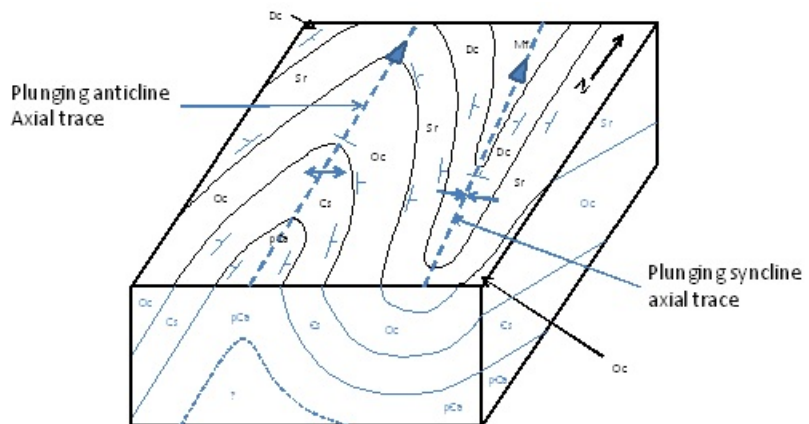
## XVI. Plunging Folds

(A) Plunging folds have the same relationships as non-plunging folds with the following exceptions (**Figure 1-11**):

1. Contacts in map view are curved rather than straight. (**Figure 1-11**)
2. The axial trace symbols have an arrow that points in the direction of the plunge of the hinge of the fold.
3. Strike and dip symbols are tangent to the curved contacts in map view.
4. Vertical sides of the block diagram parallel to axial traces of folds display contact lines inclined in the plunge direction. (**Figure 1-11**)

(B) For *plunging anticlines* the “V” made by curved contacts in map view points in the plunge direction.

© For *plunging synclines* the “V” made by curved contacts in map view points away from the plunge direction.



**Figure 1-11** : Example of a plunging anticline/syncline pair.

## XVI. Overturned Folds

(A) Overturned folds have one limb containing overturned strata- otherwise they follow the rules discussed above for anticlines and synclines.

(B) In an overturned fold both limbs dip in the same direction therefore the axial trace fold symbol is modified to indicate that fact. (See **Figure 1-12**).

© In the overturned limb the strike and dip symbols will be the special type indicating overturned strata. (**Figure 1-12**).

(D) Note that the overturned anticline and syncline symbols indicate that limbs dip in same direction with anticline symbol arrows pointed away from axial trace line, and the overturned syncline symbol having arrows pointed toward the axial trace line. (Figure 1-12)

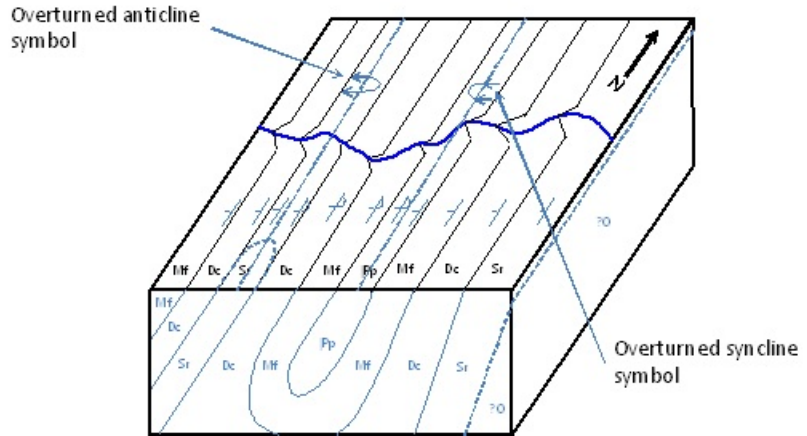


Figure 1-12 : Example of a non-plunging overturned anticline/syncline pair.

### XV. Fault Classification and Block Diagram Interpretation.

(A) Fault classification is based on the type of movement between the two structural blocks on opposite sides of the fault contact:

1. Slip parallel to strike of fault: *Strike-slip fault*.
2. Slip parallel to dip line of fault: *Dip-slip fault*.
3. Slip component parallel to both strike and dip lines: *Oblique-slip fault*.

#### (B) Strike Slip Fault Classification

1. If a contact that is offset by the fault is displaced to the right the fault is *right lateral*.
2. If a contact that is offset by the fault is displaced to the left the fault is *left lateral*.

(Figure 1-13).

3. On the front vertical face of the diagram the block that slips toward the observer is labeled with a “+” symbol

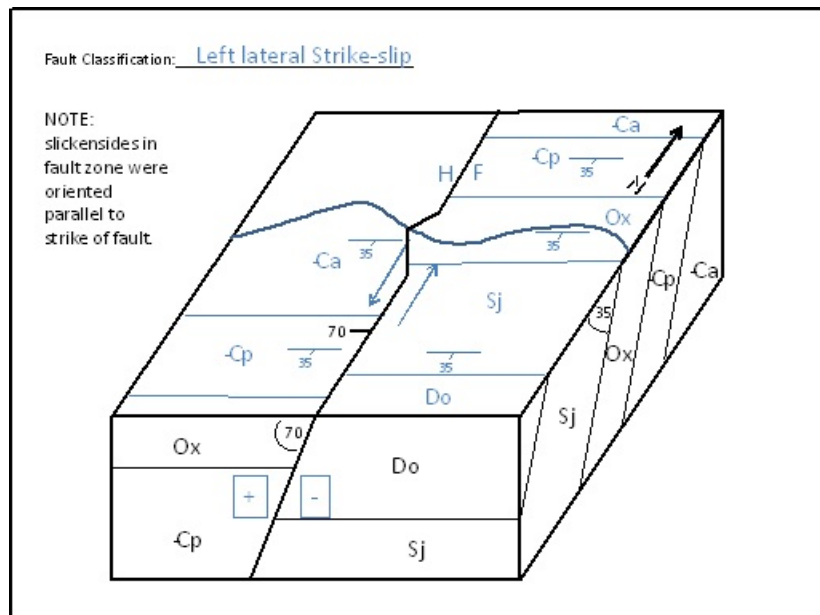


Figure 1-13 : Example of a left-lateral strike slip fault.

and a “-“ symbol for the block that slips away from the observer.

© Dip Slip Fault Classification

1. The *hanging wall* is always the block that contains the dip direction tic mark. The *footwall* is the other block.
2. Hanging wall down slip relative to the footwall is a *normal dip slip* fault.
3. Hanging wall up slip relative to the footwall is a *reverse dip slip* fault. (Figure 1-14)

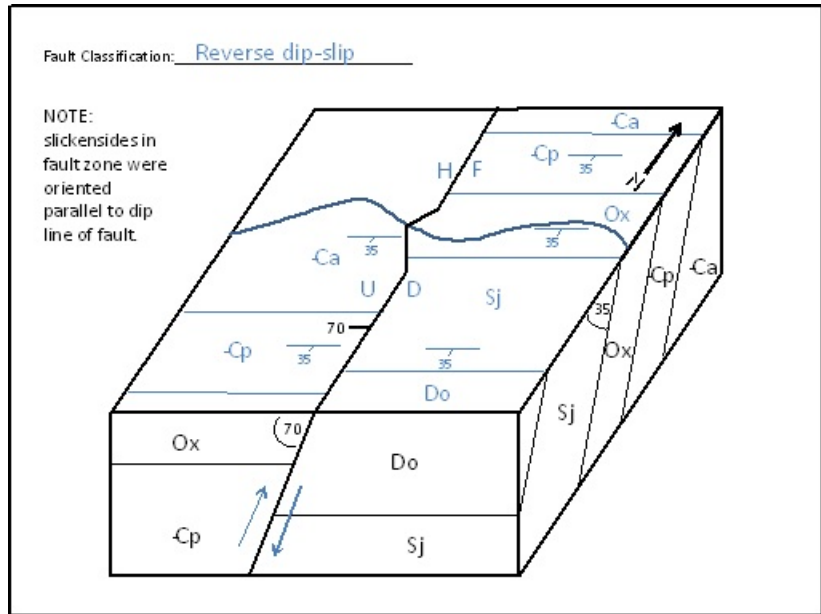


Figure 1-14 : Example of a reverse dip-slip fault.

(D) Oblique Slip Fault: oblique slip faults contain both a strike slip and dip slip component. If the relative magnitudes of the two components can be determined the larger is listed last when describing the fault. In Figure 1-15 the strike slip component was larger than the dip slip because in the description the right-lateral strike slip is listed last.

Fault Classification: Oblique: Normal dip-slip and rt-lat. Strike-slip

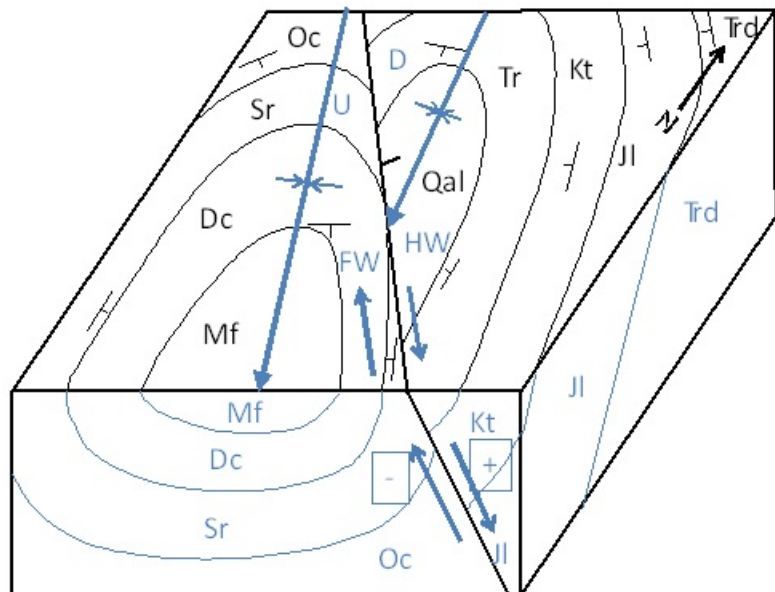


Figure 1-15 : Example of an oblique slip fault.

EXERCISE 1A: Geological Attitudes and 3D Block Diagram Interpretation

Problem 1A-1: Using **Figure 1-16** fill in the below matching items with the proper planar attitude. Use the “Strike azimuth, Dip angle and dip quadrant” format for your answer (ex. 045, 65 SE).

- (A) \_\_\_\_\_ (B) \_\_\_\_\_ (C) \_\_\_\_\_  
(D) \_\_\_\_\_ (E) \_\_\_\_\_ (F) \_\_\_\_\_  
(G) \_\_\_\_\_ (H) \_\_\_\_\_ (I) \_\_\_\_\_

Problem 1A-2: Given the below planar attitudes fill in the **Figure 1-17** diagram with the proper bedding symbol. Note that the below planar formats vary:

- (A) 090, 34 S (B) N60E, 12 SE (C) 330, 05NE  
(D) 060, 07NW (E) Rt. Hand: 210, 35 (F) N30E, 90  
(G) Dip trend & angle: 270, 45 (H) 000, 07 W OT (I) horz. (Dip=0)

Problem 1A-3: Given the below linear attitudes fill in the **Figure 1-18** diagram with the proper lineation symbol. Note that the below linear formats vary:

- (A) 210, 15 (B) 330, 05 (C) 65, 060  
(D) 120, 40 (E) 030, 00 (F) 000, 90  
(G) 23, S60W (H) 72, N60W (I) 150, 55

Problem 1A-4: Using the block diagram in **Figure 1-19** add relevant information to the map surface portion of the block diagram. Include strike and dip symbols in each stratigraphic unit on the map surface. Label each stratigraphic unit with the proper abbreviation.

Problem 1A-5: Complete the block diagram in **Figure 1-20**. Complete all visible sides to the block diagram, and add strike and dip symbols, abbreviations, and fold axial trace symbols to the map surface.

Problem 1A-6: Complete the block diagram in **Figure 1-21**. Complete all visible sides to the block diagram, and add strike and dip symbols, abbreviations, and fold axial trace symbols to the map surface. Note the stream on the map surface.

Problem 1A-7: Complete the block diagram in **Figure 1-22**. Complete all visible sides to the block diagram, and add strike and dip symbols to the map surface. Note the stream on the map surface.

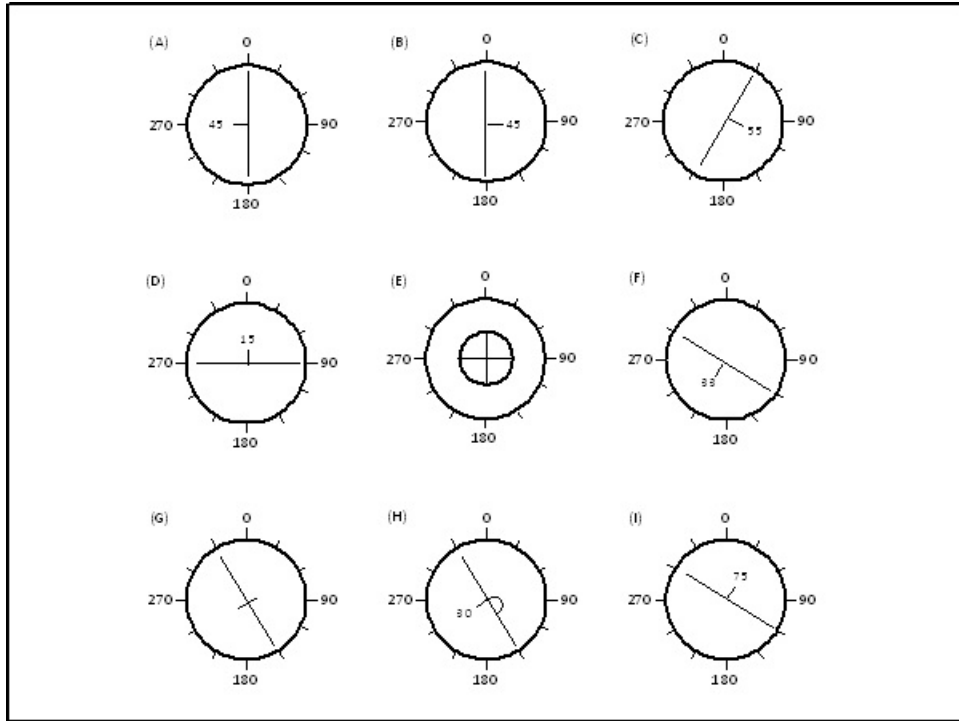
Problem 1A-8: Complete the block diagram in **Figure 1-23**. Add strike and dip symbols, unit abbreviations, and fold axial trace symbols to the map surface. Note the stream on the map surface.

Problem 1A-9: Complete the block diagram in **Figure 1-24**. Complete all visible sides to the block diagram, and add strike and dip symbols and fold axial trace symbols to the map surface.

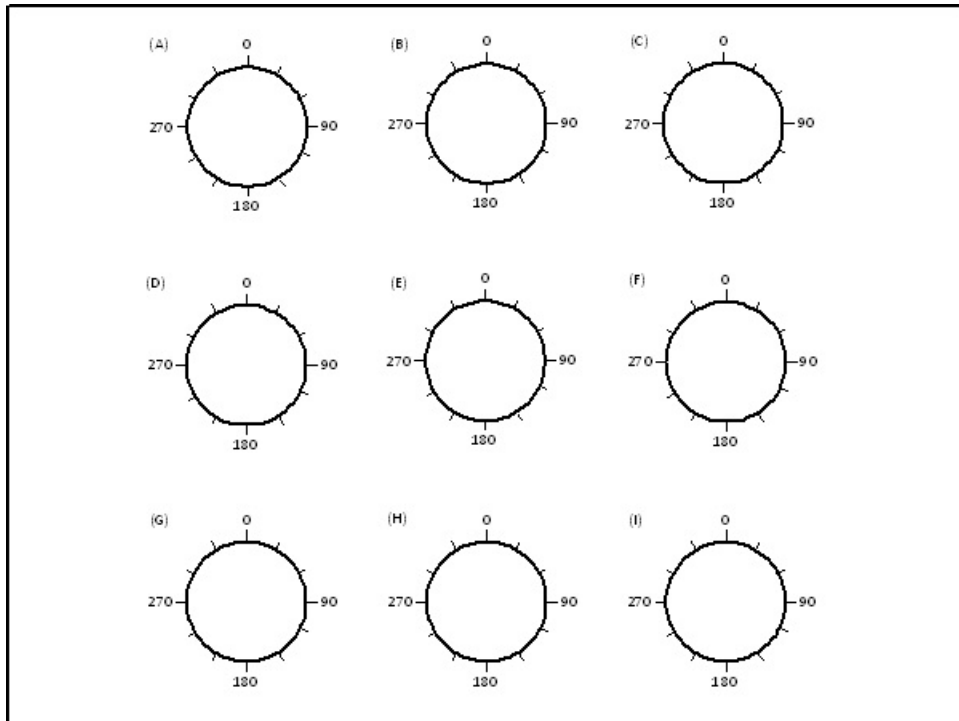
Problem 1A-10: Complete the block diagram in **Figure 1-25**. Complete all visible sides to the block diagram, and add strike and dip symbols and fold axial trace symbols to the map surface. Note the stream on the map surface.

Problem 1A-11: Complete the block diagram in **Figure 1-26**. Add strike and dip symbols, unit abbreviations, HW/FW, U/D labels to the map surface. Add fault displacement arrows where appropriate. Note the stream on the map surface. Classify the fault on the diagram.

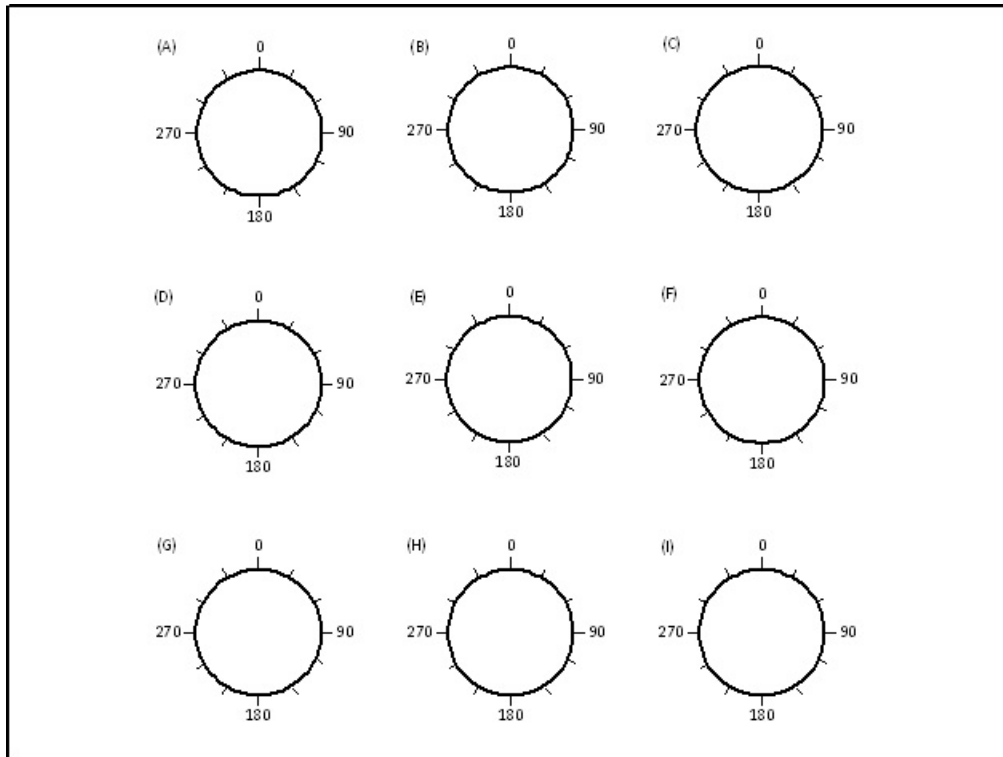
Problem 1A-12: Complete the block diagram in **Figure 1-27**. Add strike and dip symbols, HW/FW labels, U/D labels, fold symbols, etc., to the map surface. Add fault displacement arrows where appropriate. Complete the vertical sides of the block diagram as completely as possible and label the units. Classify the fault on the diagram.



**Figure 1-16** : Diagram for problem 1A-1.



**Figure 1-17** : Diagram for problem 1A-2



**Figure 1-18** : Diagram for problem 1A-3.

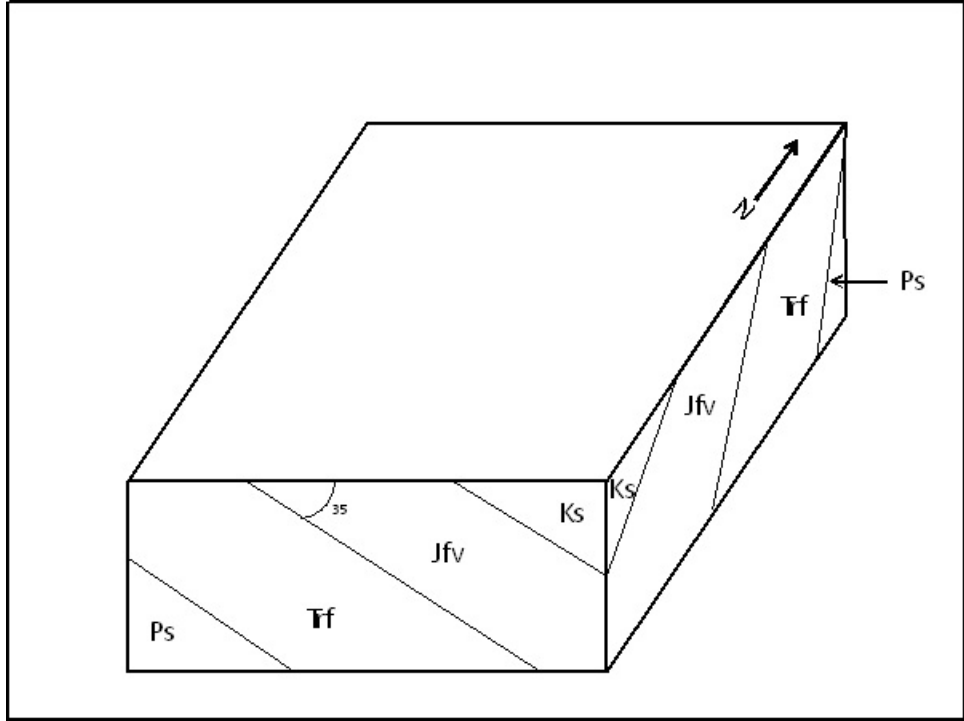


Figure 1-19 : Diagram for problem 1A-4.

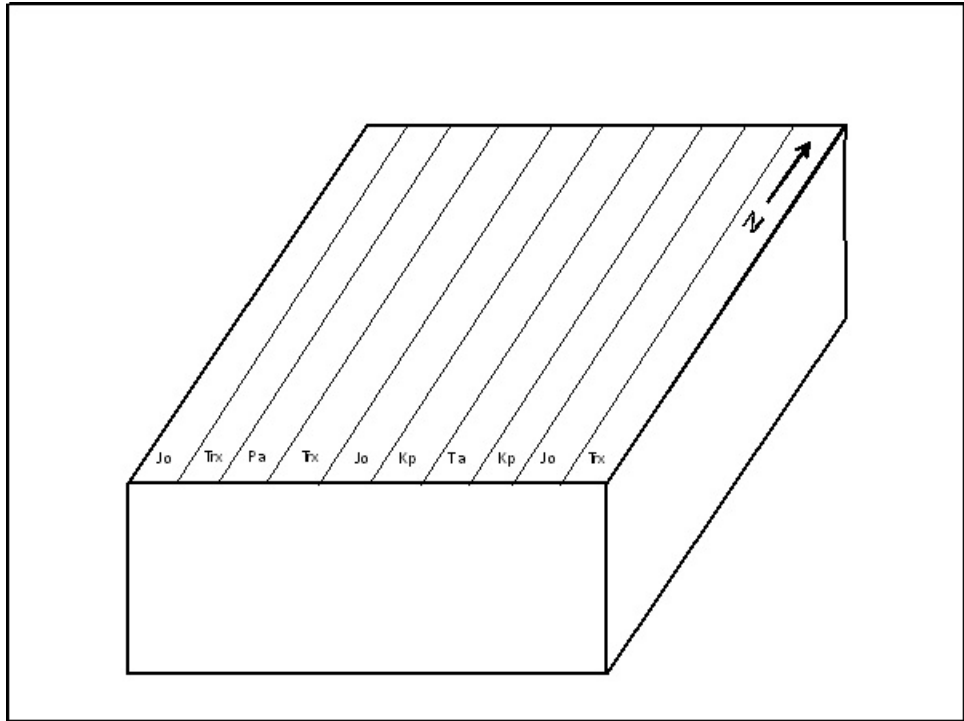
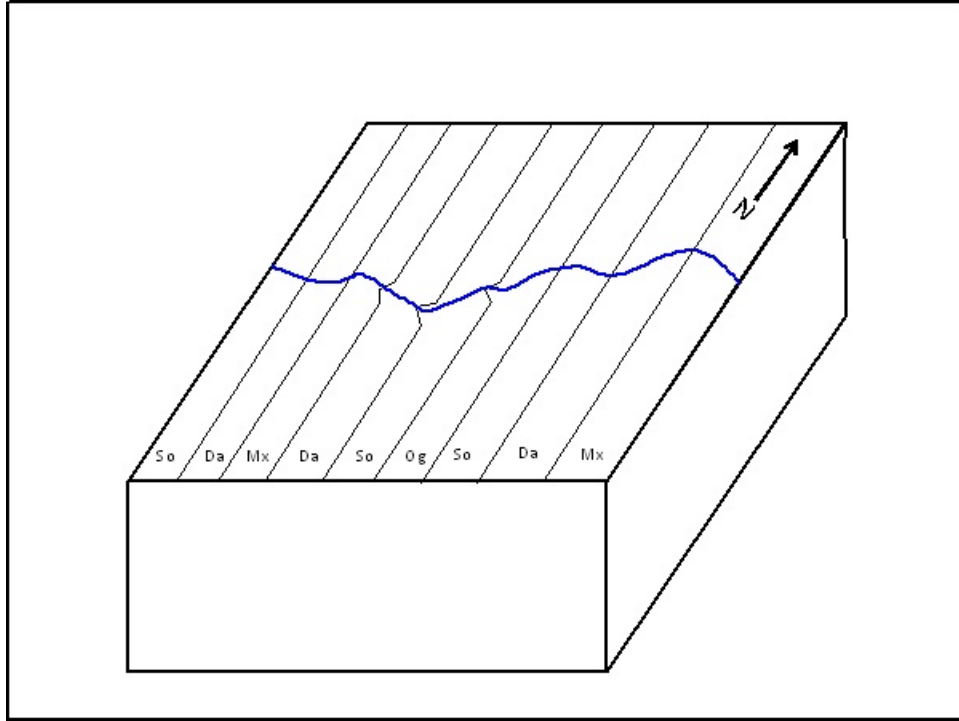
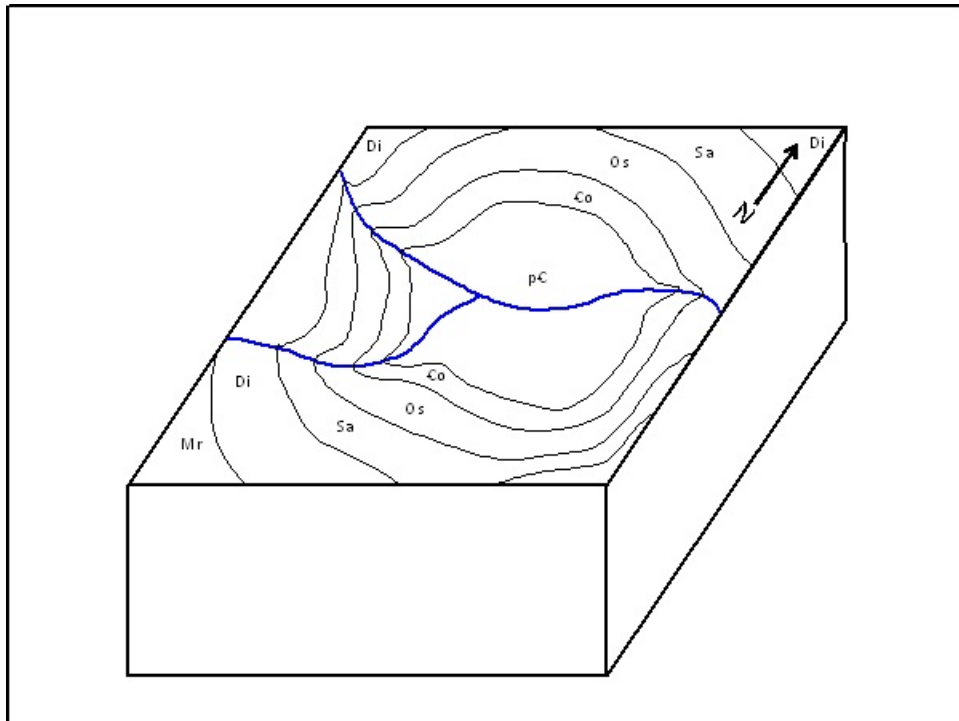


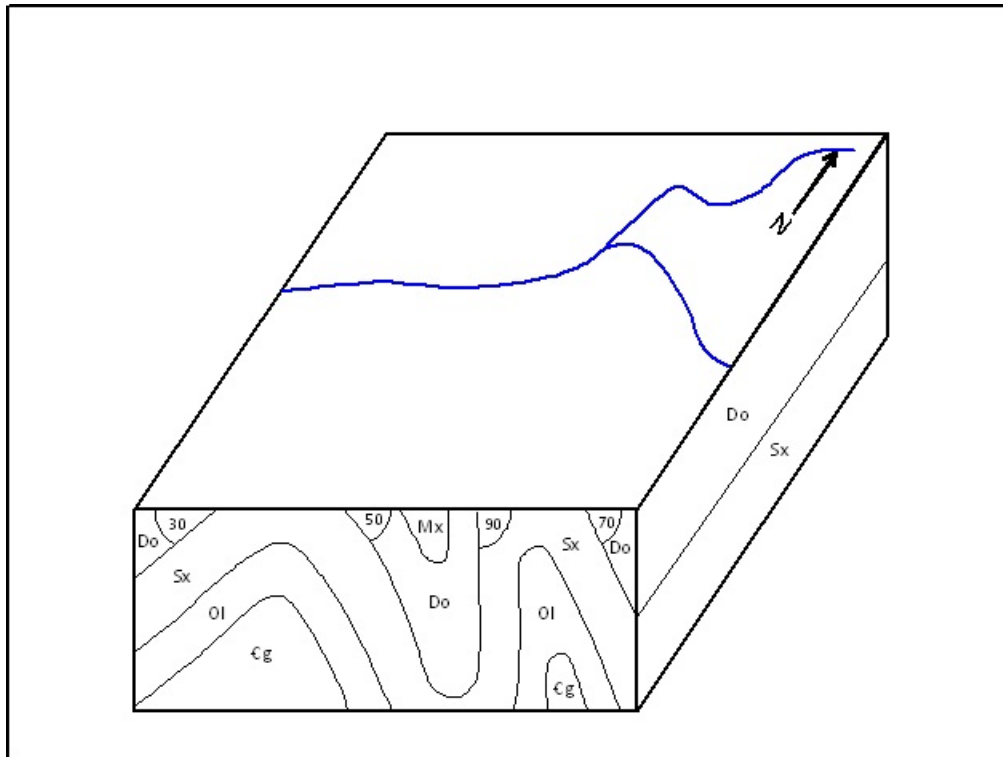
Figure 1-20 : Diagram for problem 1A-5



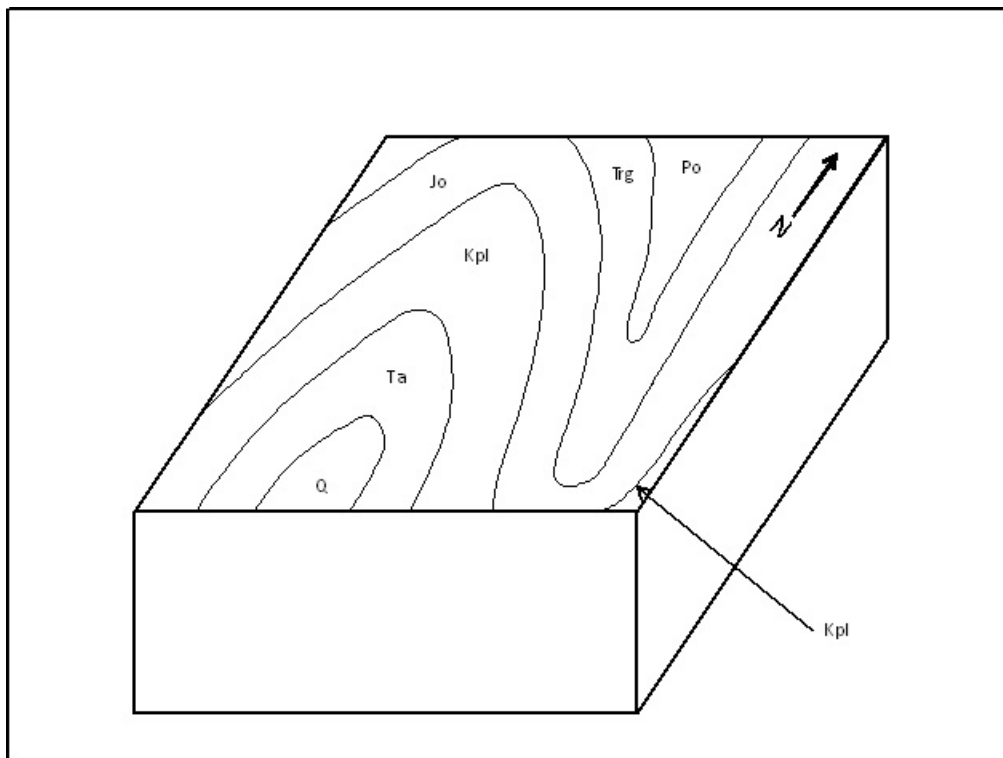
**Figure 1-21** : Diagram for problem 1A-6.



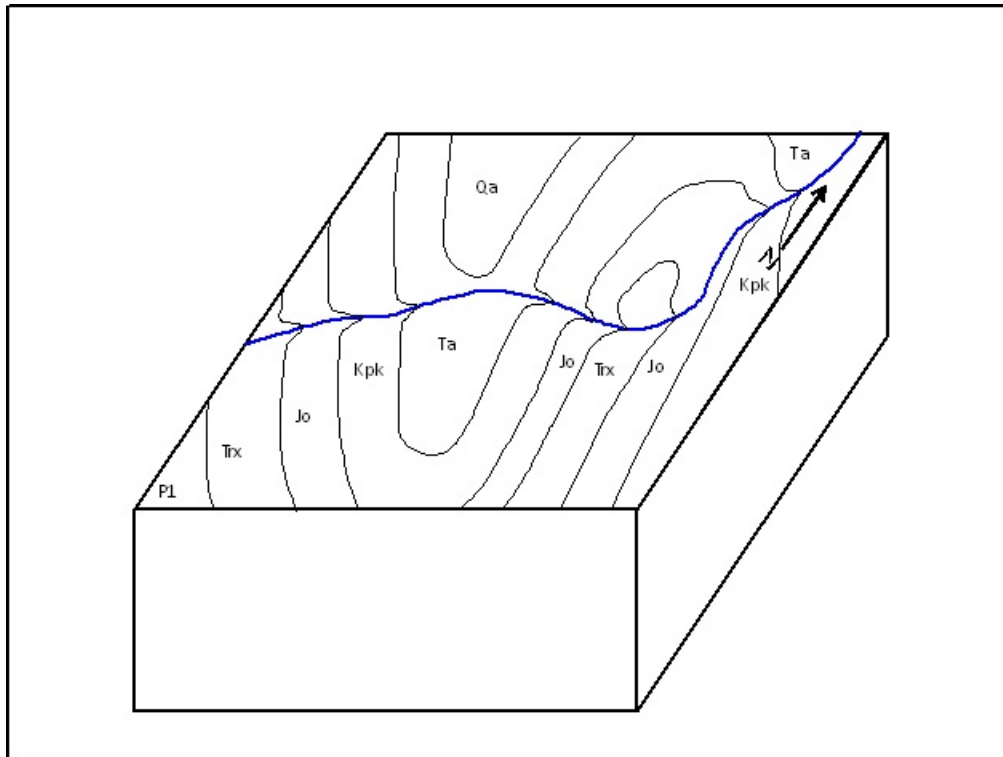
**Figure 1-22** : Diagram for problem 1A-7.



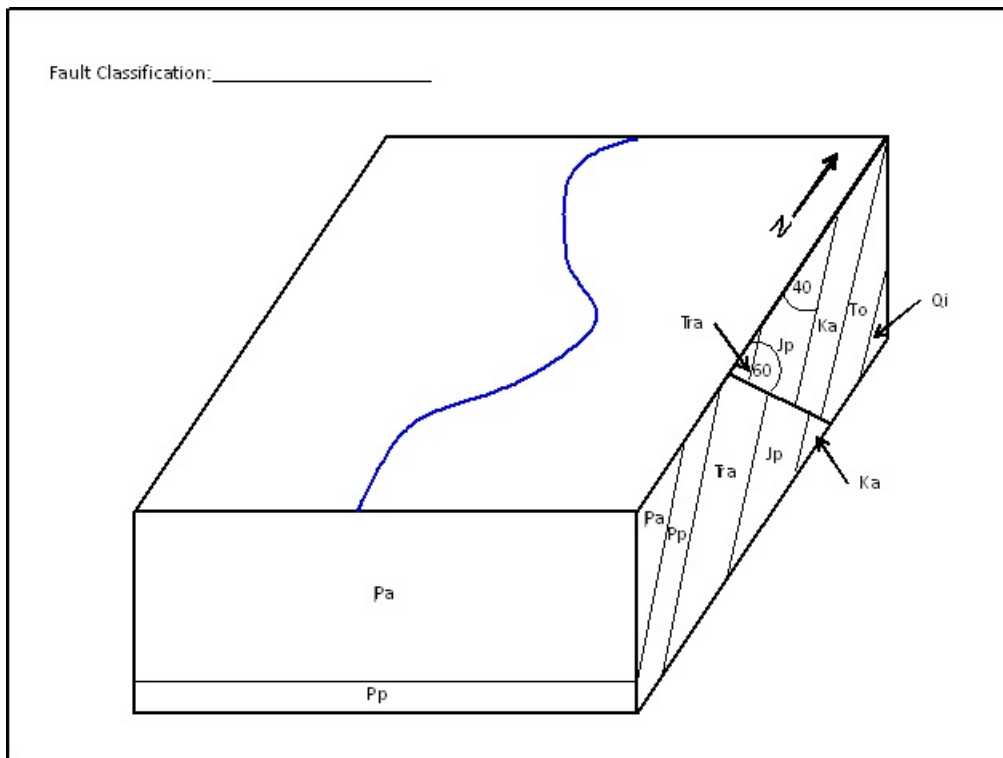
**Figure 1-23** : Diagram for problem 1A-8.



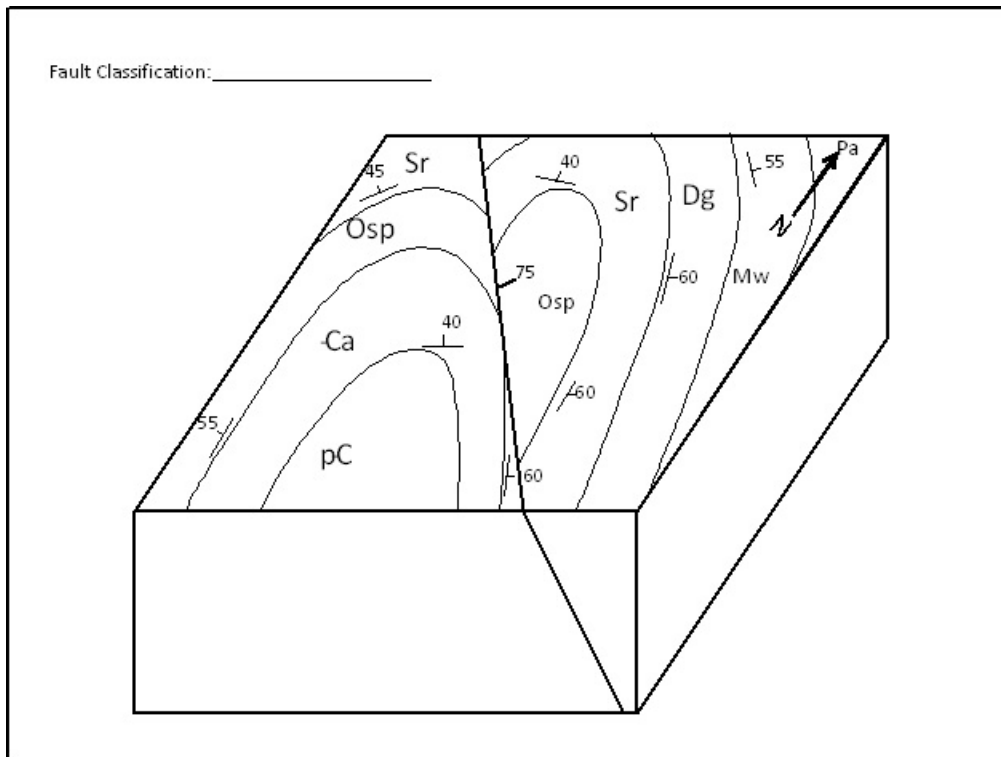
**Figure 1-24** : Diagram for problem 1A-9.



**Figure 1-25** : Diagram for problem 1A-10.



**Figure 1-26** : Diagram for problem 1A-11.



**Figure 1-27** : Diagram for problem 1A-12.

EXERCISE 1B: Geological Attitudes and 3D Block Diagram Interpretation

Problem 1B-1: Using **Figure 1-28** fill in the below matching items with the proper planar attitude. Use the “Strike azimuth, Dip angle and dip quadrant” format for your answer (ex. 045, 65 SE) unless otherwise indicated..

- (A) \_\_\_\_\_ (B)\_(quad)\_\_\_\_\_ (C) \_\_\_\_\_  
(D) \_\_\_\_\_ (E) \_\_\_\_\_ (F) \_\_\_\_\_  
(G)\_(rt. hand)\_\_\_\_\_ (H) \_\_\_\_\_ (I)\_(dip az.& pl.)\_\_\_\_\_

Problem 1B-2: Given the below planar attitudes fill in the **Figure 1-29** diagram with the proper bedding symbol. Note that the below planar formats vary:

- (A) 270, 64 N (B) N60W, 61SW (C) 030, 05NW  
(D) 300, 07NE (E) Rt. Hand: 120, 67 (F) N30W, 90  
(G) Dip trend & plunge: 240, 25 (H) 090, 77 N OT (I) horz. (Dip=0)

Problem 1B-3: Given the below linear attitudes fill in the **Figure 1-30** diagram with the proper lineation symbol. Note that the below linear formats vary:

- (A) 120, 15 (B) 300, 05 (C) 15, 210  
(D) 030, 50 (E) 060, 00 (F) 000, 90  
(G) 03, S60E (H) 32, N60E (I) 270, 47

Problem 1B-4: Using the block diagram in **Figure 1-31** add relevant information to the map surface portion of the block diagram. Include strike and dip symbols in each stratigraphic unit on the map surface. Label each stratigraphic unit with the proper abbreviation. If the true dip amount can be determined use it with the strike and dip symbol.

Problem 1B-5: Complete the block diagram in **Figure 1-32**. Add the contact lines and unit abbreviations on all sides to the block diagram, and add strike and dip symbols on the surface face. Note the stream on the surface face of the block diagram.

Problem 1B-6: Complete the block diagram in **Figure 1-33**. Add the contact lines and unit abbreviations on all sides to the block diagram, and add strike and dip symbols on the surface face. Note the stream on the surface face of the block diagram.

Problem 1B-7: Complete the block diagram in **Figure 1-34**. Complete all visible sides to the block diagram, and add strike and dip symbols to the map surface. Add appropriate fold symbols and label strata with age labels.

Problem 1B-8: Complete the block diagram in **Figure 1-35**. Complete all visible sides to the block diagram, and add strike and dip symbols to the map surface. Add appropriate fold symbols and label strata with age labels. Note the stream on the map surface.

Problem 1B-9: Complete the block diagram in **Figure 1-36**. Complete all visible sides to the block diagram, and add strike and dip symbols to the map surface. Note the stream on the map surface. Write the name of the structure in the upper left corner.

Problem 1B-10: Complete the block diagram in **Figure 1-37**. Complete all visible sides to the block diagram, and add strike and dip symbols to the map surface. Add appropriate fold symbols and label strata with age labels.

Problem 1B-11: Complete the block diagram in **Figure 1-38**. Complete all visible sides to the block diagram, and add strike and dip symbols to the map surface. Add appropriate fault symbols and label strata with age labels. Write the fault classification in the upper left corner.

Problem 1B-12: Complete the block diagram in **Figure 1-39**. Complete all visible sides to the block diagram, and add strike and dip symbols to the map surface. Add appropriate fault symbols and label strata with age labels. Write the fault classification in the upper left corner.

Problem 1B-1

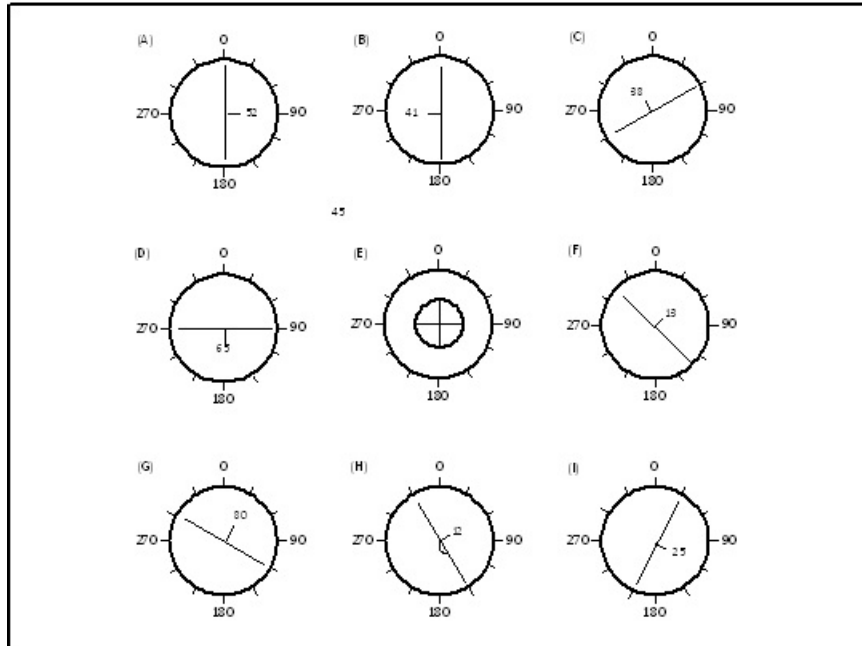


Figure 1-28 : Figure for problem 1B-1.

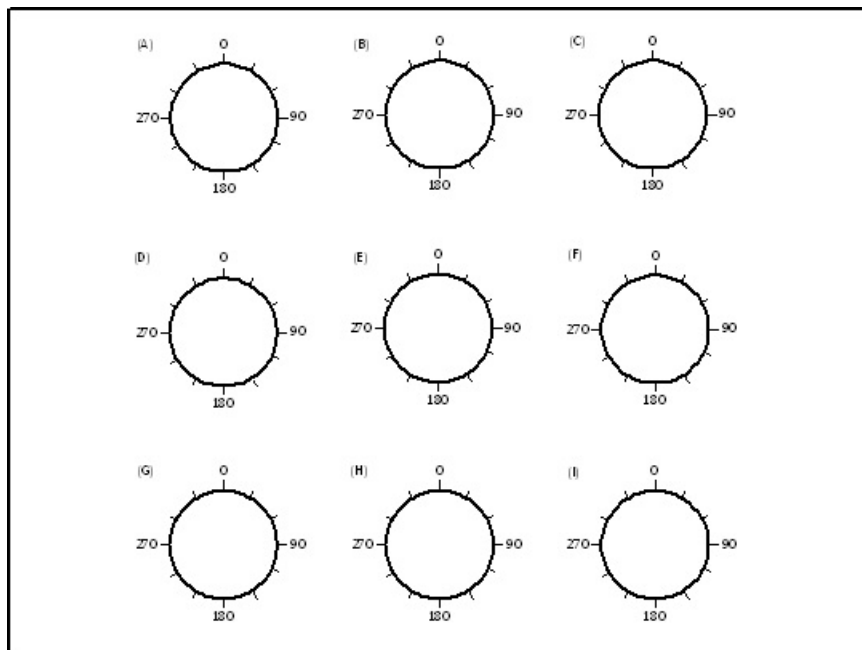


Figure 1-29 : Diagram for problem 1B-2.

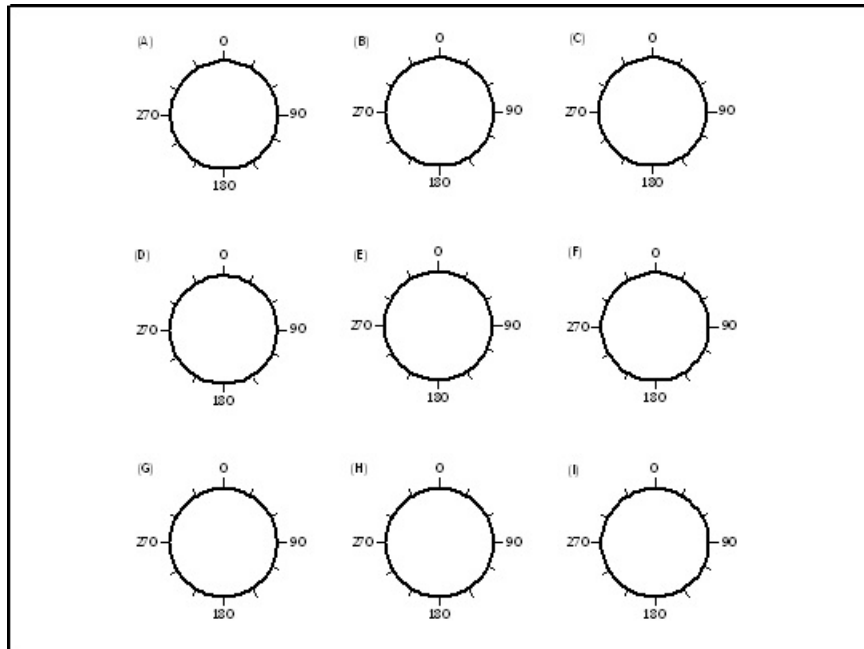


Figure 1-30 : Diagram for problem 1B-3.

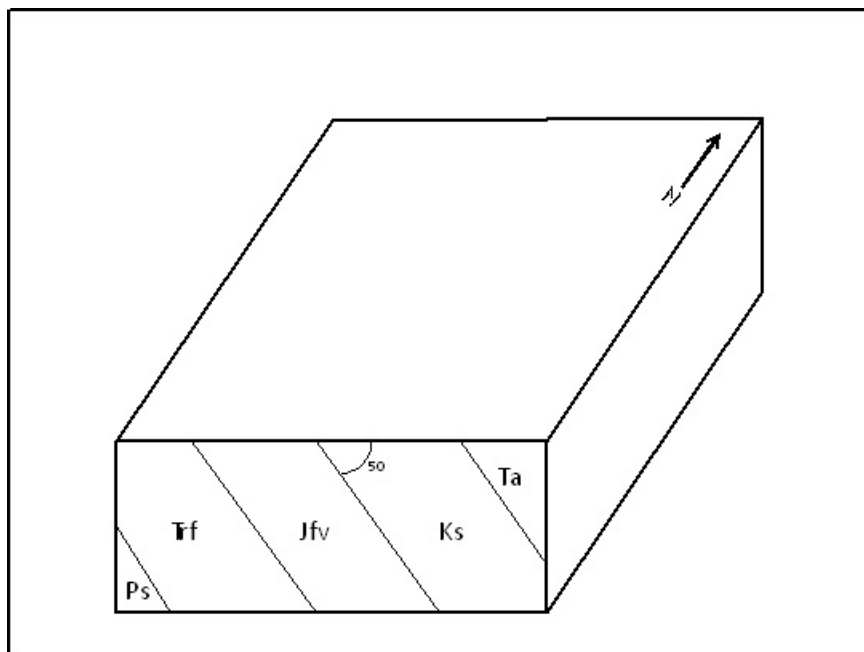


Figure 1-31 : Diagram for problem 1B-4.

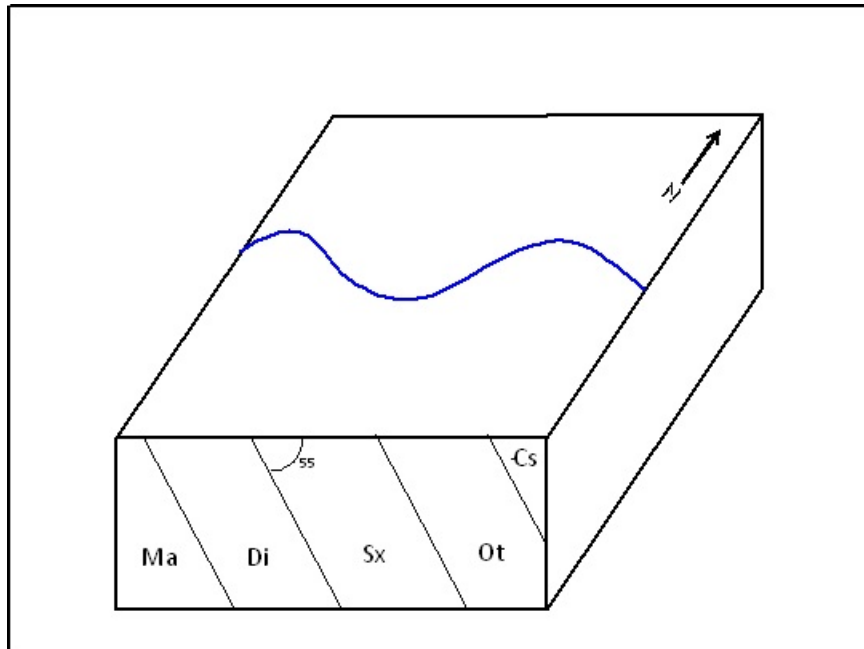


Figure 1-32 : Diagram for problem 1B-5.

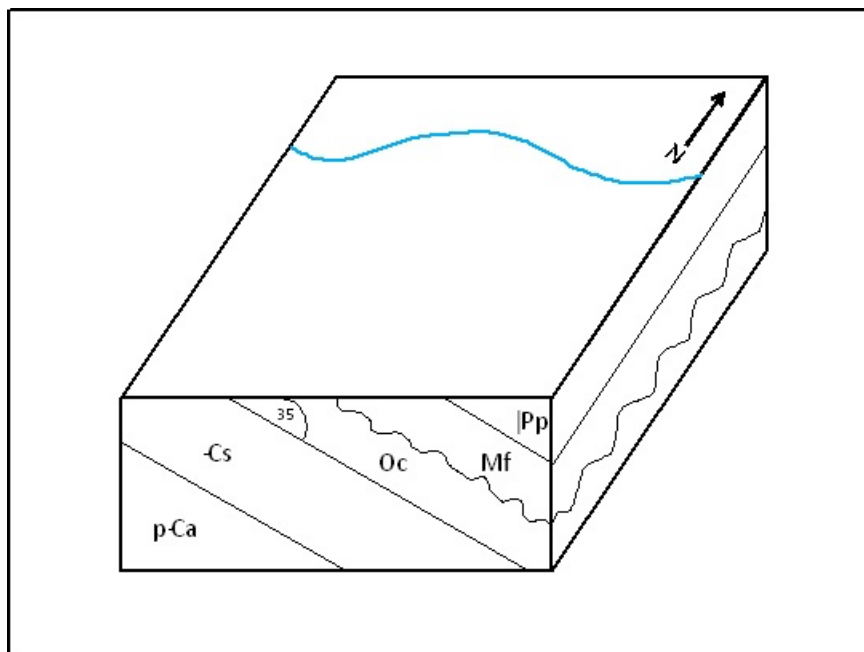
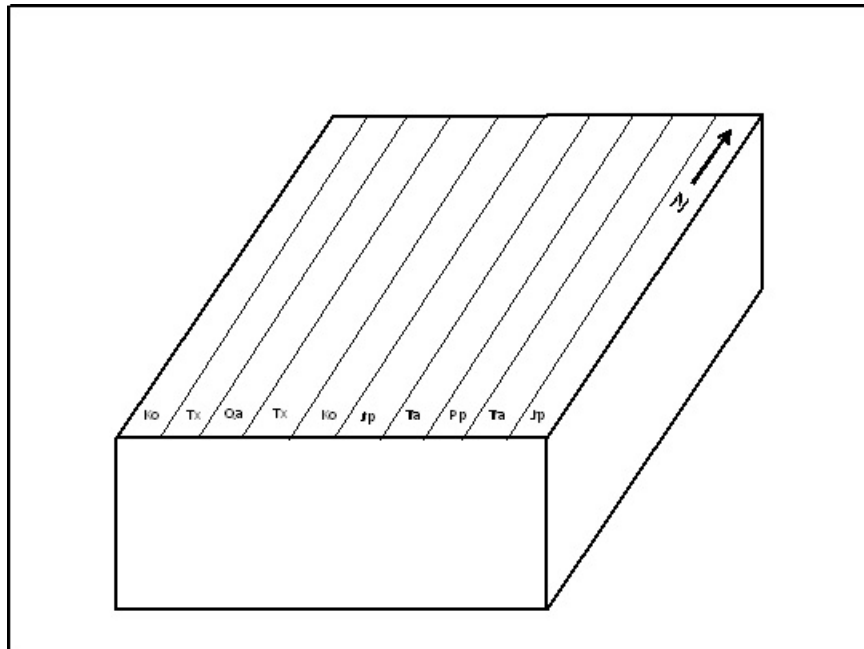
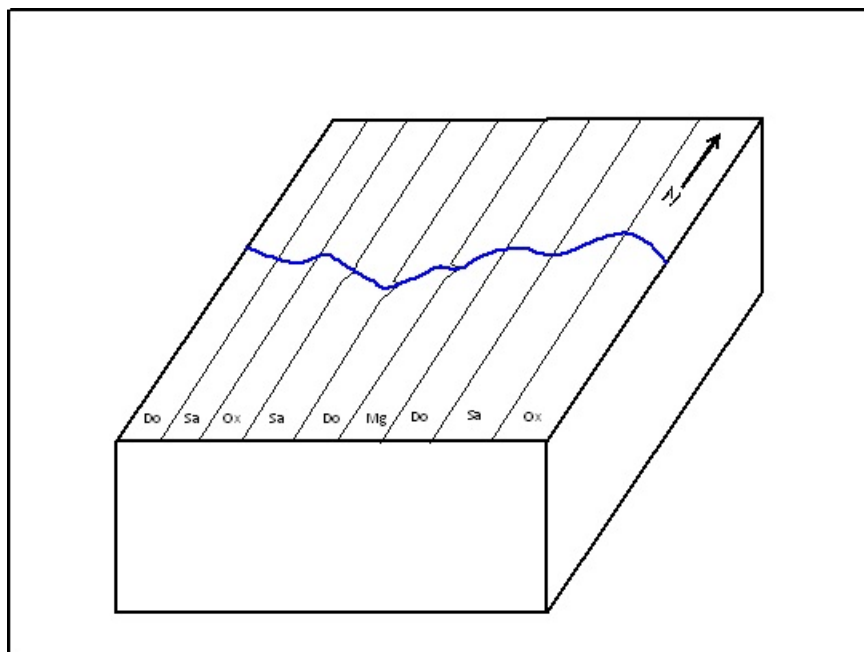


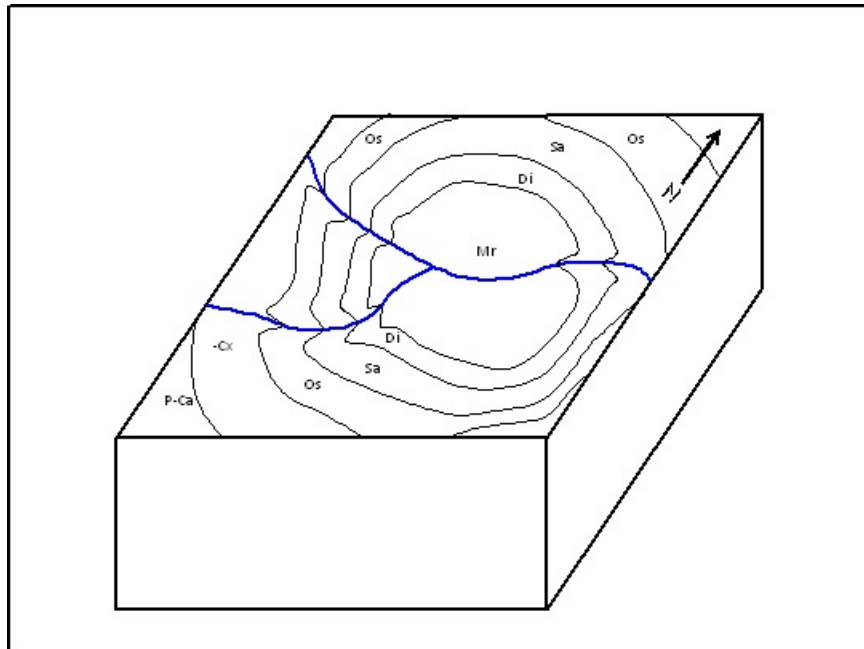
Figure 1-33 : Diagram for problem 1B-6.



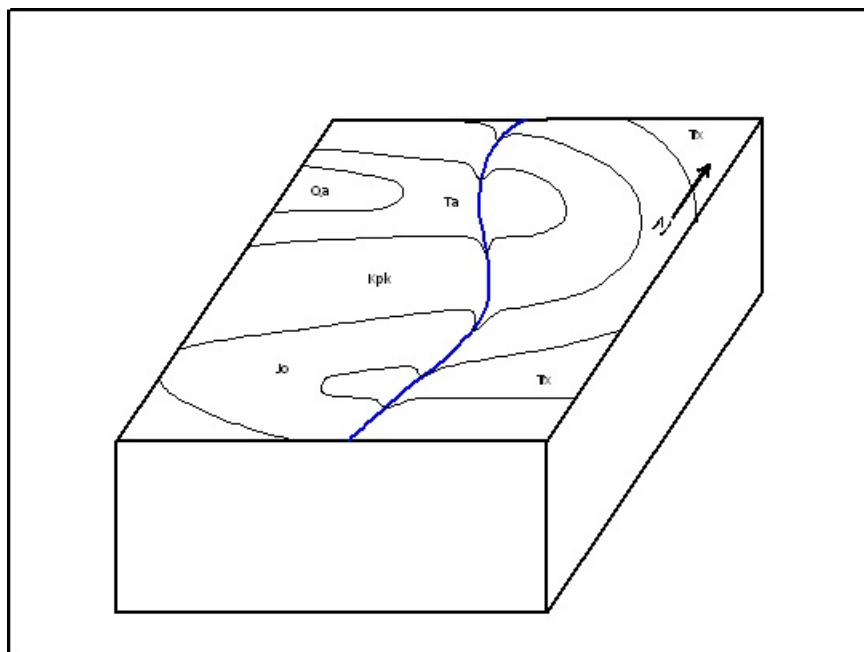
**Figure 1-34** : Diagram for problem 1B-7.



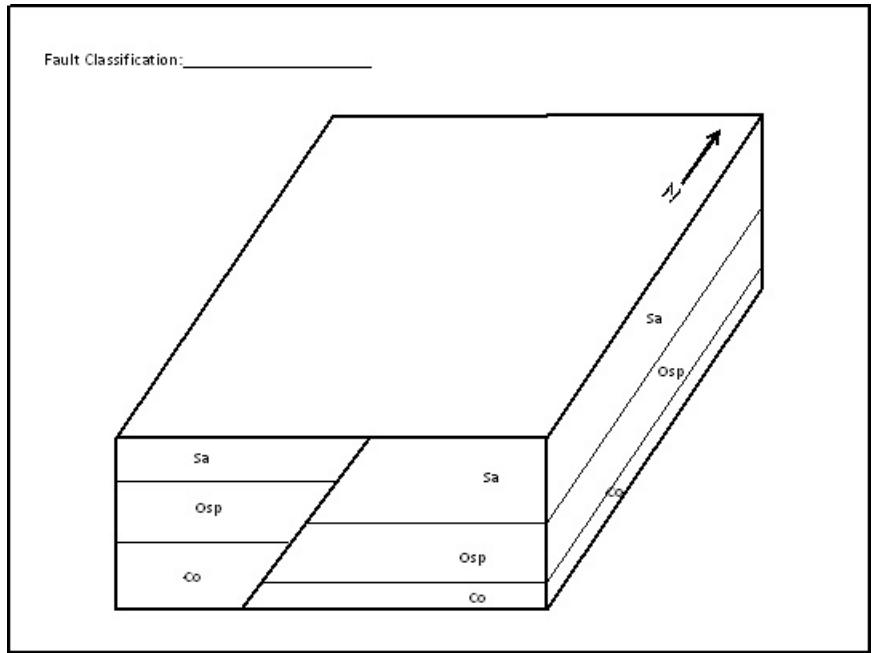
**Figure 1-35** : Diagram for problem 1B-8.



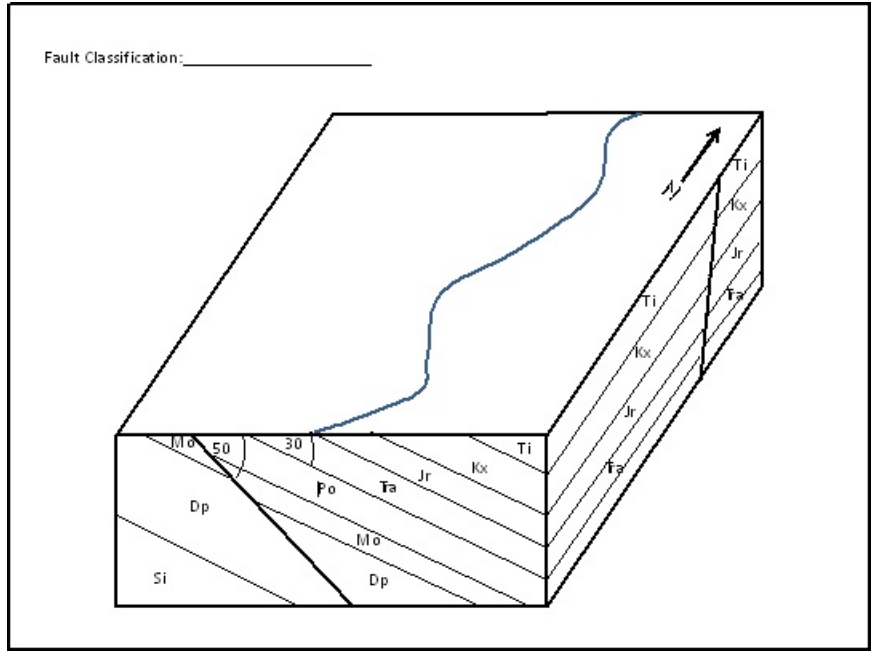
**Figure 1-36** : Diagram for problem 1B-9.



**Figure 1-37** : Diagram for problem 1B-10



**Figure 1-38** : Diagram for problem 1B-11.



**Figure 1-39** : Diagram for problem 1B-12

## LABORATORY 2: Orthographic Projections for Solving True/Apparent Dips and Three-Point Problems.

### I. True and Apparent Dip Calculations

(A) Given strike and true dip, calculate the apparent dip in a specific direction.

Apparent dips are required whenever a cross-section intersects strike at some angle other than 90 degrees.

(B) Methods

1. Graphical (demonstrated in class with orthographic construction).

Problem 1: Given strike and true dip of  $050^\circ$ ,  $40^\circ$  SE, find the apparent dip in a vertical cliff trending  $110^\circ$  (S $70^\circ$  E).

Answer:  $110^\circ$ ,  $36^\circ$  (S $70^\circ$  E,  $36^\circ$ )

Problem 2: Given two apparent dips of :

(1)  $200^\circ$ ,  $35^\circ$  (S $20^\circ$ W,  $35^\circ$ )

(2)  $130^\circ$ ,  $25^\circ$  ( S $50^\circ$ E,  $25^\circ$ )

Find the strike and true dip of the plane that contains these two apparent dips.

Answer:  $271^\circ$ ,  $36$ SW (N $89^\circ$  W,  $36^\circ$ SW)

2. Mathematical Solution with Excel Spreadsheet (IntersectingPlanes.xlsm, CommonPlane.xlsm)

The spreadsheets for calculating apparent dip solutions may be downloaded from:

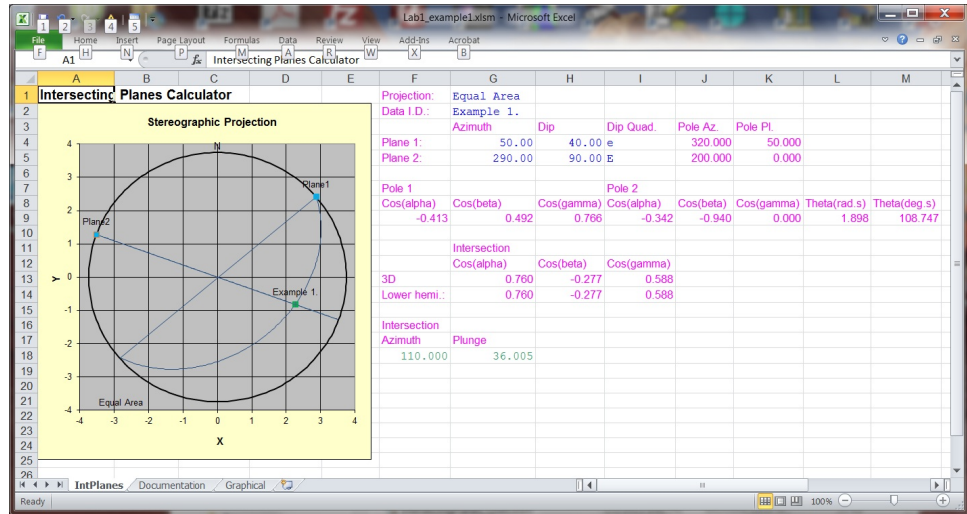
<http://www.usouthal.edu/geography/allison/GY403/StructureSpreadsheets.html>

The spreadsheet "IntersectingPlanes.xlsm" is an Excel spreadsheet that calculates the plunge and bearing of the line of intersection between 2 given planar attitudes (strike & dip). Note that the apparent dip direction should be treated as a vertical plane. The spreadsheet "CommonPlane.xlsm" calculates the strike and true dip of a plane that contains 2 apparent dip linear (plunge & bearing) attitudes.

Problem 1:  
 Given strike and true dip of  $050^\circ$ ,  $40^\circ$  SE, find the apparent dip along the trend of  $110^\circ$ .

The solution is displayed in **Figure 2-1**. Note that

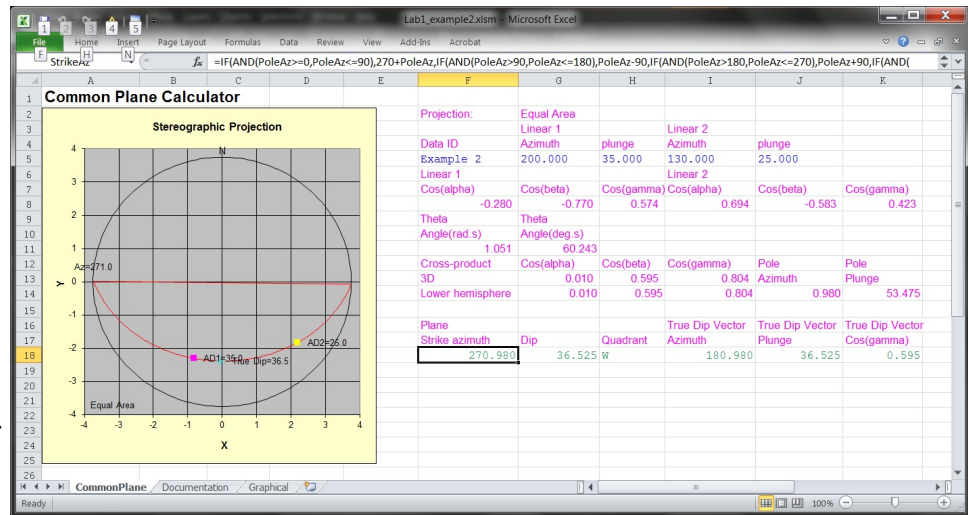
the input data is in blue text and the solution is in the green text. The stereographic diagram in **Figure 2-1** will be explained in later lab chapters.



**Figure 2-1** : Example problem 1 solution in spreadsheet form.

Problem 2:  
 Given two apparent dips of:

- (1)  $35^\circ$ ,  $S20^\circ W$  (200)
  - (2)  $25^\circ$ ,  $S50^\circ E$  (130)
- Find the strike and true dip of the plane that contains these two apparent dips.



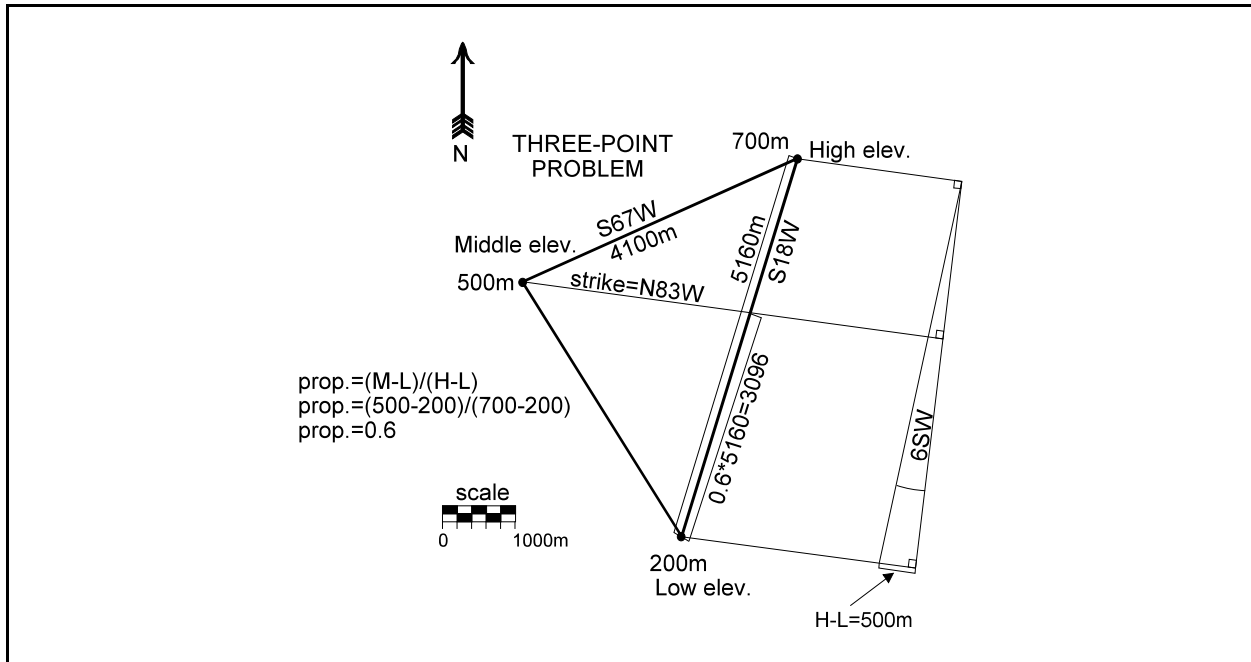
**Figure 2-2** : Example problem 2 solution in spreadsheet form.

Answer:  $271^\circ$ ,  $37^\circ$  SW

The solution is provided in the **Figure 2-2** diagram.

## II. Three Point Problems

(A) Graphical Method:



**Figure 2-3** : Diagram of a three-point problem solution.

Given three points of known location and elevation that mark the outcrop of a plane can always be used to calculate the strike and true dip of the plane. (Demonstrated in classroom). **Figure 2-3** is an example of the graphical method.

Answer: 277°(N83° W), 06° SW

If two of the three points are the same elevation, they will define the strike line directly. In this variation of the problem only the dip must be calculated.

Remember to convert drill hole data to actual elevations before working the problem (i.e. subtract the depth from the topographic elevation).

Solve the problem in the below steps. Refer to **Figure 2-3** as the steps to the problems progress:

1. Plot the three points with elevation values labeled. These are the points labeled “High”, “Middle”, and “Low” in **Figure 2-3**. Hereafter these points are known as H, M, and L respectively.
2. Connect all three points with straight reference lines to form a triangle.

3. Label the distances according to the map scale along each side of the triangle. For instance, the side connecting L and H in **Figure 2-3** is 5240 meters.

4. Visualize the side of the triangle that connects L and H. The strike of the structural plane that passes through L, M, and H will originate at M and pierce the L-H side at an elevation equal to M, in this case 500 meters above sea level. This point on the L-H line is proportional to the relative elevation differences between L, M, and H. Another way of visualizing this is to imagine that you could walk along the L-H edge of the structural plane starting at point L. Since elevation would increase progressively from L to H there must be a point on the edge equal to M. This point, along with the M apex of the triangle, gives two points on the plane that have the same elevation. Therefore, the strike line with elevation equal to 500 meters must connect these two points. In **Figure 2-3**, the distance from point L to the M elevation on the L-H edge is calculated by solving for the relative proportion of  $(M-L)/(H-L)$ . This distance is 3096 meters. This determines the strike to be N83W.

5. Draw a line parallel to the strike line that passes through the H and L points. Since you know the horizontal distance between these two strike lines from the map scale, and you know the vertical change in elevation (H-L) also, you can solve for the dip angle either graphically or mathematically.

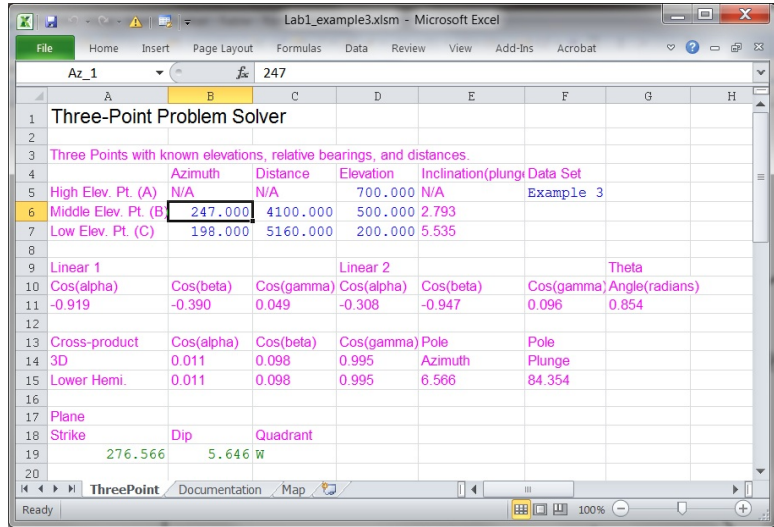
6. To solve for the dip angle graphically, draw a line perpendicular to the H and L strike lines such that it passes across both. On the L strike line, mark off a distance equivalent to the elevation difference between these H and L according to the original map scale (i.e. no vertical exaggeration allowed). In **Figure 2-3** you will note the distance equal to a 500 meter elevation change (H-L) is marked off. On the L strike line, starting where the elevation difference was measured, connect a line from this point back to where the perpendicular intersects the H strike line. This new line will define the dip angle if you measure the angle inscribed between the new line and the strike perpendicular. The perpendicular to the two strike lines is, in effect, a fold line that displays the trace of the dipping plane. This fold line should be imagined to have an elevation equivalent to strike line H. In the **Figure 2-3**, the dip angle and direction is  $6^\circ$  SW.

(B) Mathematical solution with Excel Spreadsheet (ThreePoint.xls)

The Excel spreadsheet “ThreePoint.xls” may be used to mathematically determine the strike and true dip of the plane that contains three points of known map position and elevation. The spreadsheet is designed to use a specific convention when entering the elements of the three-point problem. If a structural plane passes through the points in **Figure 2-4**, the high elevation point (700m) is point “H”, the middle elevation point (500m) is “M”, and the low elevation (200m) point is “L”. The bearing direction from “H” to “M” (S67W) and from “H” to “L” (S18W) must be determined with a protractor, and the map distance from “H” to “M” (4100m) and from “H” to “L” (5160m) also must

be determined with a scale.

**Figure 2-4** contains the above information entered into the “ThreePoint.xlsm” spreadsheet (blue text). Note that the answer (276.6 [N83W], 5.6SW) is displayed in green text. Make sure that all values are measured from the map accurately, and are entered into the spreadsheet accurately. Also note that the spreadsheet is set to use 2 decimal places for angles, therefore, all angles must be entered with 2 decimal places. Because of the mathematical precision of the spreadsheet the final answer will be more precise than the graphical orthographic method.

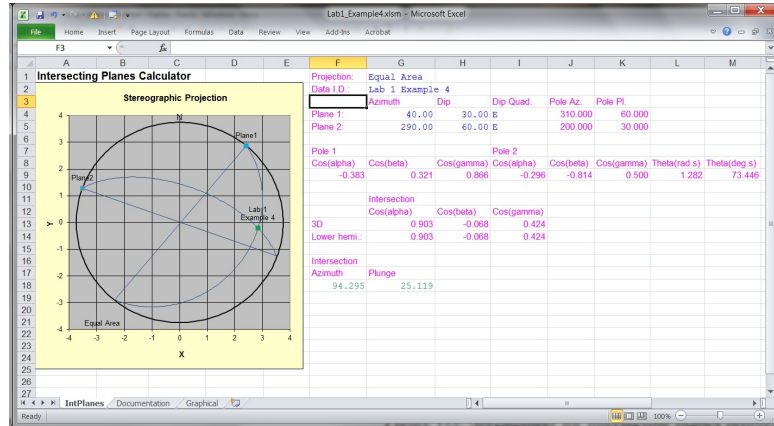


**Figure 2-4** : 3-point problem example in a spreadsheet.

### III. Plunge and Bearing of the Line of Intersection of 2 Planes

A) Given the strike & dip of two non-parallel planes calculate the plunge and bearing of the intersection of the planes.

**Example Problem:** Two non-parallel dikes intersect each other at an exposure. Dike 1 is oriented 040°, (N40° E), 30° SE and Dike 2 is oriented 290° (N70° W), 60° NE. What is the attitude of the line formed by the intersection of these dikes?



**Figure 2-5** : Spreadsheet for intersecting planes problem.

Answer: 094°, 25°

1. Orthographic method demonstrated in class.
2. Mathematical method demonstrated in **Figure 2-5** spreadsheet (IntersectingPlanes.xlsm).



EXERCISE 2A: Orthographic Projections.

Problem 1: A bed has a known strike and dip of  $045^\circ, 35^\circ\text{NW}$ . Find the apparent dip in a vertical cliff trending  $090^\circ$ .

Problem 2: The strike of a bed can be measured on the flat top of an outcrop, but the dip cannot be determined at this location. The apparent dip of the same bed can be measured on several vertical faces that do not trend perpendicular to the strike of the bedding. With the information given below, determine the complete planar attitude of the bedding in each case (A and B). Do separate page constructions for (A) and (B).

Apparent Dip	Trend of Apparent Dip	Strike of Bed
(A) $40^\circ$	$035^\circ$	$090^\circ$
(B) $15^\circ$	$310^\circ$	$345^\circ$

Problem 3: Find the strike and true dip of the contact between two uniformly planar beds where two apparent dips –  $053^\circ, 37^\circ$ ;  $026^\circ, 44^\circ$  – were obtained.

Problem 4: The Drummond Coal Co. encountered the top of the Blue Creek coal seam with three different drill holes. The hole depths were: (A) 1100'; (B) 650'; and (C) 850'. Hole (B) is 3300'  $\text{N}10^\circ\text{E}$  of (A), hole (C) is 2700'  $\text{N}60^\circ\text{W}$  of (A). As you are the geologist on site, you are charged with finding the strike and dip of the coal seam so that the company can proceed with mine development. Assume that the drilling of all three holes started on a flat horizontal surface. Scale  $1'' = 1000$  feet.

Problem 5: Three drill holes were sunk on the map included in **Figure 2-6**. The drilling at all three sites encountered the top of a mineralized basaltic lava flow at various depths below the land surface. Find the attitude of the top of the flow assuming it is planar. The below information is provided:

(Site A) Depth to top of flow = 550 m.

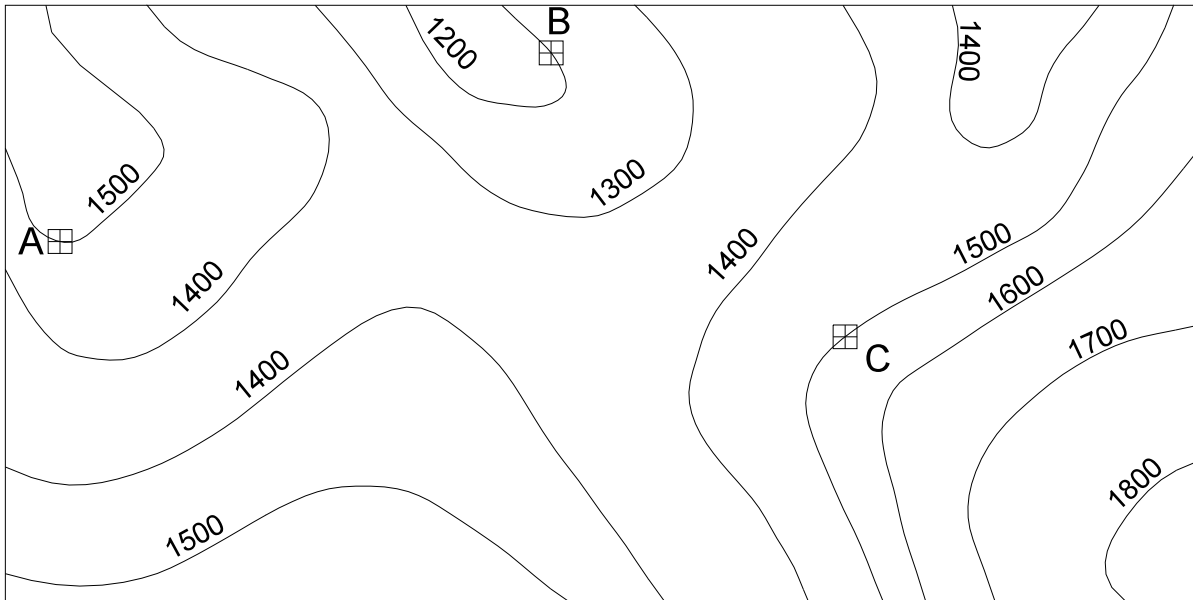
(Site B) Depth to top of flow = 650 m.

(Site C) Depth to top of flow = 300 m.

Scale:  $1'' = 1000$  m. Contour interval: 100 m.

Problem 6: A chevron fold has a west limb attitude of  $340, 30\text{NE}$  and an east limb attitude of  $050, 60\text{NW}$ . If the hinge of the fold is formed by the intersection of these two planar limbs, what is the trend and plunge of the hinge?

GY-360 LAB  
EXERCISE 1  
PROBLEM 5  
SCALE: 1"=1000m



CONTOUR INTERVAL=100m

Figure 2-6 : Map for problem 5.

EXERCISE 2B: Orthographic Projections.

Problem 1: A bed has a known strike and dip of  $335^\circ, 65^\circ\text{SW}$ . Find the apparent dip and bearing in a vertical cliff section trending  $270^\circ$ .

Problem 2: The strike of a bed can be measured on the flat top of an outcrop, but the dip cannot be determined at this location. The apparent dip of the same bed can be measured on several vertical faces that do not trend perpendicular to the strike of the bedding. With the information given below, determine the complete planar attitude of the bedding in each case, (A) and (B). Do separate page constructions for (A) and (B).

Apparent Dip	Direction of Apparent Dip	Strike of Bed
(A) $30^\circ$	$055^\circ$	$025^\circ$
(B) $25^\circ$	$210^\circ$	$345^\circ$

Problem 3: Find the strike and true dip of the contact between two uniformly planar beds where two apparent dips –  $034^\circ, 20^\circ$ ;  $334^\circ, 54^\circ$  – were obtained. Check your results using the mathematical method discussed in your lab manual. Show the mathematical method in the lower right corner of your construction, or as an attached spreadsheet printout.

Problem 4: On the provided **Figure 2-7** USA campus map, the top of a clay unit outcrops at the locations indicated by points A, B, and C (in red) on the map. Calculate the strike and true dip of the unit assuming that it is a planar structure. Construct the problem at the scale of the map (1 inch = 1000 feet). In addition to reporting the dip in degrees, also list the true dip in feet per mile units.

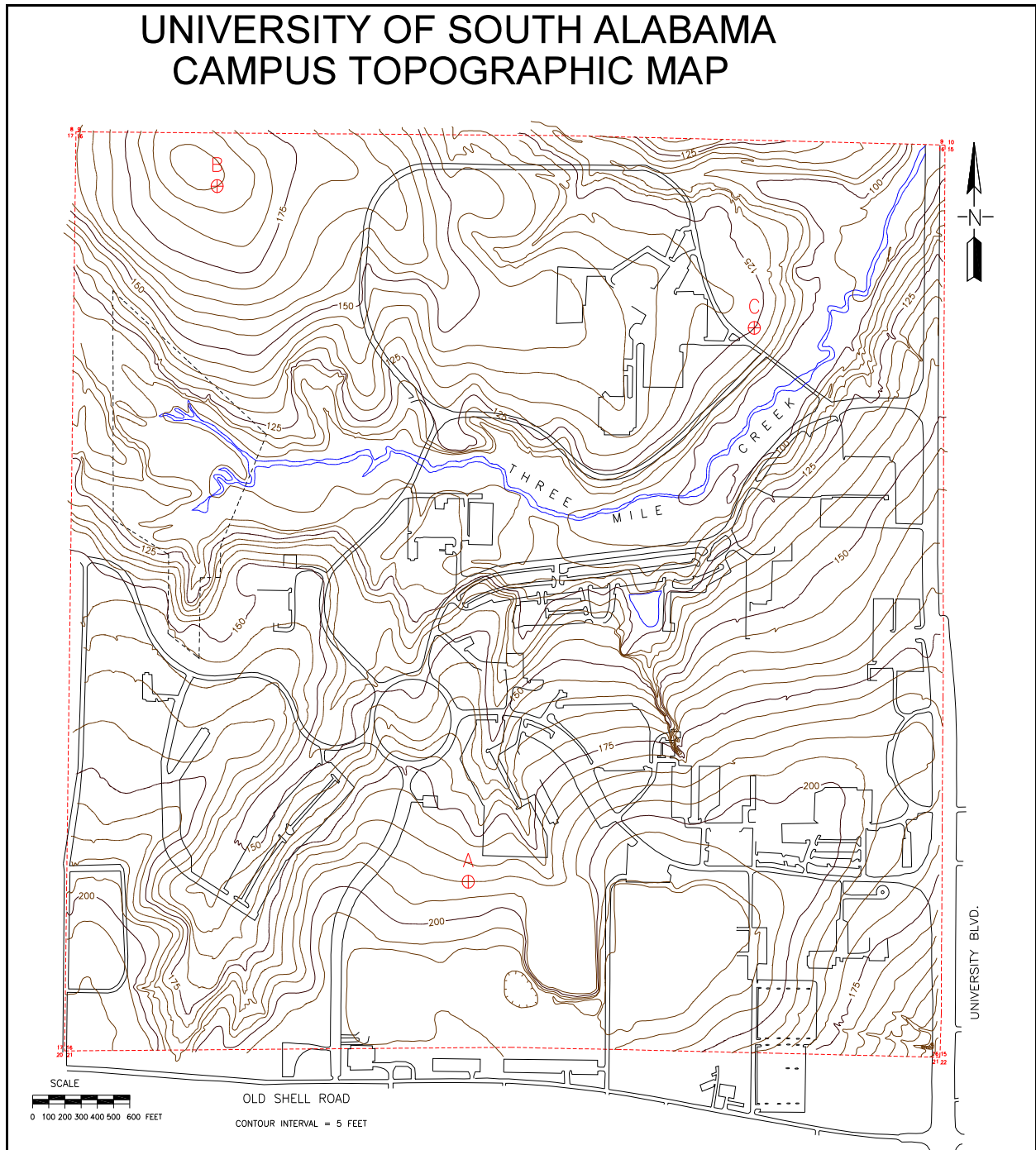
Problem 5: Calculate the strike and true dip of the planar stratigraphic contact between the Mdg and Mh (both Mississippian) formation exposed in the central portion of the **Figure 2-8** geologic map (taken from northeast corner of the Dromedary Peak Quadrangle, Utah). Use the A, B, and C control points:

- (A) contact crosses the 9400 foot contour
- (B) contact crosses the 9000 foot contour
- (C) contact crosses the 8400 foot contour

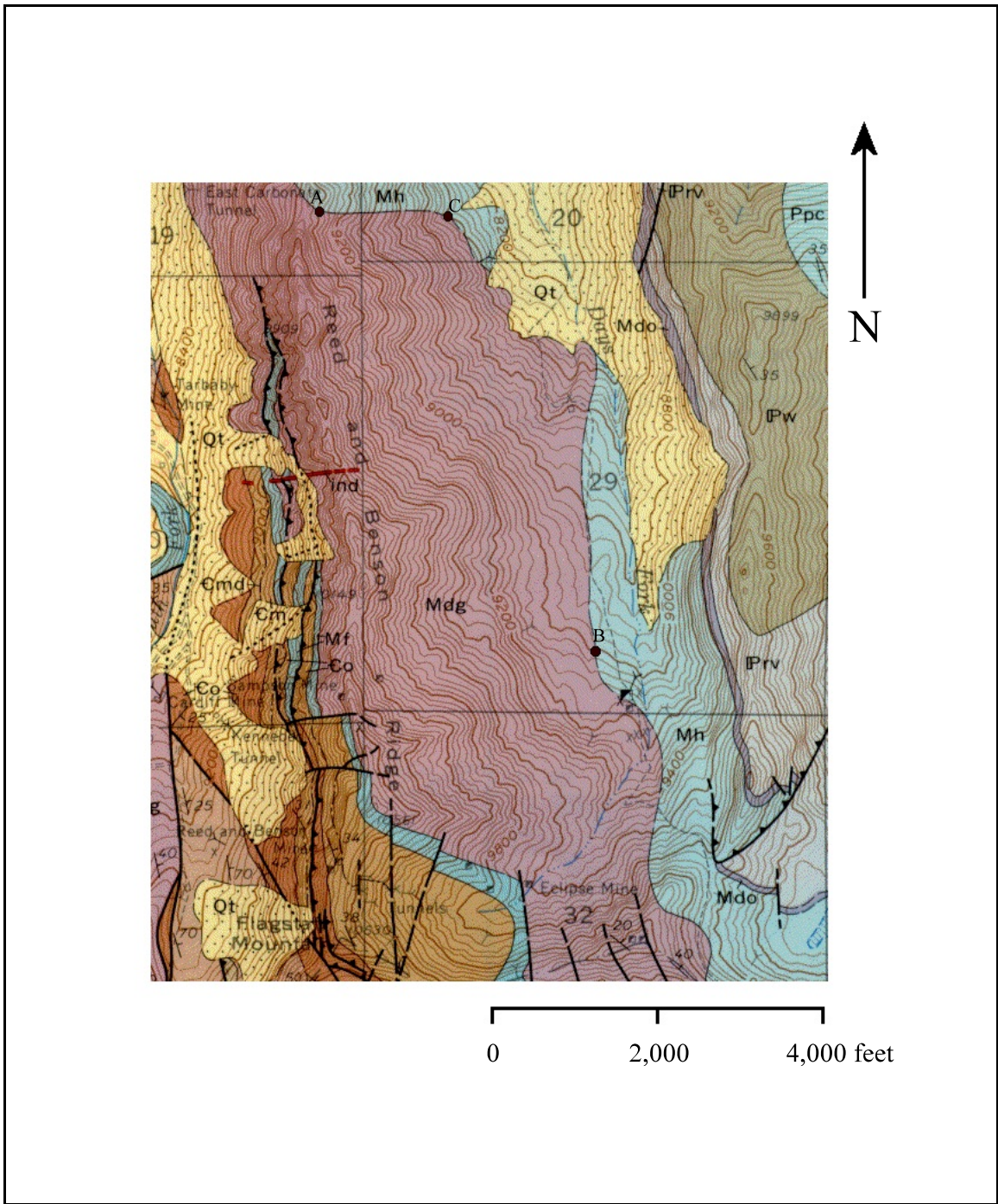
Use the provided scale (1 inch = 2,000 feet).

Problem 6: A high concentration of uranium occurs at the intersection of a  $040^\circ, 60^\circ\text{NW}$  fault and a  $350^\circ, 40^\circ\text{NE}$  sandstone bed. The intersection of the bed and the fault crops out in a wash north of the True Blue Mine in western Arizona. The owners of the mine have decided to explore the uranium play by drilling it. If they start the drill-hole at the outcrop, what should be the trend and plunge of the drill-hole such that it follows the intersection.

# UNIVERSITY OF SOUTH ALABAMA CAMPUS TOPOGRAPHIC MAP



**Figure 2-7 :** Topographic map of the USA campus with 3 contact points A, B, and C.



**Figure 2-8** : Geologic map of a portion of the Dromedary Quadrangle, Utah.



## LABORATORY 3: Basic Stereographic Projections

### I. Stereographic Projections

a) Two types

1. *Equal-area* (also referred to as a Schmidt net)
2. *Equal-angle* (also referred to as a Wulff net)

b) Equal-angle stereonet are used in crystallography because the plotted angular relationships are preserved, and can be measured directly from the stereonet plot.

c) Equal-area stereonet are used in structural geology because they present no statistical bias when large numbers of data are plotted. On the equal-area net area is preserved so, for example, each  $2^\circ$  polygon on the net has the same area.

d) In structural geology the stereonet is assumed to be a *lower-hemisphere projection* since all structural elements are defined to be inclined below the horizontal. This is unlike crystallographic projections where elements may plot on either the upper or lower hemisphere.

### II. Elements of the Stereonet

a) The outer perimeter of the stereonet is termed the *primitive*. The primitive is always a perfect circle. Usually the diameter of the primitive is some convenient length, such as 10 cm.

b) The *north pole* of the stereonet is the upper point where all lines of longitude converge. The *south pole* is the equivalent lower convergence point.

c) Lines that run from the north to south pole of the stereonet are termed *great circles* and are analogous to lines of longitude on a globe. The lines of longitude can be visualized as forming from planes that strike due north and intersect the lower hemisphere at  $2^\circ$  increments. The bolder lines are  $10^\circ$  increments. It is possible to measure the true dip of a plane only along the east-west line. There is one great circle that is a straight line- it runs directly from the north to south polar position.

d) Circular arcs that run east-west are termed *small circles*. Small circles can be visualized by rotating a horizontal line from, for example,  $N20^\circ E$  azimuth around a horizontal and due north azimuth. The path of the end point of the line would describe the small circle that begins at  $N20^\circ E$  and terminates at  $N20^\circ W$ . Note that the amount of rotation would be  $180^\circ$  because we only need inscribe the small circle on the lower hemisphere. The east-west reference line of the stereonet is the only small circle that is

actually a plane. There is only one small circle that is a straight line- it runs from the due east to the due west position.

e) Note that since the plunge of a line is measured in a vertical plane that we can measure the plunge of a line along the east-west or north-south reference lines.

### III. Plotting Planes and Lines on the Stereonet.

a) A plane intersects the lower hemisphere as a great circle. A sheet of tracing paper should be fixed to the center tack of the net to allow rotation. Rotate until the strike attitude is attained and then plot the great circle that corresponds to the correct true dip value. Remember to count the true dip angle from the primitive. Verify the plot by rotating the north reference back to the north point on the net.

b) A vertical plane plots as a straight line diameter on the stereonet. A horizontal plane is the primitive.

c) In many situations it is more convenient to plot the *pole* of a plane rather than the great circle. The pole represents the line that is perpendicular to the plane. Since the intersection of a line with the lower hemisphere is a point, the pole will always plot as a point, and will always have an attitude measured as a plunge and bearing.

d) To plot the pole, find the point along the east-west line where the great circle representation of the plane crosses. From this point count  $90^\circ$  toward the center- this is the pole point. Note that the dip angle of the plane and the plunge of the pole are always complementary angles.

e) A linear structure element will always intersect the lower hemisphere at a point, so, like the pole to a plane, you will always plot linear data as a point.

f) To plot a linear attitude, rotate the bearing of the structure until it is parallel to either the north-south or east-west line (it makes no difference). From the primitive, count toward the center the number of degrees equal to the plunge. Plot the point at this position.

g) Note that a line with a plunge of  $0^\circ$  will plot as two points on the primitive at each end of the bearing line. A plunge of  $90^\circ$  always plots at the center of the net.

### IV. Solving Problems with the Stereonet.

a) You can think of the stereonet as basically a three-dimensional protractor and, just like a two-dimensional protractor, it is useful for determining the angular relationships between three-dimensional lines and/or planes.

b) True and apparent dip problems that can be solved graphically or mathematically can also be solved on the stereonet. In fact, the stereonet is usually the tool of choice for solving these problems because of its speed.

1. Given strike and true dip solve for apparent dip.
2. Given two apparent dips solve for strike and true dip.
3. Given strike and one apparent dip find the true dip angle.

c) The line of intersection of two planes can be found by simply plotting both planes. The point where the two great circles intersect defines the line contained by both planes.

d) The angle between two lines can be determined by plotting both points on the stereonet that represent the two linear elements. Rotate the paper until both points fall on the same great circle. The great circle represents the plane that contains both lines. Counting the number of small circle angular divisions between these two points yields the angle between the two lines.

e) The angle between two lines in a common plane - the *rake angle* is one example - can be determined easily with the stereonet. The angle is measured by counting the amount of angular arc between the two points along the great circle representing the plane.

f) Example problems from Orthographic projections laboratory

Problem 1: Given strike and true dip of N50° E, 40° SE, find the apparent dip along the bearing of S70° E.

Manual Stereonet Method:

1. Using a plotted stereonet grid with NETPROG place a tracing paper overlay on the grid and label the cardinal directions and the center point.
2. Plot the given strike and true dip, N50° E, 40° SE, as a great circle.
3. With the overlay "North" mark aligned with grid north mark the apparent dip bearing S70° E on the primitive circle. Rotate this mark to either the east or west end of the stereonet grid. Count from the primitive inward along the E-W line until the great circle line is encountered. This angle is the apparent dip amount.

NETPROG Stereonet Method:

Make sure NETPROG is installed on your computer. You can download and setup the NETPROG program from the below web site:

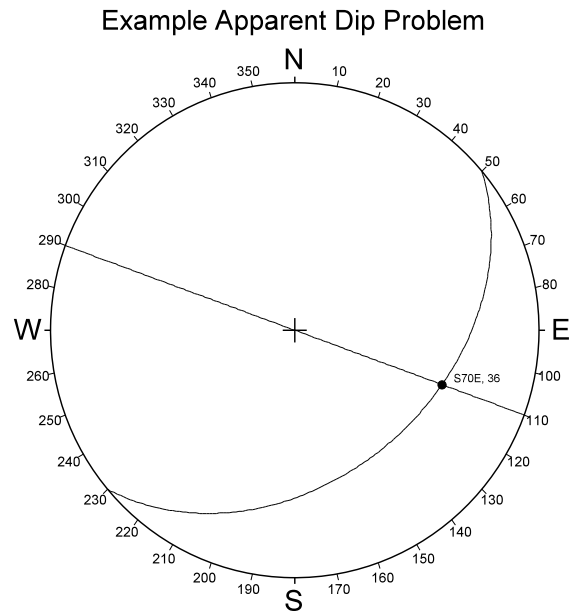
<http://www.usouthal.edu/geography/allison/w-netprg.htm>

1. With NETPROG active go the "Draw" > "Great Circle" menu item. In the dialog make sure that the attitude format is "QuadPlanes" and enter the attitude "N 50 E 40 E".

Select the “OK” button and NETPROG will then draw the great circle.

2. You wish to find the apparent dip along the S 70 E bearing, and that is essentially the same as “slicing” the N 50 E 40 E plane vertically along a S70E - N70W direction and then measuring the plunge angle of the line produced by these intersecting planes. Therefore, select the “Draw” > “Great Circle” again, and then enter “N 70 W 90 E” and select “OK”. NETPROG will draw the 2<sup>nd</sup> great circle (this great circle is vertical so it is in fact a straight line).

3. Using the mouse right button, or the annotation grid window, select both of the great circles. You will see the great circles appear in a gray color when selected. Choose the menu sequence “Solve” > “Intersecting planes”. In the dialog select the “Solve” button, which will then calculate the linear attitude of the intersection of the selected planes (S 70.0 E 36.0). The plunge angle of this attitude is the apparent dip (36.0). Selecting the “OK” button will also plot a marker symbol at the intersection point. The stereonet diagram is displayed in **Figure 3-1**.



**Figure 3-1** : Example apparent dip problem worked with NETPROG.

Problem 2: Given two apparent dips of :

- (1) 35°, S20°W
- (2) 25°, S50°E

Find the strike and true dip of the plane that contains these two apparent dips.

Manual Stereonet Method:

- 1. Mark the cardinal directions and the center of the stereonet on the overlay.
- 2. Plot both of the apparent dips as linear points on the overlay.
- 3. Rotate the overlay until you can find a single great circle that passes through the 2 apparent dip points. Trace the great circle on the overlay. The strike and dip of this great circle is the answer (N89W, 36.5SW).

NETPROG Stereonet Method

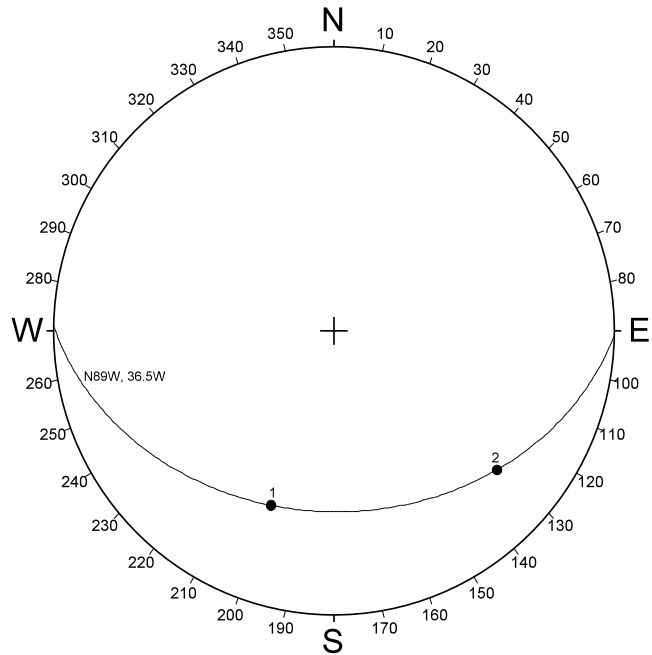
- 1. With NETPROG active use the “Draw” > “Marker” menu to draw two markers at the attitudes of (1) S 20 W 35, and (2) S 50 E 25 (make sure the format is “QuadLines”).
- 2. Select both marker points with right-clicks, and then use the menu item “Solve” >

## Example Strike & Dip Problem

“Common Plane”. In the dialog window click on the “Solve” button to determine the attitude of the plane that passes through the two marker points (N89W, 36.5W). The great circle will be drawn on the diagram after selecting “OK”.

**Figure 3-2** contains the NETPROG solution to the above example problem.

Problem 3: Two non-parallel dikes intersect each other at an exposure. Dike 1 is oriented N40E, 30SE and Dike 2 is oriented N70W, 60NE. What is the attitude of the line formed by the intersection of these dikes?



### Manual Stereonet method

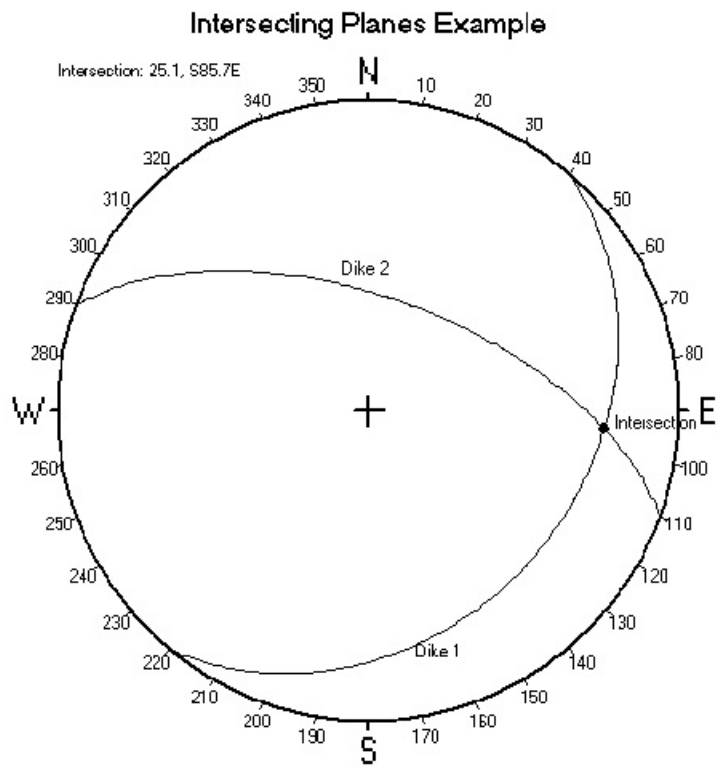
1. Plot each strike and dip as a great circle.
2. Where the great circles intersect (**Figure 3-3**) indicates the plunge and bearing of the intersection

**Figure 3-2** : Example Strike and Dip Problem worked in NETPROG.

### NETPROG Stereonet Method

1. Plot both strike and dip attitudes using the “Draw” > “Great Circle” menu options. Note that a “handle” cross symbol appears at the pole relative the each great circle.
2. Right-click with the mouse on both great circle “handles” to select both great circles. Both should “highlight” in a gray color.
3. Choose the “Solve” > “Intersecting Planes” option and click on the “Solve” button. The bearing and plunge will appear in the edit box labeled “linear attitude”. The position of the intersection will be plotted as a marker symbol (S 85.7 E 25.1).

4. Note that you can highlight the marker and then double-left click on the highlighted symbol to bring up a properties window that will have the attitude indicated.



**Figure 3-3 :** Example intersecting planes problem.

### EXERCISE 3A: Stereographic Projections I

When you construct your plot make sure that you use a compass to draft the perimeter of the stereonet. Always include a tic mark with an "N" to indicate the north reference. Label all great circles and points on the plot. Construct a "+" in the center of the stereonet where the tack hole was located during construction of the problem.

You should use a stereonet with a radius of 3.5 inches to plot the below problems. The windows program "NETPROG" can be used (and will be demonstrated in lab) to plot a net of this size. You should use an equal-area projection (Schmidt).

Problem 1: A bed has an attitude of  $040^\circ, 60^\circ\text{SE}$ . What is its apparent dip trend and plunge in a vertical plane trending  $090^\circ$ ?

Problem 2: The vertical faces of a strip mine trend  $270^\circ$  and  $000^\circ$  respectively. A coal seam has apparent dip of  $20^\circ$  in the  $000^\circ$  wall and  $40^\circ$  in the  $270^\circ$  wall. What is the strike and true dip of the coal seam?

Problem 3: Two dikes with orientations of:

- (1)  $060^\circ, 30^\circ\text{SE}$
- (2)  $350^\circ, 60^\circ\text{SW}$

intersect. What is the bearing and plunge of the line of intersection between these two planar structures?

Problem 4: A thin planar bed ( $348^\circ, 35^\circ\text{SW}$ ) intersects a vein ( $027^\circ, 57^\circ\text{NW}$ ). If we assume that both structures are essentially planar geometries, what is the trend and plunge of the line of intersection of the two planes? What is the apparent dip trend and plunge the vein and the bed in the  $270^\circ$  direction?

Problem 5: A formation which strikes  $050^\circ$  displays an apparent dip of  $35^\circ$  in the  $000^\circ$  direction. What is the true dip trend and plunge?

Problem 6: A planar coal seam has an attitude of  $065^\circ, 35^\circ\text{NW}$ . Find the apparent dips along vertical cuts trending:

- (1)  $010^\circ$
- (2)  $340^\circ$
- (3)  $270^\circ$

Problem 7: Given two apparent dips ( $12^\circ$ , N $57^\circ$ W;  $11^\circ$ , S $20^\circ$ E) for a pegmatite dike, and two apparent dips ( $78^\circ$ , N $90^\circ$ E;  $13^\circ$ , S $32^\circ$ W) for a carbonaceous schist layer, find the orientation of both planar structures (quadrant strike and dip format). The presence of graphite in the schist caused a reaction in the pegmatite that produced cassiterite ( $\text{SnO}_2$ ). Starting at the point where the mineralized zone is exposed, along what bearing and plunge would you instruct your mining engineer to sink a mine shaft to mine this ore?

Problem 8: A polydeformed metamorphic rock contains two different mineral lineations that lie within the plane of  $S_1$  foliation:

Mineral lineation (1):  $14^\circ$ , N $10^\circ$ E

Mineral lineation (2):  $58^\circ$ , S $58^\circ$ E

Find the following:

- (a) Attitude of the  $S_1$  foliation plane containing the two mineral lineations (quadrant strike and dip).
- (b) Rake of each lineation relative to the  $S_1$  plane.
- (c) What is the angle between the two lineations as measured within the  $S_1$  plane?

Problem 9: A planar fault contact contains slickenside lineations that trend N $60^\circ$ W. The fault contact has an attitude of N $10^\circ$ E,  $80^\circ$ NW. Find the following:

- (a) What is the bearing and plunge of the slickenside lineation?
- (b) What is the rake angle of the slickenside lineation in the fault plane?

### EXERCISE 3B: Stereographic Projections I

When you construct your plot make sure that you use a compass to draft the perimeter (primitive) of the stereonet. Always include a tic mark with an "N" to indicate the north reference. Label all great circles and points on the plot. Construct a "+" in the center of the stereonet where the tack hole was located during construction of the problem.

You should use a stereonet with a radius of 3.5 inches to plot the below problems. The windows program "NETPROG.EXE" can be used (and will be demonstrated in lab) to plot a net of this size. You should use an equal-area projection (Schmidt).

Problem 1: A bed has an attitude of  $040^\circ, 40^\circ\text{SE}$ . What is the apparent dip trend and plunge in a  $090^\circ$  vertical plane?

Problem 2: The vertical faces of a strip mine trend  $290^\circ$  and  $010^\circ$  respectively. A coal seam has apparent dip of  $24^\circ$  in the  $010^\circ$  wall and  $46^\circ$  in the  $290^\circ$  wall. What is the strike and dip of the coal seam (azimuth strike and dip format)?

Problem 3: Two dikes with orientations of:

- (1)  $070^\circ, 20^\circ\text{SE}$
- (2)  $340^\circ, 70^\circ\text{SW}$

intersect. What is the trend and plunge of the line of intersection between these two planar structures?

Problem 4: A thin, planar bed ( $338^\circ, 45^\circ\text{SW}$ ) intersects a vein ( $037^\circ, 37^\circ\text{SE}$ ). If we assume that both structures are geometric planes, what is the trend and plunge of the line of intersection of the two planes?

Problem 5: A formation that strikes  $070^\circ$  displays an apparent dip of  $25^\circ$  in the  $000^\circ$  direction. What is the trend and plunge of the true dip?

Problem 6: A planar coal seam has an attitude of  $035^\circ, 35^\circ\text{NW}$ . Find the trend and plunge of apparent dips along vertical cuts trending:

- (1)  $010^\circ$
- (2)  $340^\circ$
- (3)  $270^\circ$

Problem 7: Given two apparent dips ( $12^\circ$ , N $57^\circ$ W;  $11^\circ$ , S $20^\circ$ E) for a pegmatite dike, and two apparent dips ( $78^\circ$ , N $90^\circ$ E;  $13^\circ$ , S $32^\circ$ W) for a carbonaceous schist layer, find the orientation of both planar structures. The presence of graphite in the schist caused a reaction in the pegmatite that produced cassiterite ( $\text{SnO}_2$ ). Starting at the point where the mineralized zone is exposed, along what bearing and plunge would you instruct your mining engineer to sink a mine shaft to mine this ore? For your answer list the following:

- a) Attitude of pegmatite dike (quadrant strike and dip format)
- b) Attitude of schist layer (quadrant strike and dip format)
- c) Attitude of mineralized zone (plunge and bearing format)

Problem 8: A polydeformed metamorphic rock contains two different mineral lineations that lie within the plane of  $S_1$  foliation:

Mineral lineation (1):  $24^\circ$ , N $15^\circ$ E

Mineral lineation (2):  $44^\circ$ , S $48^\circ$ E

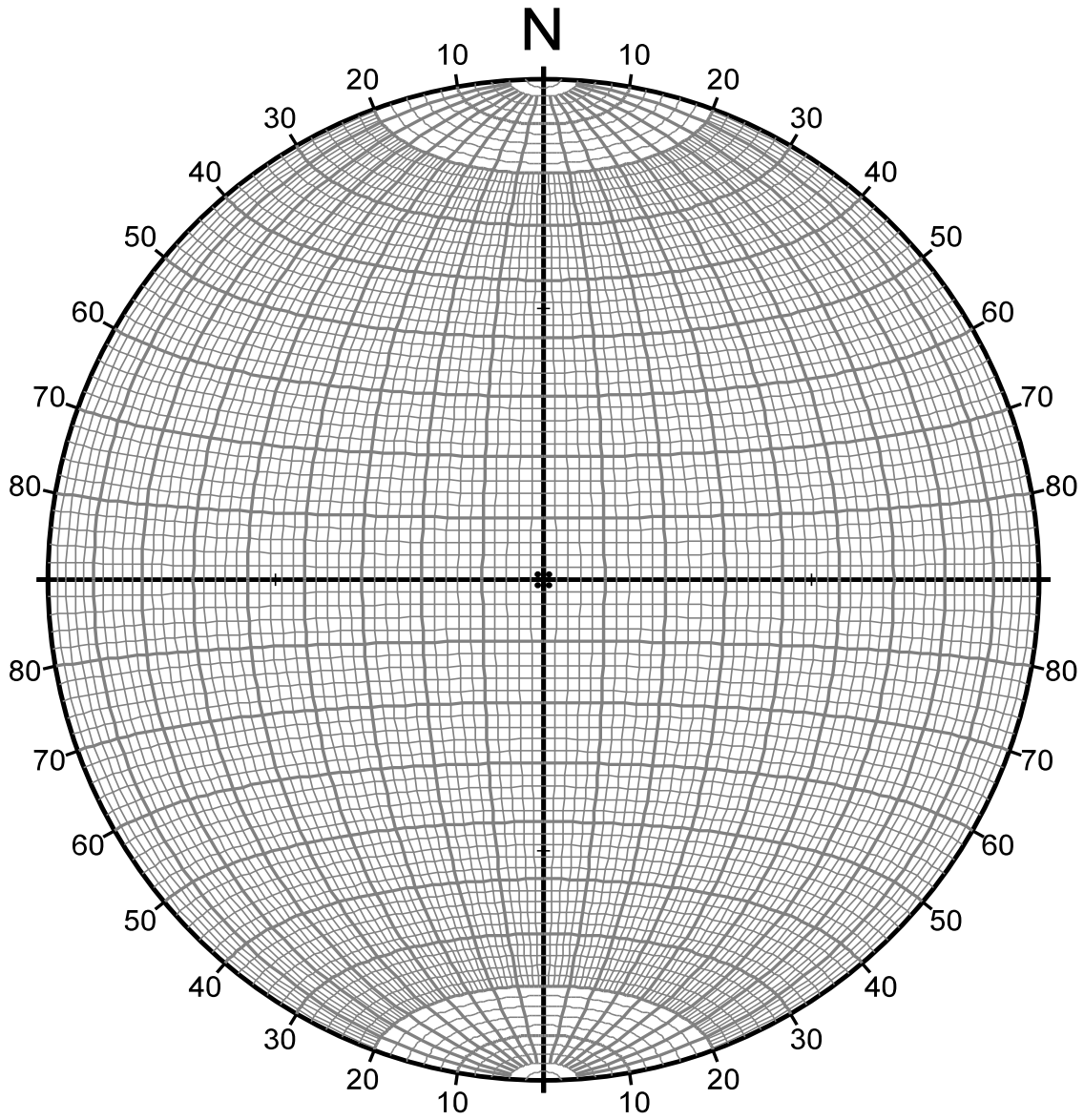
Find the following:

- (a) Attitude of the  $S_1$  foliation plane containing the two mineral lineations (quad. strike and dip).
- (b) Rake of each lineation relative to the  $S_1$  plane.
- (c) What is the angle between the two lineations as measured within the  $S_1$  plane?

Problem 9: A planar fault contact contains slickenside lineations that trend N $50^\circ$ W. The fault contact has an attitude of N $20^\circ$ E,  $60^\circ$ NW. Find the following:

- (a) What is the bearing and plunge of the slickenside lineation?
- (b) What is the rake angle of the slickenside lineation in the fault contact?

# Equal Area Projection



**Figure 3-4 :** Equal-area (Schmidt) stereographic lower-hemisphere projection.

## LABORATORY 4: Rotational Problems with the Stereonet.

### I. Plotting the Pole to a Plane.

- a) Any planar attitude may be represented instead as the perpendicular line to the pole- this is referred to as the *pole*.
- b) The pole is useful in rotation problems precisely because we can directly rotate it about any specified rotation axis. This cannot usually be done with a plane plotted as a great circle. Therefore, the first step of many rotational problems is to plot planar attitudes as a pole. Since the pole represents the attitude of a line its orientation is described by a plunge and bearing, and it plots as a point on the stereonet.
- c) Steps for plotting the pole:
  1. Arrange the tracing paper on the net as you would for plotting the great circle for the planar attitude. Plot the great circle at this time for reference. Do not rotate the tracing paper from this position yet.
  2. With the tracing paper still in (1) position, count  $90^\circ$  along the east-west line from the point where the plotted great circle intersects the east-west line. The direction to count this angle should always be toward the center of the net.
  3. After counting  $90^\circ$  plot a point at this position on the east-west line. This represents the attitude of a line perpendicular (i.e. pole) to the plotted plane. After some practice, you will not need the great circle reference for plotting the pole.

### II. Fold Geometry Elements

- a) Many type of rotation problems consist of undoing the deformational effects of folding- i.e. "unfolding" the fold. To understand the problem you must have a clear understanding of the terminology used to describe folds:
  1. *Fold Hinge*: the line formed by connecting points of maximum curvature within a specific folded surface. The hinge is a physical entity that you can actually see and touch.
  2. *Fold Axis*: the imaginary line that, if moved parallel to itself, could sweep out the folded surface of a fold. Unlike the fold hinge this is an imaginary line, however, it is always parallel to the fold hinge.
  3. *Axial Plane*: the imaginary plane that cuts the fold symmetrically, and which also contains the hinge lines of all affected surfaces.

4. *Fold Limb*: the part of a fold contained between adjacent axial planes. Although these elements are rarely perfect planes, we can often approximate their geometric relationships by assuming that they are planes over short distances.

5. *Overtured Limb*: an overtured limb is a limb of a fold that has been rotated past the vertical during deformation. To put such a limb back to its unfolded position it must sweep past the vertical.

6. *Interlimb Angle*: the angle between the fold limbs measured within the plane perpendicular to the hinge line. This angle is always in the range 0 to 180° and, therefore, can be either acute or obtuse. The interlimb angle of a fold is always cut by the axial plane, and, in the case of a kink or chevron fold, will bisect the interlimb angle.

7. *Axial Trace*: the axial trace of a fold is simply the strike of the axial plane. The axial trace of a fold can always be measured from a geologic map if the map is relatively flat. In that case, the axial trace is simply the line on the map that connects points of maximum curvature between folded contacts.

### III. Finding Paleocurrent Direction from Crossbed Data.

a) The bearing of the true dip of *crossbedding* indicates the *paleocurrent* direction when the bed was deposited. If stratigraphy containing crossbeds has been tilted from folding or faulting one can "undo" the deformation by rotating the *primary bedding* back to its original horizontal position. In this undeformed position the true dip direction of the *foreset beds* is the paleocurrent direction.

b) Note that a simple one-step rotation to "undo" deformation is only applicable if the kinematic model for deformation indicated that the tilting of strata was done by rotation about a horizontal axis. It is appropriate to unfold the limb of a fold in this manner only if the plunge of the hinge is 0°.

c) Steps for finding the paleocurrent direction:

1. Plot primary (topset / bottomset) bedding as a great circle on the net. Plot the crossbed (foreset) attitude as a pole since it is this entity that we wish to track through a rotation.

2. Move the strike line of primary bedding great circle to the N-S position and visually imagine the rotation necessary about the horizontal N-S axis to move this plane to the horizontal. This angle is always equal to the true dip angle of primary bedding.

3. Move the pole to crossbedding along whatever small circle that it falls upon, the same number of degrees and in the same rotational sense as in step 2. At this position, the pole represents the attitude of the perpendicular to crossbedding before deformation.
4. The paleocurrent direction is the bearing of the true dip of the plane represented by the new pole position. This bearing is always  $180^\circ$  to the bearing of the rotated pole position.
5. If, during rotation of the pole, the primitive is encountered remember that the pole reflects to the diametrically opposed position on the net.

d) Example:

1. Given primary bedding of N-S, 35E, find the paleocurrent directions from crossbed attitudes (1) N69E, 44 SE and (2) N28E, 80NW.

Note: the pole to N69E,44SE is N21W (339), 46, and the pole to N28E,80NW is S62E (118), 10. Because you are rotating the pole instead of the great circle, it saves time to make the mental conversion and just plot the pole. The below rules accomplish the task:

1. The bearing quadrant of the pole is always the opposed quadrant (180 degrees) from the dip quadrant. The quadrant bearing angle is the complimentary angle to the strike quadrant angle.
2. The plunge angle is always the complimentary angle of the true dip angle.

Manual Solution Steps

1. In crossbedding paleocurrent problems the primary bedding attitude should be plotted as a great circle and the crossbedding attitude should be plotted as a pole. Do this as a first step labeling the pole to the crossbedding as "P".
2. The rotation needed to retro-deform the bedding back to its original horizontal attitude occurs about the strike of the primary bedding, and equals the true dip angle.
3. To find the retro-deformed position of the pole (P') move the strike line of the primary bedding great circle to the north position. Imagine the sense of the rotation needed to rotate the primary bedding to the horizontal. Find the small circle that P falls upon. Move it in the same sense and angular amount (true dip angle) along the small circle. This is the P' position. Note that during the rotation if the small circle path encounters the primitive you must continue on the diametrically opposed small circle.
4. To determine the depositional attitude of the crossbedding convert the P' pole to its

strike and dip equivalent. The paleocurrent direction is in the true dip bearing of this planar attitude.

### NETPROG Solution Steps

1. Plot the primary bedding as a great circle, and the two crossbeds as poles "P1" and "P2" respectively. An easy way to plot the poles from the given strike and dip is to use the "Draw" > "Great Circle" menu dialog and manually type in the strike and dip to construct the planar great circle. In addition to the great circle arc NETPROG also draws the selection handle "blip" at the pole to the plane. Use the "Edit" > "Selection Mode" menu dialog to turn on object snap. Any left-click near the pole "blip" will snap to the exact pole point to set the draw anchor. Use the "Draw" > "Marker" dialog with the default anchor to plot the pole "P1". Use the same method to plot "P2".

2. Draw the rotation axis with "Draw" > "Marker" and manually type in the attitude as "N 0 E 0". Set the label to "R". You can now use the "Solve" > "Project by Rotation" to construct the retro-deformed position of the two poles. Pre-select the anchor points with object snap on by left-clicking on or near the "R" point, and then the "P1". Then use the "Solve" > "Project by Rotation" with the rotation angle of +35 (i.e. true dip). This new point should be labeled "P1'". Use the same methods to construct "P2'". Snap to "P1'" and then use "Draw" > "Great Circle" to draw the depositional attitude of the (1) crossbed (red). Use the same method for crossbed (2) (green). The rotated positions are:

$$P1' = N17.8E (17.8), 47.1$$

$$P2' = N60.3W (299.7), 20.9$$

3. Use the "Draw" > "General Arc" to construct the rotation path of each pole. For the (1) crossbed the axis attitude, start attitude, and rotation angle should be the "R" point, "P1"

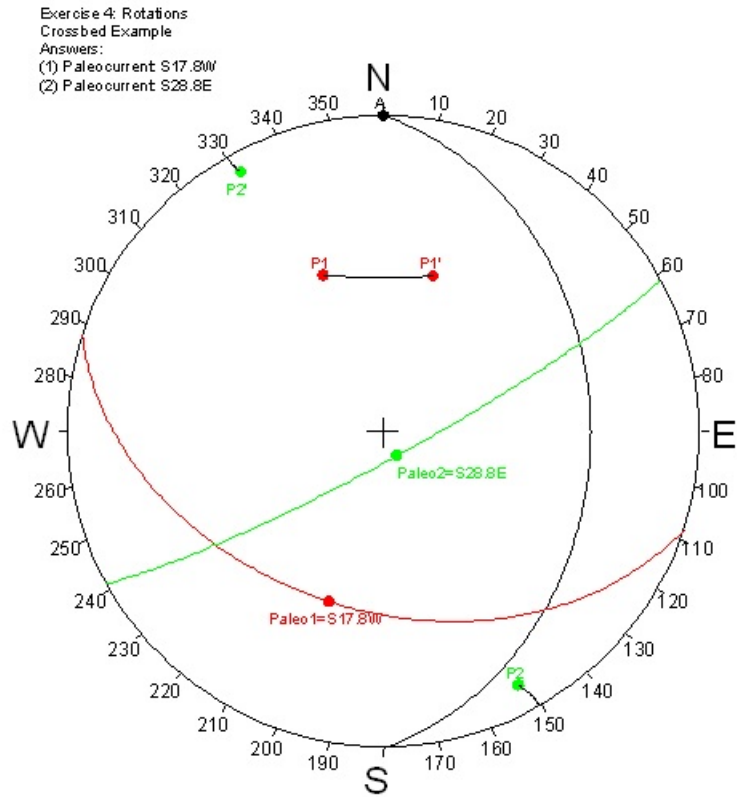


Figure 4-1 : Example crossbedding paleocurrent problem.

point, and +35 degrees respectively. For crossbed (2) use axis point “A”, start attitude point “P2”, and a rotation angle of +35 degrees.

4. Note that the paleocurrent directions are the two crossbed retro-deformed true dip bearings:

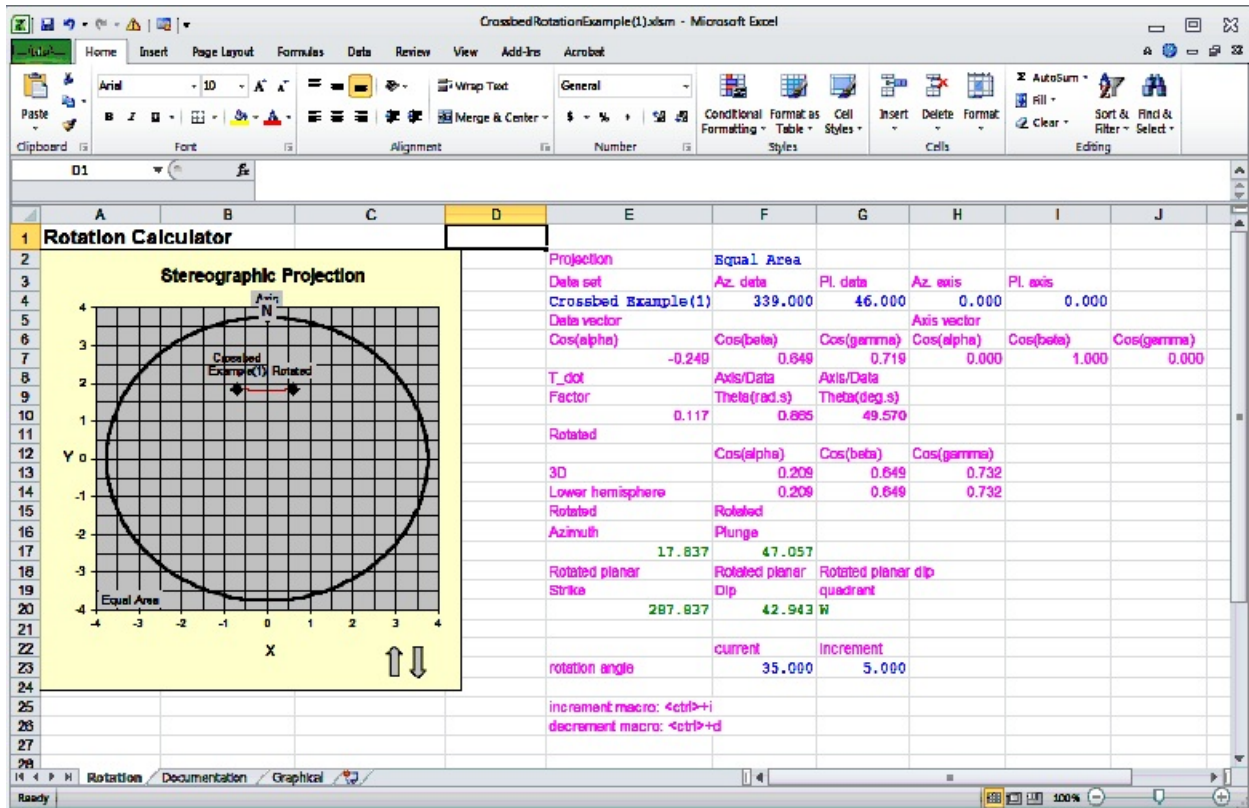
(1) S 17.8 W (197.8)

(2) S 60.2 E (119.8)

Note that a red and green dot are plotted and labeled on the true dip “paleocurrent” directions in **Figure 4-1**.

### Spreadsheet Solution

For the spreadsheet solution the rotation axis = 000, 0; amount sense of rotation is +35° (counterclockwise). The pole to (1) crossbed = 339, 46; (2) crossbed = 118, 10.



**Figure 4-2** : Crossbed example 1 rotation with Excel “rotation.xslm”.

The rotated pole for crossbed (1) = 017.8, 47.1, therefore the down-dip paleocurrent direction is 197.8°. The rotated pole for crossbed (2) = 299.7, 20.9, therefore the down-dip paleocurrent direction is 119.7. See **Figures 4-2** and **Figure 4-3**.

#### IV. Unfolding a plunging fold to find the original attitude of a lineation.

a) These types of problems always involve the determination of the bearing of a lineation before its attitude was changed by a later phase of folding. The solution involves unfolding the fold limbs about the hinge line of the fold until both limbs are coplanar. Then, as a last step, the unfolded plane is brought to the horizontal if the lineation is a primary sedimentary feature. As the limb attitudes are rotated, any lineation that is contained in a limb is moved with the limb, the angle that it makes with the hinge always being preserved.

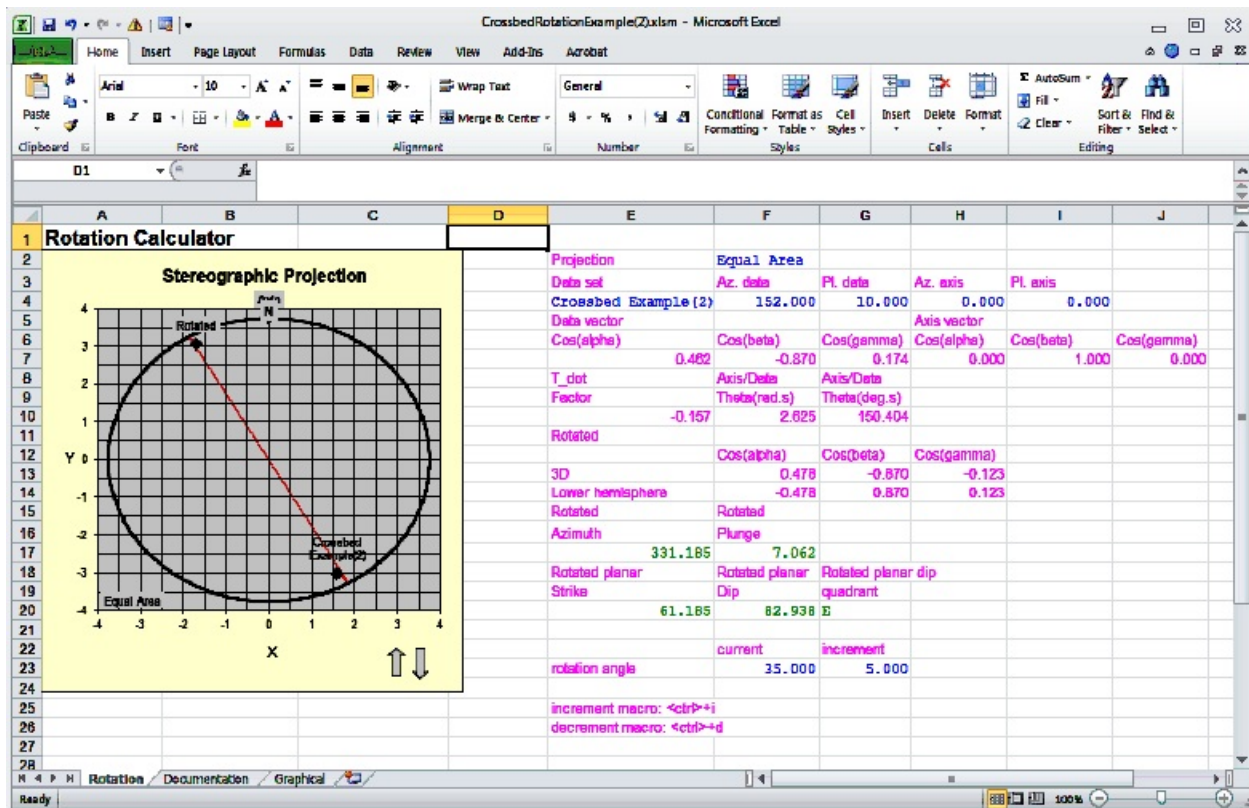


Figure 4-3 : Crossbed example 2 rotation with Excel “rotation.xlsm”.

b) At this point it helps to visualize the elements of the problem. If two limb attitudes are plotted, they intersect at the hinge of the fold. Move the hinge line to the E-W line of the net. If both limbs could be rotated such that they merged with the great circle that runs through the hinge point, you would have "unfolded" the fold. If one of the limbs sweeps past the vertical it must be an overturned limb. The axial plane is simply the great circle plane that contains the hinge point and the axial trace point. The axial trace is the strike of

the axial plane so it always plots on the primitive (i.e. the plunge of the axial trace line is 0). It is helpful to plot the axial plane great circle when visualizing the unfolding process because each limb must move away from the axial plane as it rotates towards the unfolded plane. The interlimb angle can be visualized as the angle that would form when both limb great circles intersect the fold profile plane (i.e. the plane perpendicular to the hinge). The axial plane great circle always bisects the interlimb angle measured along the fold profile.

c) Steps of the problem:

1. Plot one or both limbs and the hinge of the fold, depending on the specific problem. You must know the hinge attitude before continuing.
2. Plot the lineation that will be rotated as a point. The lineation will always fall on one of the limb great circles. The limbs, by definition, also intersect at the hinge of the fold.
3. Move the tracing paper so that the limb containing the lineation falls on a great circle. Measure the angle between the lineation and the hinge line of the fold. This angle must be preserved through any subsequent rotation steps.
4. Now move the hinge line to the E-W line. Imagine how the limb containing the lineation moves to the "unfolded" position. This is the great circle that passes through the hinge line. Plot the rotated position of the lineation by counting the angle between the hinge line and lineation measured in step (3) above. Plot the new position of the unfolded sole mark by measuring the same angle from the hinge along the unfolded plane. Note that there are always two possible directions to measure the angle from the hinge so you must be sure you have correctly visualized where the sole mark moves during the unfolding process.
5. If the lineation is a primary sedimentary structure it must be rotated to the horizontal. Move the great circle representing the unfolded fold to the primitive through its true dip angle. The lineation will track along a small circle until it encounters the primitive. The bearing of the lineation at this position is the answer. If this is a sole mark remember that the reverse bearing is also a possible paleocurrent direction.
6. If you are given an axial trace attitude you can determine the axial plane attitude by finding the great circle that passes through the hinge and axial trace points.
7. If you are asked to determine the interlimb angle you must plot the fold profile plane great circle. This is always the great circle that is perpendicular to the hinge

of the fold. The correct interlimb angle will be the angular arc measured along the fold profile plane between the limbs that is bisected by the axial plane.

d) Example problem- given two limb attitudes (1) N72W, 40NE and (2) N70E, 80NW, the axial trace (N80E) of the fold from a geologic map, and a *sole mark* that trends N0E on the overturned limb, find:

1. The hinge attitude. (30, N64E)
2. The original bearing of sole marks. The sole marks currently trend along a bearing of N0E in the overturned limb. (S60E-N60W)
3. The attitude of the axial plane. (N80E, 65NW)
4. The interlimb angle of the fold. (51)

Remember that a sole mark is a primary sedimentary structure that has a linear geometry, therefore, it should have an original plunge angle of 0 and its bearing should be parallel to the paleocurrent direction.

#### Manual Stereonet Solution

1. Plot the 2 limb attitudes as great circles. The intersection of the great circles is the hinge of the fold. (N64E, 30)
2. Draw the axial trace as a marker labeled "AT". Rotate the overlay so that this point and the hinge point can be aligned along a unique great circle to construct the axial plane (N80E, 65NW).
3. The sole mark is on the overturned limb so you must identify which of the limbs is overturned. Rotate the hinge to the East-West line of the stereonet. Whatever great circle the hinge falls on is the "unfolded" plane. Trace this great circle on the overlay.
4. Now imagine the path that each limb would follow as they are rotated around the hinge point to merge with the unfolded plane. Remember that the limbs cannot pass through each other, and that they must each move away from the axial plane and toward the unfolded plane. The limb that must pass through the vertical (center of the stereonet) must be the overturned limb. The point on this limb that trends N0E is the present attitude of the sole mark. Measure the angular arc between this sole mark and the hinge point in the overturned limb.
5. Align the unfolded plane with its matching great circle on the stereonet grid. Imagine the path that the sole mark would travel along if the overturned limb merged with the unfolded plane. Using the angle measured between the sole mark and hinge in (3), measure this same angle from the hinge along the unfolded plane in the direction indicated by the unfolded path. This is the new position of the sole mark.
6. The unfolded plane must now be rotated to the horizontal. Move the strike line of the unfolded plane to the stereonet grid north. Trace the small circle path of the sole mark to

the primitive. This is the depositional attitude of the sole mark (S61E and N61W).

7. To solve for the interlimb angle you need to draw the great circle 90 degrees to the hinge- known as the fold profile plane. Note the position of the points on this plane created by the intersection of the two limbs. The interlimb angle is the arc of the great circle bisected by the axial plane (51).

#### NETPROG Stereonet Solution

1. Use the “Draw” > “Great Circle” to draw the 2 limbs as great circles. Select both limbs and use the “Solve” > “Intersecting Planes” to calculate the hinge attitude. This point is labeled as “Hinge” in **Figure 4-4**.

2. Next plot the “unfolded plane” that results from rotating both limbs into a single plane. This plane will have the hinge point as the down-dip linear vector.

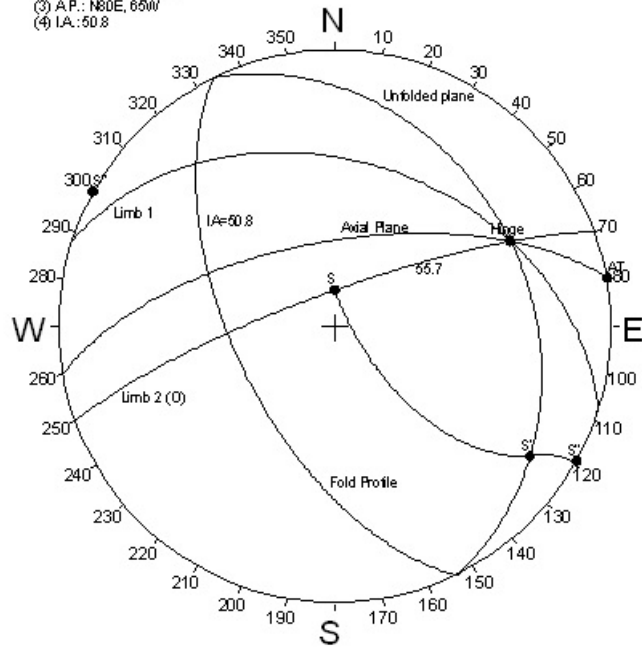
Highlight the “Hinge” point with a right-click, and then double-click on the highlighted point to determine the attitude of the hinge point (N 64.1 E 30.2). The strike of the unfolded plane will be the north quadrant bearing 90 degrees to this bearing (N 25.9 W). The true dip is the same as the plunge (30.2 E). Use the “Draw” > “Great Circle” menu to plot the unfolded plane attitude of N 25.9 E 30.2 E and label the unfolded plane (see **Figure 4-4**).

3. At this point plot the axial plane to help decide if a limb is overturned. The axial plane must pass through the hinge and axial trace points. Use the “Draw” > “Marker” menu selection to draw the axial trace point at N 80 E 0 and label it as “AT”. Use 2 right-clicks to select the hinge and axial trace points (“Hinge” and “AT”), and then use “Solve” > “Common plane” to plot the Axial Plane great circle (see **Figure 4-4**). Label the axial plane great circle as “Axial Plane”.

4. Observe the diagram. Note that during the “unfolding” of the two limbs they both must rotate around the hinge point and move away from the axial plane until “merging” with the unfolded plane. The overturned limb is the limb that passes through the vertical (i.e. center of stereonet) during this process. Label the limbs as “Limb 1” and “Limb 2” with a following “(O)” on the overturned limb (Limb 2). The sole mark trends N0E in the overturned limb, therefore, the most exact way to fix this point is to draw a vertical great circle with attitude of N 0 E 90 E, and then intersect this great circle with the overturned limb great circle using the “Solve” > “Intersecting Planes” menu item. Erase the vertical plane after solving, and label the sole mark position as “S”.

5. With two right-clicks select the “S” and “Hinge” points and then use the “Solve” > “Angle between Points” option to determine the angle between the hinge and sole mark lineation

Exercise 4: Rotations  
Example Fold Unfolding Problem  
Answers:  
(1) Hinge: N64E, 30  
(2) Paleo.: S61E-N61W  
(3) A.P.: N80E, 65W  
(4) I.A.: 50.8



**Figure 4-4** : Example unfolding fold problem.

(55.7). This angle is maintained during the unfolding rotation, therefore, the position of the sole mark will be at the location measured from the hinge point along the unfolded plane at this same angular distance (55.7). The direction from the hinge is deduced by imagining the path that “S” would move along as the overturned limb is unfolded. You should be able to verify that the unfolded position of the sole mark (S’) will be in the southeast quadrant of the stereonet on the unfolded plane. To plot the S’ position use two right-clicks to select the unfolded plane and then the hinge point. Use the “Solve” > “Project by Angle in Plane” option to project the S’ point at a specific angle from the hinge in the unfolded plane. The angle should be -55.7 because the S’ point is clockwise from the hinge point in the unfolded plane. Select the new marker and double left-click to add the label “S”.

6. A small circle arc can be constructed to display the path of “S” as it is rotated to “S” as the fold is unfolded. This path is a small circle arc with an axis at the hinge, start point at “S”, and ending point at “S’”. Turn on the object snap mode via the “Edit” > “Selection Mode” dialog. When the object snap mode is on a left click will set a “blip” (small black cross) at the mouse pointer position, but if the left-click is within a certain threshold distance to an existing annotation geometry a larger red cross will appear on this object. The coordinates used for the anchors, and therefore in later draw operations, will be set by the red cross position. In this way you can snap exactly to previously drawn annotation elements. In sequence left-click on or close to the hinge, “S”, and “S’” points to set three anchor positions. Select the “Draw” > “Small Circle Arc” menu item. The dialog will automatically use the hinge, “S”, and “S’” positions as the axis, start, and end points of a small circle arc. The resulting small circle arc should connect the “S” to “S’” points.

7. To finish retro-deforming the sole mark to its depositional attitude the dip must be removed from the unfolded plane by rotating around the strike of the plane. Therefore the axis would be N 25.9 W 0, with a rotation of +30.2. Use the “Solve” > “Project by Rotation” to construct the “S’” point, and “Draw” > “Small Circle Arc” to construct the 2<sup>nd</sup>-step rotation path. See **Figure 4-4** for the results (S’ paleocurrent = S 60.9 E 0.0 or N 60.9 W 0.0).

8. To determine the interlimb angle you must draw the plane perpendicular to the hinge (Fold Profile). Do this by snapping to the hinge point and then selecting “Draw” > “Great Circle”. Label the fold profile plane, then select the fold profile and limb 1 planes and then draw the intersection point with “Solve” > “Intersecting Planes”. Do the same for Limb 2 and the fold profile. The angle between these two points is the interlimb angle (50.8).

## V. Rotational fault problems.

- a) A *rotational fault* has displacement that is characterized by motion of one fault block relative to another about a *rotational axis* perpendicular to the fault surface. Usually the problem will ask you to predict the attitude of a planar structure, such as bedding, after some amount of rotation within one block.
- b) The rotational axis must always be perpendicular to the fault surface, therefore, if you are given the attitude of the fault you can then plot the rotational axis as the pole to the fault.

c) Since you are to rotate a planar structure in one of the fault blocks, you must plot this structure as a pole.

d) Before actually plotting the solution on the net, make sure that you are clear about the sense of the rotation. Usually the problem specifies a specific orientation in which to visualize the rotations, such as "... as viewed from the southeast looking northwest the motion of the southeast fault block is clockwise".

e) Problem solution steps:

1. Plot fault surface as a great circle. Plot rotational axis as pole to the fault surface. Label rotational axis point with an "R" for reference.

2. Plot the pole to bedding. Label this as point "P".

3. Plot the great circle that contains both "R" and "P", but only between the points "R" and where the great circle intersects the fault. Label the intersection point with the fault as point "L".

4. While visualizing the sense of rotation, move point "L" along the fault surface the amount of the rotation. Label this new point as point "L prime".

5. Plot the great circle that contains both "R" and "L prime". While maintaining the original angle between "R" and "P", plot the "P prime" position along the great circle containing "R" and "L prime". Be careful when plotting this position since it is always possible to count the angle from "R" in two directions- only one position will be correct.

6. The "P prime" position represents the rotated position of the pole to the planar structure. The answer is the attitude of the plane represented by "P prime".

f) Example problem: given a planar fault N30E, 60SE; bedding within the northwest fault block N90E, 40S (pole = N0E, 50); and that the southeast block has been rotated 120 degrees anticlockwise as viewed in the bearing direction of the rotational axis, find the rotated attitude of bedding in the southeast block.

#### Manual Solution Method

1. Plot the planar fault attitude as a great circle. Label the great circle with "Fault". Plot the pole to this plane and label it as "R" for the rotation axis.

2. Plot the pole to the bedding as a "P" point. Plot the great circle arc that extends from "R" to "P" to the fault plane great circle. Where the arc intersects the fault label the point

as “L”. Measure the angle between “R” and “P” in the arc and label that portion of the arc with the angle value.

3. During rotation of the fault the angular relationship between “R” and “P” and “L” remains constant. Although you can’t directly trace the path of “P” during rotation because of the plunge of the rotation axis, you can track the rotation of “L” because it is perpendicular to “R” and travels along the fault plane great circle during rotation. If you can determine where the new position of “L” is located after rotation, you can also find the new position of “P”.

4. Visualize the rotation of “L” around the “R” rotation axis. Mark off the rotation angle from “L” to “L’” being careful to take into account the sense of rotation. To measure the angle between “L” and “L’” you need to have the fault plane aligned with a great circle on the stereonet. Use the crossing small circle grid lines to mark off the degrees.

5. When “L’” is determined, trace the full great circle that passes through “L’” and “R”. This is the plane that contains “R” and “L’” after rotation, therefore, “P’” must lie in this plane at the same angle from “R” that was measured in step (2). Unfortunately there are always two possible directions to measure and plot “P’” relative to “R”.

6. To determine the correct “P’” position from the two possibilities, carefully visualize the path of “P” as it rotates around “R” and moves to “P’”. Remember that if the path encounters the primitive the path will “reflect” to the diametrically opposed position on the stereonet.

7. Once the correct position of the “P’” rotated pole is determined (see **Figure 4-5**), the new pole should be converted to a strike and dip for the answer (N 40 E 72 W).

#### NETPROG Solution Method

1. Plot the fault surface (N30E, 60SE) as a great circle with the “Draw” > “Great Circle” menu command. The rotational axis is the pole to this plane, so turn on the object snap mode, and left-click near the pole blip mark to snap to the pole attitude. Use the “Draw” > “Marker” to draw a marker at this position. Label this rotational axis marker “R”.

2. To plot the pole to the bedding, first plot the bedding great circle (N90E, 40E), turn on the snap mode, and then snap to the pole position and use “Draw” > “Marker” to plot the pole. Label the pole marker “P”.

3. Select the “P” and “R” marker points with right-clicks, and then use the “Solve” > “Common Plane” to construct the great circle plane that contains those two points. Leaving those two points selected, use “Solve” > “Angle between lines” to calculate the angle between “R” and “P”. Label the arc of the great circle between “R” and “P” with

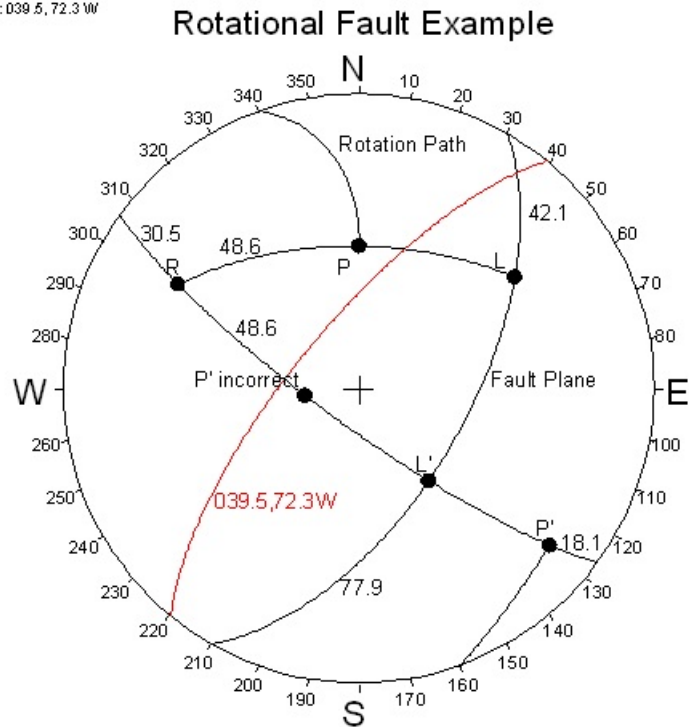
this angle (48.6). Unselect the “P” and “R” points.

4. Select the fault plane and the plane constructed in (3) by right-clicking on the pole handles (small crosses). Use “Solve” > “Intersecting Planes” to construct the marker point at the intersection of these two great circles. Select and edit this new marker and label it “L” (see **Figure 4-5**).

5. Select the great circle that passes through “R”, “P”, and “L”. Use the “Edit” > “Delete Selected” in the Annotation child window to delete the great circle. You want to show just the great circle arc that passes through “R”, “P”, and “L”, so turn on the object snap and left-click close to “L” and then “R”. Use the “Draw” > “Great Circle Arc” to construct the arc. The default attitudes will work if the snap to “L” and “R” work correctly.

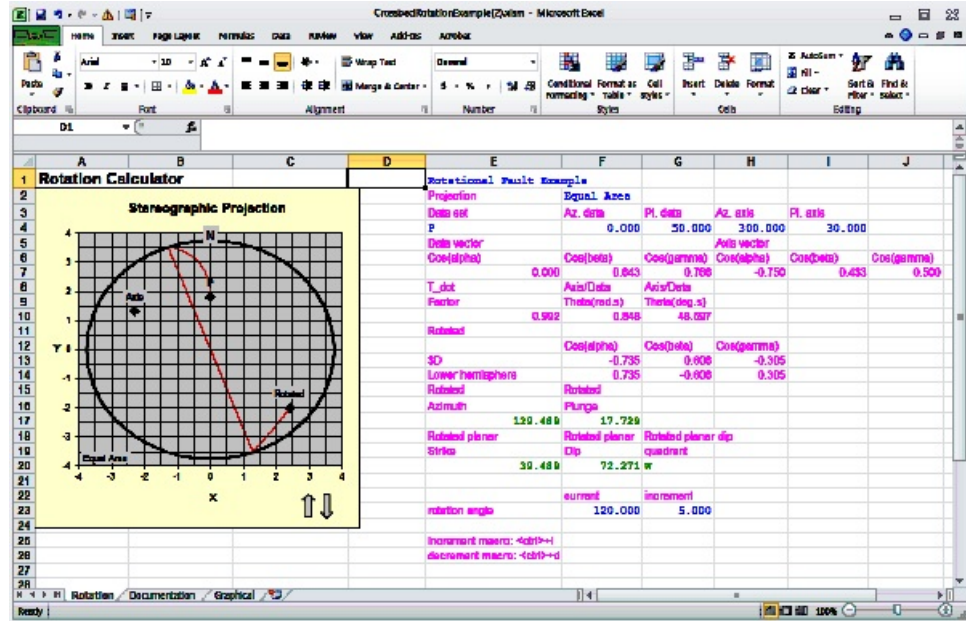
6. You now need to visualize the 120 degree rotation of “L” around “R”. Remember that as viewed down-plunge of the “R” axis, a positive rotation is counterclockwise as specified by the problem. During rotation the “L” point would therefore move northeast along the fault plane great circle until it encounters the primitive, at which point it would jump to the diametrically opposed end of the great circle and continue northeast to point “L’” in **Figure 4-5** for the full 120 degrees. Select in order with right-clicks the “R” and “L” marker points. Use the “Solve” > “Project by Rotation” menu item. The rotation axis should be set to the “R” attitude, and the start point should be the “L” attitude. Type in “120” for the rotation amount. This will construct the “L’” marker point. Edit and label it “L’”.

Exercise 4  
Rotational Fault Example  
Answer: 039.5, 72.3 W



**Figure 4-5** : Rotational fault example.

7. The correct position for “P”, the rotated pole to bedding, lies 48.6 degrees from “R” on the great circle that passes through “L” and “R”. Select these two points with right-clicks and then use “Solve” > “Common Plane” to construct this great circle.



**Figure 4-6** : Example rotational fault problem solution using “rotation.xlsx”.

8. You now need to visualize the rotation of “P” around “R” to the new “P” position. Note that are two directions along which you can mark off 48.6 degrees from “R” along the “R” - “L” great circle. Convince yourself why “P” in **Figure 4-5** is correct. This point can be constructed by projecting from “R” along the “R” - “L” plane by -48.6 (clockwise) rotation angle. Select the “R”-“L” great circle, and then “R” with right-clicks, and then use “Solve” > “Project by Angle” to construct “P”. Edit and label the new marker point “P”. This is the rotated bedding pole- convert this to a strike and dip for the answer (N 39.5 E 72.3 W).

9. To prove that you solved the problem correctly, and to show the rotation path of “P” as it moves to “P” you can use “R” and “P” as the axis and start point of a small circle arc. Turn on object snap and left-click near “R” and then near “P”. Use “Draw” > “General Arc” to open the dialog window. The axis and start point should be pre-filled with the “R” and “P” attitudes. Type in 120 for the rotation angle. The small circle arc should start at “P” and extend to “P” as in **Figure 4-5**.

Spreadsheet Solution: the “Rotation.xlsx” spreadsheet can be utilized to solve the rotational fault problem. **Figure 4-6** Contains the solution that corresponds to the above example problem.

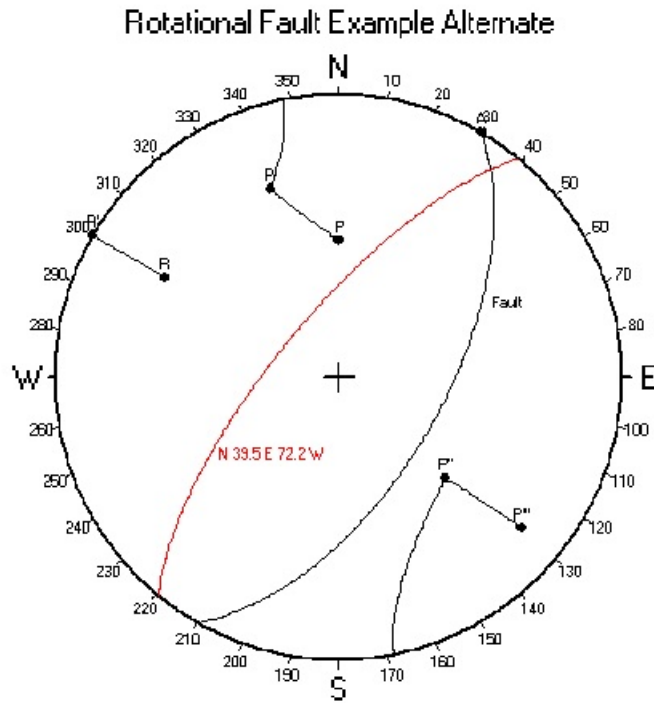
Alternative Manual Solution Method: this method requires more steps but allows you to

use the small circles on the stereonet to trace the movement of the pole in each step. This leaves less room for error relative to “seeing” the sense of rotation in 3D. However, you are more likely to have an error because you forget one of the “steps” in the multi-step process.

1. Plot the fault attitude as a great circle. Label the great circle with “Fault”. Plot the pole to this plane and label it as “R” for the rotation axis. Plot the pole to the bedding as a “P” point.

2. Note that the small circles on the stereonet are produced by rotating lines about a horizontal N-S axis. To use these small circles to track the rotation you need to remove the plunge from the rotation axis “R”. Move R to the east-west line of the stereonet and trace the shortest path along the line to the primitive. Count the angle (i.e. it is always the plunge of R), and label the new point on the primitive as R’. Move P along whatever small circle it falls on the same amount and sense of the angle. Label this new point P’. See the paths R-R’ and P-P’ in **Figure 4-7**.

3. Move R’ to the North position of the stereonet. Rotate P’ around R’ by 120 degrees anticlockwise as described in the problem. P’ will track along a stereonet small circle to P’’. If the rotation path encounters the primitive remember to project through the center of the stereonet to the diametrically opposed small circle and continue. Always trace the rotation path so you can check the results later. (See the path P’ to P’’ in **Figure 4-7**).



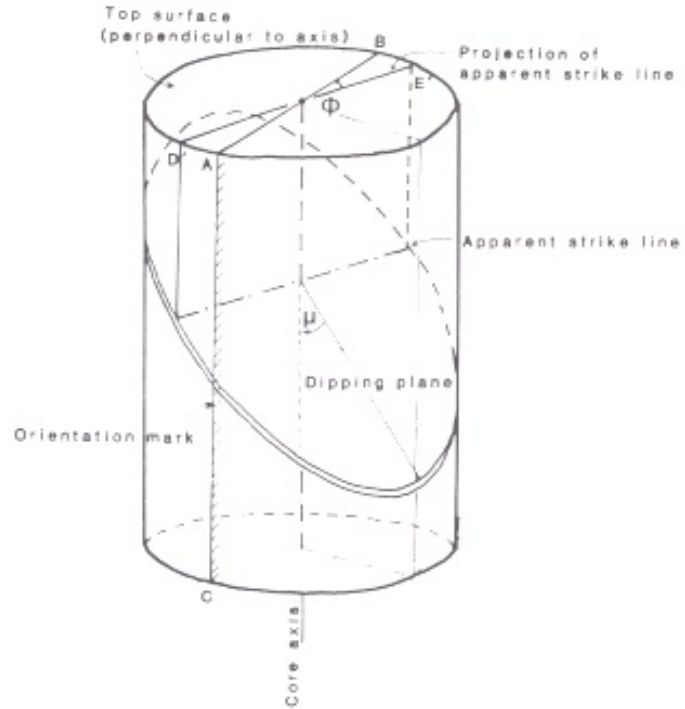
**Figure 4-7** : Alternative manual rotational fault example.

4. Now you must add the original plunge back to R’ and move P’’ accordingly. Move R’ back to the East point of the stereonet and find the small circle P’’ falls upon. Imagine the sense of rotation needed to move R’ back to the original R position. Move P’’ in the same

angular sense and magnitude along a small circle to P''. This is the rotated position of the pole to bedding. Convert this to a strike and dip for the answer (N39.5E, 72.2W).

## VI. Drill Core Rotational Problems

a) Drill cores are rarely if ever perfectly vertical, therefore, if an oriented core is taken (as is usually the case) an index mark will record the plunge and bearing of the core. If the trace of planar bedding is visible in the core, the "apparent" strike and true dip could theoretically be measured by standing the core up vertically, rotating the index mark toward the bearing



**Figure 4-8** : Example Drill Core problem.

of the core, and measuring the apparent bedding orientation with a pocket transit. Unfortunately, an actual drill core is usually much too long and heavy to stand up and rotate. Therefore, what is usually done is the angle that the apparent strike makes with the bearing mark ( $\phi$  in **Figure 4-8**) of the core is measured, and the inclination that the apparent bedding plane makes with the core axis is measured ( $\mu$  in **Figure 4-8**). These angles are then used to calculate a "relative" strike and dip. For the **Figure 4-8** example the relative apparent strike and dip would be reported as N20E, 70SE because  $\phi$  was measured 20 degrees clockwise from the line AB (bearing trace of index mark), and the 20 degree  $\mu$  angle was measured from the dipping plane toward the vertical axis of the core, an angular direction that is clockwise as viewed toward the B end of the index line. Note that positive  $\mu$  angles always plot on the "right-hand" side of D'E', so the relative inclination is  $90-\mu = 70\text{SE}$ . If the  $\mu$  angle had been -20 the dip direction would have been 70NW. When the elements of the problem are plotted on the stereonet the apparent strike and dip are plotted by first plotting the vertical plane that contains the actual plunge and bearing of the core axis. Because the example core axis bearing is 40, 220, this vertical plane is 040, 90. This plane should then be rotated to the North position, and then the "N20E, 70SE" great circle should be plotted relative to this mark, and then labeled D'E' on the stereonet. Note that the E' end of the D'E' line is the north quadrant end.

The apparent strike and dip should then be plotted as a pole (P). The plunge and bearing of the drill core is then plotted as a lineation point (DC'), and this point is rotated from the vertical about a horizontal rotation axis oriented perpendicular to the core bearing by

an amount necessary to move the drill core point to the actual core attitude (DC'). The pole to the apparent strike and dip plane is rotated in the same manner to the pole to the true strike and dip (P'). The attitude of bedding is extracted from the rotated pole.

B) Example Problem: Given a drill core with orientation marks indicating a drilling attitude of 40, 220, and  $\phi=+20$  (clockwise or NE quadrant) and  $\mu=+20$  (right-hand side or SE dip quadrant), find the actual "real-world" attitude of the bedding in the core.

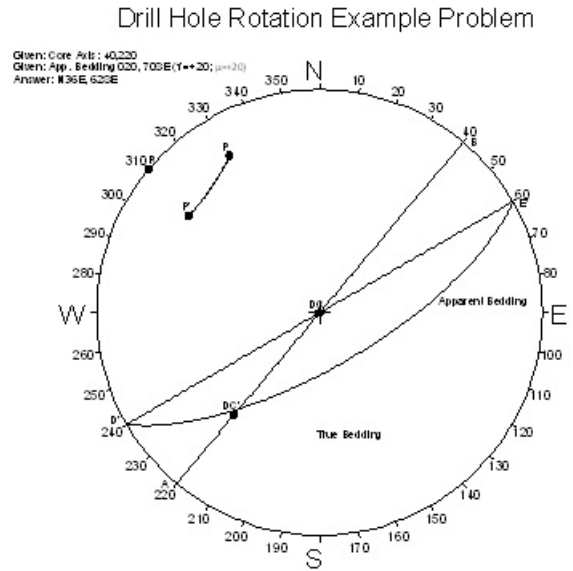
Stereonet Solution (Figure 4-8 and 4-9):

Step 1: Plot the core axis attitude used to measure the apparent strike and dip as point DC (vertical) and the actual attitude of the core (40, 220) as point DC'. Plot the vertical plane that contains the core axis and label the ends as AB as in **Figure 4-9**. Rotate the AB plane to the North reference, and then draw in the great circle that would be N20E, 70SE "relative" to AB. This plane is N60E, 70SE in real-world orientation. Label the ends of this great circle as D'E' as in **Figure 4-9**, and the interior of the great circle as "Apparent Bedding". Plot the pole to this attitude as point "P".

Step 2: Determine the orientation of the rotation axis that is the horizontal line perpendicular to the bearing of the core axis. In this example this is azimuth is  $220+90 = 310$  (but it could also be 130) and is labeled "R".

Step 3: Visualize the rotation of point DC to DC' about the point R rotation axis. The amount of rotation is 50 degrees (i.e. 90-plunge), and the sense of rotation as viewed from the center of the stereonet toward point R is clockwise. Note that if the rotation axis had been 0, 130 the sense of rotation would have been counterclockwise instead. Move point "R" to the North point and mark off the small circle arc starting at P and moving clockwise 50 degrees about "R". At the end of the arc plot point P' (**Figure 4-9**). As a check use the same method to trace the small circle arc starting at DC and moving clockwise. The end of this arc should correspond to the location of DC' (i.e. the given attitude of the core axis 40,220).

Step 4: Plot the great circle 90 degrees from the P' point and then measure the strike and dip of this great circle. This is the actual "Real-World" attitude true strike and dip (N36E, 62SE) of the bedding in the core.



**Figure 4-9** : Example drill core problem stereonet.

#### EXERCISE 4A: Rotations with the Stereonet

This laboratory exercise will test your knowledge of rotation operations with the equal-area stereonet. Use a 3.5 inch radius equal area stereonet to solve the below problems.

Problem 1: Given a mineral lineation attitude of  $030, 60$ , and a rotational axis attitude of  $000, 0$ , find the new attitude of the mineral lineation after rotations of:  $90, 180, 270, 360$  degrees. Label the original and rotated attitudes as  $L1(90), L1(180), L1(270)$ , and  $L1(360)$  respectively. Label the rotation axis "R1". As part of the answer list the linear attitudes for  $L1(90), L1(180)$ , and  $L1(270)$ . Also list the angle measured between R1 and  $L1(0)$ . Draw in the small circle that passes through all of the L1 points.

Also plot a mineral lineation attitude at  $160, 33$ , and label it " $L2(0)$ ". Plot a marker at  $056, 21$ , and label this rotation axis as "R2". Rotate L2 around R2 for the following angular amounts:  $-45, -90, -120$ . Label these new linear attitudes  $L2(-45), L2(-90)$  and  $L2(-120)$  respectively. List the attitudes of  $L2(-45), L2(-90)$  and  $L2(-120)$  as part of your answer. Also calculate the angle between R2 and  $L2(0)$ . Draw in the "small circle" that passes through all of the L2 points.

Problem 2. A planar limb of a fold ( $053^\circ, 50^\circ\text{SE}$ ) contains a crossbed with orientation  $022^\circ, 72^\circ\text{NW}$ . Assuming that the plunge of the fold hinge is  $0^\circ$ , find the original orientation of the crossbed, and the trend of the paleocurrent.

Problem 3. Given the axis of a rotational fault ( $42^\circ, \text{S}48^\circ\text{E}$ ), bedding orientation ( $\text{N}37^\circ\text{W}, 66^\circ\text{SW}$ ) in the undeformed southeast fault block, and that the northwest fault block was rotated  $70^\circ$  clockwise (as viewed down-plunge) about the fault rotational axis, find the rotated attitude of bedding in the northwest fault block.

Problem 4. Given two planar limbs of a syncline ( $\text{N}8^\circ\text{E}, 56^\circ\text{SE}$  and  $\text{N}32^\circ\text{W}, 80^\circ\text{NE}$ ), find the orientation of the fold axis. If there is presently a  $\text{N}90^\circ\text{E}$  bearing ripple-mark lineation on the overturned limb, find the original bearing of this lineation, assuming that it was originally horizontal. How many degrees must the overturned limb be rotated about the fold axis to "unfold" this fold?

Problem 5. The planar limbs of an upright chevron fold (axial plane dip  $> 45^\circ$ ) have the following attitude:

1.  $023^\circ, 57^\circ\text{SE}$
2.  $348^\circ, 71^\circ\text{SW}$

With this data, and assuming that the axial plane bisects the interlimb angle, find:

- (a) Plunge and bearing of the fold hinge.
- (b) Interlimb angle of the fold.

(c) Axial plane attitude of the fold.

Problem 6. An inclined drill core has an orientation mark indicating a plunge and azimuth for the drill core axis of 62, 210. The angles  $\phi = -30$  and  $\mu = +30$  (remember positive angles are clockwise; refer to the **Figure 4-5** diagram) were measured by the drilling engineer. Find the real-world strike and dip attitude of the vein.

## EXERCISE 4B: Rotations with the Stereonet

This laboratory exercise will test your knowledge of rotation operations with the equal-area stereonet. Use a 3.5 inch radius equal area stereonet to solve the below problems.

Problem 1. The limb of a fold (053, 50SE) contains a crossbed with orientation of 022, 72NW. Find (a) the original attitude of the crossbed, and (b) the paleocurrent direction bearing.

Problem 2. Given the axis of a rotational fault (132, 42), and that the SE fault block originally containing bedding (323, 66SW) has rotated about the rotational axis 70 degrees counterclockwise as viewed down-plunge of the rotational axis, find the new attitude of bedding (azimuth strike and dip format).

Problem 3. Given two limbs on a syncline (008, 56SE and 328, 80NE), find (a) the orientation of the fold hinge. If there is an east trending ripple mark lineation on the overturned limb, find (b) the original depositional trend of this primary lineation. How many degrees (c) was the overturned limb rotated about the hinge line to retro-deform the fold?

Problem 4. Given a fault (N90E, 90) and the attitude of bedding in the south fault block of N49E, 42SE, find the attitude of the same bedding in the north block if it has been rotated 150 degrees counterclockwise relative to the south block as viewed toward the north block.

Problem 5. A fold has an axial trace of N44W and a hinge attitude of N30E, 56. What is (a) the axial plane strike and dip (quadrant strike and dip format)? Assuming that the fold is symmetrical and that the interlimb angle is 26 degrees, find (b) the attitude of the two limbs. A flute cast lineation trends N08W on the overturned fold limb. What is (c) the paleocurrent direction indicated by this primary lineation?

Problem 6. An inclined core has a logged attitude of 40, 310. The angles  $\phi = -40$  and  $\mu = -35$  were measured by the drilling engineer (refer to **Figure 4-5**) relative to a bedding contact that cuts across the drill core. Find the attitude of bedding.

## LABORATORY 5: Contoured Stereographic Diagrams

### I. Types of Stereonets

#### a) Equal-angle stereonet

1. Also termed *Wulff* net.

2. Maintains angular relationships within the projection plane of the stereonet. For example, if the small circle intersection of a cone with the lower hemisphere is plotted, on an equal-angle net the shape of this surface will project as a perfect circle.

#### b) Equal-area stereonet

1. Also termed *Schmidt* net.

2. Maintains the proportion of the lower hemisphere surface projected to the plane of the net. In other words, no preferred alignment of data will be apparent if the data are truly random.

c) For the plotting of a large number of structural data elements, we must use the equal area net to remove any bias when interpreting the average trend of the data. For this reason most structural geologists will carry the equal area net with them in the field.

d) Note that the types of problems worked in previous laboratory exercises can be solved with either net. In effect, both nets preserve the angular relationships between lines and planes in three dimensional space, however, when these elements are projected to the two dimensional plane of the net diagram they are somewhat distorted on the equal area stereonet.

e) Be aware that you cannot plot data with one type of net, and then measure angular relationships or rotate data with the other type.

### II. Constructing contoured stereonets.

a) A typical detailed structural analysis of an area will often yield hundreds if not thousands of attitude measurements on a variety of planar and linear structures. This is particularly true of deformed metamorphic terranes that may display several generations of structural elements at a given exposure.

b) If large numbers of data are plotted on a net, the diagram may become overwhelmed by the number of plotted data, making it difficult to interpret for structural trends. In this

case it is necessary to contour the data rather than plot individual points or great circles.

c) The point at which it becomes necessary to contour structural data depends not only on the number of observations, but also on other factors such as the degree of clustering, etc. In practice most geologists contour the data when more than 50-100 data are plotted.

d) Since constructing a contour diagram requires a great deal of repetitive plotting, it is an excellent task for a computer. Although you will initially construct several diagrams by hand to learn the fundamentals, in future labs the actual construction of the diagram will be a task for the computer.

e) Steps for constructing a contoured stereogram

1. Plot all of the data on the stereonet. Planar data should be plotted as poles.
2. Transfer the plot constructed in (1) to the *Kalsbeek counting net*. Use of the counting net will be demonstrated in class.
3. Count the number of points or poles that fall within a given six-sided polygon on the counting net. Write this number at the center point of the polygon. The center point is termed the *counting node point*.
4. Remember to count points near the primitive at the diametrically opposed counting nodes. Note that a given point may be counted up to three separate times.
5. On a separate sheet of paper the count node values are recalculated as a percentage of the total number of data:

$$\text{percentage} = (\text{count node value}) / (\text{total number of points}) \times 100$$

For example, if the total number of data is 233, and a count node tally was 15, its recalculated percentage would be:

$$\begin{aligned}\text{percentage} &= (15)/233 \times 100 \\ \text{percentage} &= 6.4\end{aligned}$$

Usually the percentages are rounded to the nearest whole number. This value represents the percentage of the total data that fell within the one percent area of the lower hemisphere centered around the counting node point.

6. After calculating the percentage values for every node on the counting net, the percentages are contoured as you would contour any other distribution of values.

There are no specific rules for contouring stereograms, however, you should follow the below general guidelines:

- a. Pick a contour interval that produces at least 5 distinct contour levels on the stereogram.
- b. If several types of data are plotted on separate stereograms for comparison, use the same contour interval for each, otherwise, it is not valid to compare structural trends.
- c. Always indicate the contour interval levels below the stereogram.
- d. If poles to planar data are contoured, make sure that this is mentioned in your legend or title on the stereogram.

7. The student should note that if a contour line intersects the primitive, the same contour line should intersect the primitive at the diametrically opposed position on the primitive.

### III. Interpretation of Stereograms

a) The plotting of data on the stereonet has as a goal the determination of structural trend. For example, the attitude of the fold hinge of a large structure may be evident when regional data is plotted.

b) Plotting data on the stereonet may have a purely statistical goal. For example, a geologist may know from experience that bedding in a region generally strikes NE, and generally dips at a moderate angle to the SE, but what is the best single estimate of the average attitude of bedding?

c) Stereograms are used to determine the attitude of these basic structural orientation distributions:

1. *Uniform or Random Distribution*: this distribution proves that there is no preferred orientation of data. This would be represented by points or poles uniformly distributed on the stereonet.

2. *Point maximum*: this is a tight grouping of points about a particular point on the net. If the data plotted is linear, the center of gravity of the point maxima is considered to be the average attitude of linear data. If the data is poles to planes, the center of gravity of the point maximum is  $90^\circ$  from the great circle representing the average attitude of the planar data.

3. *Great circle girdle*: if the plotted points tend to line up along a great circle, the vectors representing the plotted points tend to lie within a plane. If the data plotted are poles to planes, the great circle along which the poles align is  $90^\circ$  from the hinge of the fold.

4. *Small circle girdle*: if plotted points align along a small circle girdle, the vectors that represent the points lie within a conical surface that intersects the lower hemisphere along a small circle.

#### IV. Analysis of Folding with Stereograms

a) There are two fundamental types of fold geometries:

1. *Cylindrical*: produced by moving a line parallel to itself so as to sweep out the surface. This line is termed the fold axis, and is parallel to the hinge of the fold. Cylindrical folds produce great circle girdle distributions when poles to planar structures are plotted on the stereonet.

2. *Conical*: conical fold geometry can be modeled by rotating a line about a rotational axis. The line that is rotated is at some angle other than  $90^\circ$  from the rotational axis. The surface thus formed is a cone, and this conical surface intersects the lower hemisphere along a small circle.

b) Properties of Cylindrical Folds

1. If planar readings from a cylindrical fold surface are plotted on the stereonet, where the great circles tend to intersect defines the hinge attitude. This is rarely done with large data sets because the large number of intersections is difficult to interpret. This type of diagram is referred to as a *Beta ( $\beta$ ) diagram*.

2. If poles to the folded surface are plotted, the great circle along which they align is the plane perpendicular to the hinge line of the fold. In addition, the two point maxima that occur along this great circle trace can be considered to be the poles to the limbs of the fold. This type of stereogram where poles to the folded cylindrical surface are plotted is termed a *Pi ( $\pi$ ) diagram*.

3. If a lineation existed within a surface, ripple marks within bedding for example, and that surface is later folded into a cylindrical surface, the lineation will have an attitude that keeps a constant angle with the hinge of the fold. This is true if the fold was produced by a *flexural-slip* mechanism. If the mechanism was instead *passive-slip*, the pre-existing lineations would be deformed so as to lie within a plane. They would then plot along a great circle.

### c) Properties of Conical Folds

1. If poles to the folded surface of a conical fold are plotted, they fall along a small circle. The apical angle of the cone containing the poles is the supplementary angle of the folded conical surface. The axis of the cone will be the center of the small circle trace on the stereonet.
2. Remember that the trace of the intersection of a cone with the lower hemisphere on the equal area net is not a circle but is instead an elliptical geometry.

### V. Problems Associated with Fold Analysis on the Stereonet.

- a) Always remember that it is impossible to determine whether or not a fold structure is an *antiform* or a *synform*. This is only possible when the data is plotted on a geologic map.
- b) Although you can plot the limb attitudes from a fold girdle, you cannot directly measure the interlimb angle until you have additional information that describes the attitude of the axial plane. If the fold is described as *upright* you may assume that the axial plane dips steeply. A *recumbent* fold has a horizontal or nearly horizontal axial plane.
- c) An *isoclinal* (both limb are parallel) fold will plot as a point maxima.
- d) The pattern produced by a parallel fold as compared to a chevron fold is different even if they both have the same hinge and axial plane attitudes, and the same interlimb angle.
- e) The *symmetry* of the pattern of contours on the stereogram is correlated to the actual symmetry of the fold limbs.

EXERCISE 5A: Contoured Stereonets and Interpretation of Folded Data

Generate all stereonet diagrams with a radius of 3.5 inches. Label all interpreted and/or calculated geometries on the stereonet, as well as reporting attitudes in the upper left corner of page.

Problem 1: The below data were measured along the limbs of a fold:

286°, 36°SW	040°, 60°SE
330°, 45°SW	357°, 65°SW
079°, 40°SE	053°, 50°SE

plot the following on separate stereonet diagrams:

- (1A)  $\beta$ -diagram (great circles) and estimated hinge attitude
- (1B)  $\pi$ -diagram (poles) and estimated hinge attitude

Problem 2: With the map in **Figure 5-1**, and the below data:

ATTITUDE OF FOLIATION	RAKE OF MINERAL LINEATION
(A) 037°, 30°SE	42°SW
(B) 000°, 40°E	11°S
© 337°, 60°NE	04°NW
(D) 305°, 70°SW	07°NW
(E) 275°, 40°SW	87°SE

Determine the following on separate plots:

- (2A) Determine the plunge and bearing of mineral lineations at stations (A)-(E) with the stereonet.
- (2B) Using appropriate structure symbols for foliation and mineral lineation, plot the above data on the **Figure 5-1** map. Plot the axial trace of the fold on the map and report its attitude.
- (2C) With the stereonet, find the attitude of the fold hinge and the full axial plane attitude. Do this by plotting a  $\pi$ -diagram. Determine the angle between the hinge and each

mineral lineation. Of the following possible types, flexural-slip or passive-slip, is the most likely deformational mechanism?

Problem 3: Below are several attitudes for poles to bedding from a fold structure. Using a stereonet to plot a  $\pi$ -diagram, determine the axis of folding, and whether the fold is conical or cylindrical.

010°, 16°	344°, 47°	285°, 37°
358°, 38°	311°, 50°	278°, 24°

Problem 4: With the foliation data from the below web link construct a contoured stereonet.

[www.usouthal.edu/geography/allison/GY403/GY403\\_lab5A\\_prob4.xlsx](http://www.usouthal.edu/geography/allison/GY403/GY403_lab5A_prob4.xlsx)

The foliation data were obtained from a large mesoscopic fold. This problem should be completed manually. You should turn in the following plots:

(4A) Construct a plot of the poles to the below planar data, including the number of poles per one percent area of the lower hemisphere as calculated from the counting net.

(4B) Construct a plot of the poles per one percent area converted to a percentage of the total number of poles. Also include the contours of density percent on this plot. Label the contour interval and total number of observations on the bottom center of the plot. Use your own discretion in determining the contour interval, but strive for 4-6 discreet levels. Label the point that represents the hinge of the fold with a  $\pi$ , and plot the great circle girdle perpendicular to the  $\pi$  point. Report the hinge attitude as estimated with the  $\pi$  method.

Problem 5: The below data in the web link are foliations collected in the Blue Ridge of north Georgia:

[www.usouthal.edu/geography/allison/GY403/GY403\\_lab5A\\_prob5.xlsx](http://www.usouthal.edu/geography/allison/GY403/GY403_lab5A_prob5.xlsx)

Note that the data are listed in azimuth and dip format. With these data:

(5A) Plot the poles to foliation and raw number of poles per one percent area. Visually estimate the "best-fit" great circle girdle that passes through the poles.

(5B) Plot contours of the percent density of data, including the percent density values used for contouring on the plot. Label the contour interval, and the number of data used for the

plot, centered below the stereonet. Determine the attitude of the hinge of the fold affecting this data by plotting the great circle girdle, and label the pole to this great circle as "HINGE" on the net. Indicate whether or not this fold is symmetrical or asymmetrical.

You will be required to use the computer program NETPROG to complete this problem. The procedure for producing hard copy output on the computer will be demonstrated in lab. The program can output all necessary elements of the problem so you should not have to draft anything for this problem.

Problem 6: Given the data in the below web link, find attitude of the lower Ordovician Mascot Dolomite before deposition of the middle Ordovician Chickamauga Limestone. An angular unconformity separates the two lithologies. You may use the computer program to help solve this problem. "Eyeball" an average orientation (center of gravity) to poles for the Chickamauga to determine the rotation for the Mascot formation. Then rotate the Mascot data to its pre-unconformity orientation by moving each pole about the rotational axis, and then re-plot the pole. The attitude of the Mascot data prior to deposition of the Chickamauga can be determined from the center of gravity of the rotated Mascot poles. It is recommended that you use the computer program to accomplish the above rotation step. You should turn in on separate plots:

[www.usouthal.edu/geography/allison/GY403/GY403\\_lab5A\\_prob6.xlsx](http://www.usouthal.edu/geography/allison/GY403/GY403_lab5A_prob6.xlsx)

(6A) The poles to the Chickamauga data along with the visually selected center of gravity of the data. Using a great-circle arc indicate the path that the center of gravity pole would follow if the plane it represents were rotated to a horizontal attitude. Report the attitude of the axis of rotation, and the amount of rotation necessary.

(6B) The poles to the Mascot data in their present-day attitude, and the rotated pre-unconformity attitude (Use the "solve > rotate data" menu in NETPROG and save the results to a separate file). Use a cross for attitudes before rotation, and a triangle for attitudes after rotation.

(6C) Plot the rotated pre-unconformity poles determined in (6B), and the center of gravity of the poles. Convert the center of gravity pole to a strike and dip and report that as the final answer. Also plot the great circle  $90^\circ$  from the center of gravity pole.

## EXERCISE 5B: Contoured Stereograms and Interpretation of Folded Data

Problem 1: With the below bedding data (see web link) construct a contoured stereogram. Find the following:

- (a) Hinge attitude.
- (b) Axial plane attitude given that the axial trace is N50E.
- (c) Fold interlimb angle.

Data web link:

[www.usouthal.edu/geography/allison/GY403/GY403\\_lab5B\\_prob1.xlsx](http://www.usouthal.edu/geography/allison/GY403/GY403_lab5B_prob1.xlsx)

After plotting the poles to bedding (manual or NETPROG), use the counting net to manually count the percent concentration nodes. For problem 1 turn in on a single stereonet sheet:

1. Percent concentration node values that are non-zero.
2. 2% concentration contours drawn manually.
3. Hinge attitude labeled on the stereonet and reported in the upper left answer section
4. Axial plane attitude labeled on the stereonet and reported in answer section
5. Fold limbs plotted as great circles and the interlimb arc angle labeled along the fold girdle.

Problem 2: The below web link contains data that have been collected from folded Paleozoic rocks in the Picuris Range of North New Mexico. Using the stereonet application “NETPROG” plot the data as poles to bedding along with the percent concentration node values. Contour the diagram at a contour interval of 2% using a Gaussian calculation scheme. Given that the axial trace of folds has been measured from geologic maps to be N19W in this region, calculate the following and plot on the stereonet:

- (a) Hinge attitude
- (b) Axial plane attitude
- (c) Fold interlimb angle

On a second sheet of paper discuss the symmetry of the fold as shown by your contour pattern.

Data web link:

[www.usouthal.edu/geography/allison/GY403/GY403\\_lab5B\\_prob2.xlsx](http://www.usouthal.edu/geography/allison/GY403/GY403_lab5B_prob2.xlsx)

Problem 3: The below web link contains foreset bedding readings from the Red Mt. Formation near Birmingham, AL. The Red Mt. Formation is a Silurian sandstone unit affected by folding. Assume that all of the readings were taken from the same outcrop where primary bedding has been measured as 038, 44SE. Construct the following diagrams using NETPROG:

- (a) Plot the poles to foreset beds as a contoured stereonet plot with contour interval of 4%, beginning at 2%. Also plot the percent concentration node values, and the great circle representing the primary bedding attitude. Use the least-squares vector fit to calculate the mean attitude of the foreset poles.

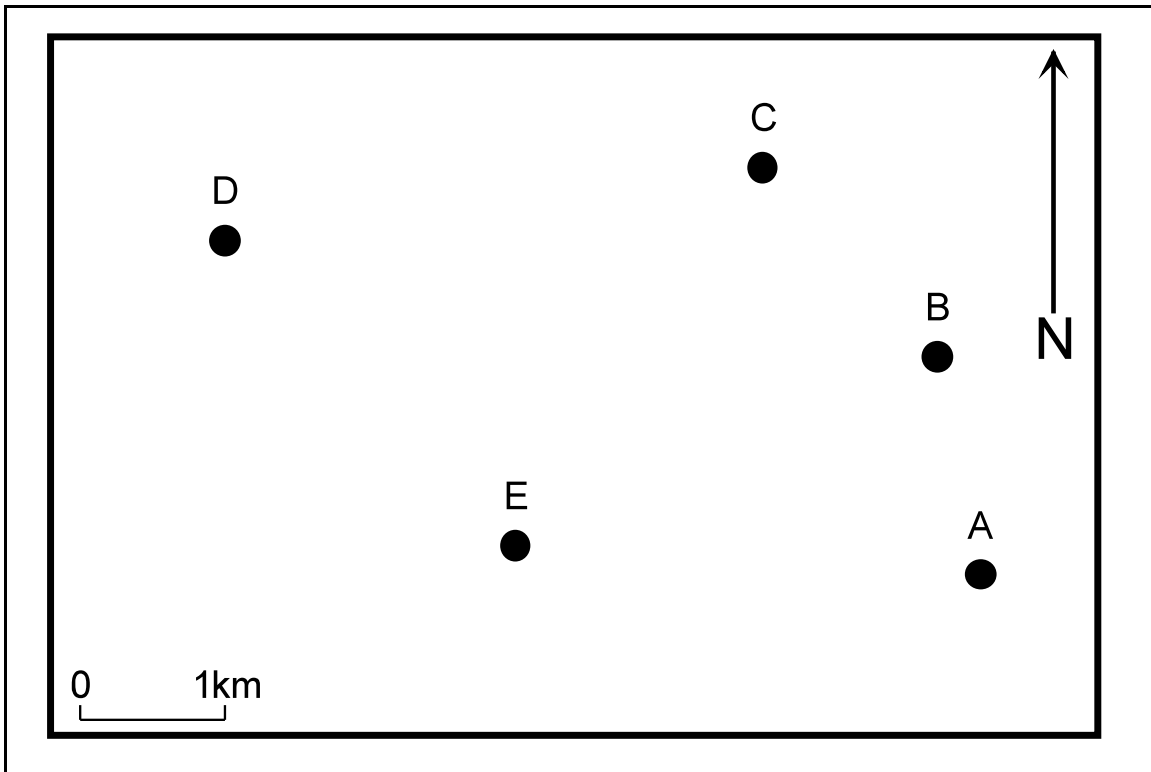
Convert the average foreset pole to a strike and dip, and report the answer as the average foreset attitude in the current (deformed) state.

(b) Determine the rotation axis, amount of rotation, and sense of rotation assuming that primary bedding should be put back to its original horizontal position. Use the rotation option in NETPROG to process the rotation, save the results to a different file, and then load this file into NETPROG. You should then see the rotated poles to foresets. In addition to the rotated poles to foresets, plot the following:

1. Percent concentration nodes
2. Contours of rotated data starting at 2%, with a 4% interval (same as in (a))
3. Least-squares vector fit to the rotated foreset poles representing the average attitude of the poles to foresets during deposition.
4. The great circle representing the actual strike and dip of the average foreset attitude during deposition.
5. Plot the point representing the true dip plunge and bearing of the rotated average foreset, and report the bearing as the paleocurrent direction.

Data web link:

[www.usouthal.edu/geography/allison/GY403/GY403\\_lab5B\\_prob3.xlsx](http://www.usouthal.edu/geography/allison/GY403/GY403_lab5B_prob3.xlsx)



**Figure 5-1** : Map for problem 2B.

# COUNTING NET

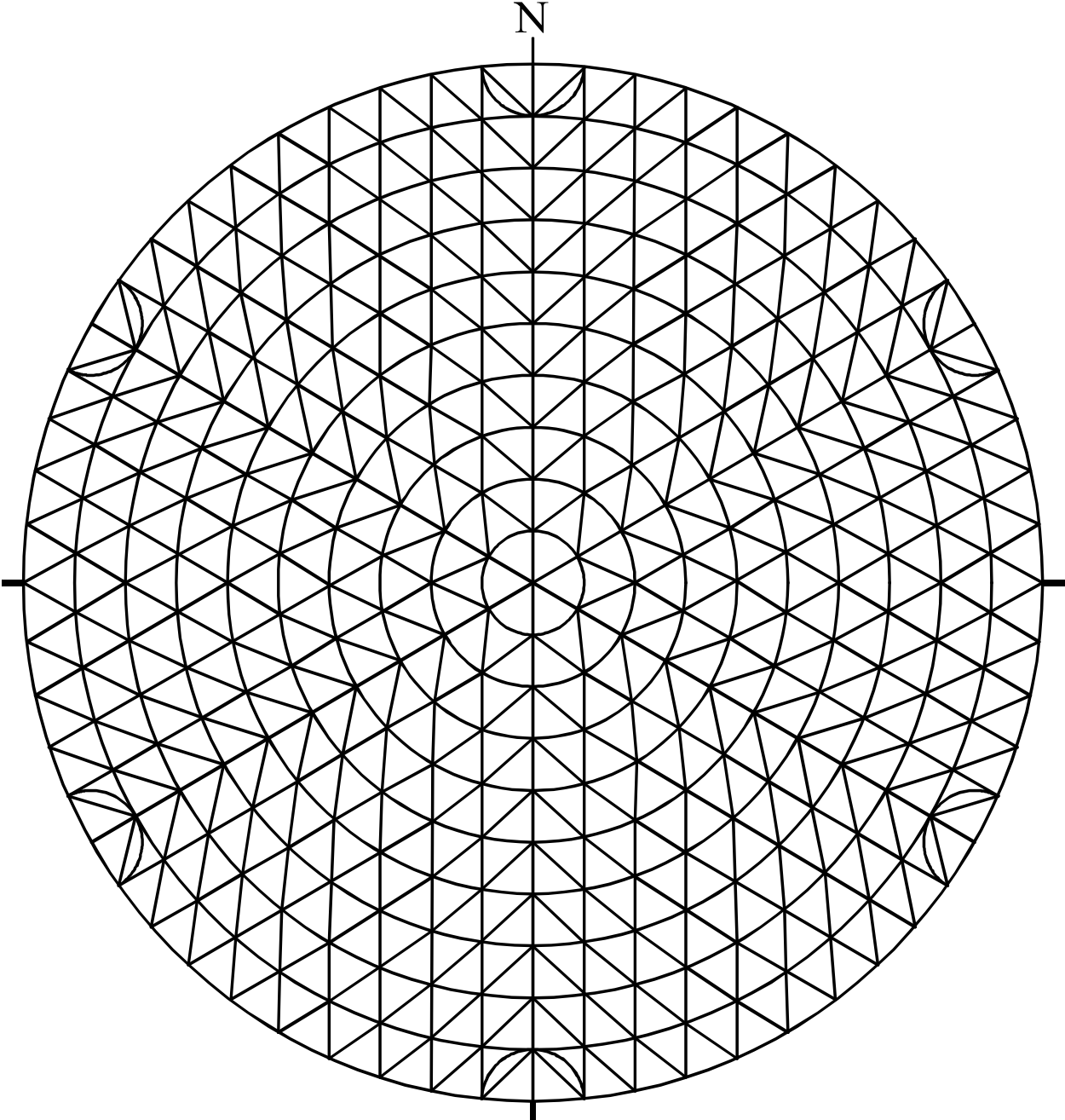


Figure 5-2 : Counting net (equal area).



## LABORATORY 6: Campus Geologic Mapping Project

### I. *Mesosopic Structure* Symbols (outcrop scale)

#### (A) *Bedding/compositional layering* ( $S_0$ )

Bedding contacts are primary sedimentary structures. They may be associated with other primary sedimentary structures such as *crossbedding*, *graded bedding*, and *ripple marks*. An outcrop may contain multiple layers that differ in composition, however, if the layers have been recrystallized by metamorphism you cannot assume that this represents bedding unless you recognize primary features. In this case you should use the term *compositional layering*.

#### (B) *Foliation or Cleavage* ( $S_1$ )

Foliation is a preferred alignment of mineral grains in a rock. The microscopic occurrence of this property is termed *cleavage* because it will impart a pronounced parting to the rock if struck by a hammer.

#### (C) *Lineation* ( $L_1$ )

*Mineral lineation* is the parallel alignment of mineral grains.

*Intersection lineation* is a streaky lineation caused by the intersection of cleavage or foliation with *compositional layering* ( $S_0$ )

#### (D) *Fold Hinge* ( $F_1$ )

The hinge consists of the points of maximum curvature along a single folded surface.

*Fold symmetry* relates to the shape of an asymmetric fold viewed in the down plunge direction of the hinge. The shape will appear as a "Z", "S", or "M", and should be noted. The symmetry is related to megascopic folding of same generation

#### (E) *Axial plane* ( $AP_1$ )

The axial plane is the plane that contains multiple hinge line points along the fold profile. Typically this is measured by aligning a clipboard with the imaginary plane that contains several hinge lines in a fold profile. You must be able to see significant three-dimensional relief on the outcrop surface to be able to accurately measure the axial plane attitude.

#### (F) Joints

The number of joint surfaces exposed at a given outcrop is often a very large number so it

is not usually possible nor desirable to measure every single occurrence. Instead you should look for *joint sets*- two or more joints with similar orientation. Often there are only two or three sets at a given exposure. The orientation pattern of joint sets can often delineate the orientation of the principal components of the stress field that caused the fracture system to develop.

## II. *Megascopic Structure Symbols (map scale)*

### (A) *Depositional contacts and igneous contacts*

For depositional contacts use a normal line width (i.e. #0 rapidograph pen).

An *Unconformity* may be indicated by hachures on the young side (upper) of the unconformable surface, however, since unconformities are depositional contacts you must use a normal width line (i.e. #0 rapidograph) for the contact.

### (B) *Fault Contacts*

Use a thick line width (#2 rapidograph) to distinguish faulted contacts from other contacts. In general, any symbols used with a fault contact are placed on the hanging wall side of the fault. Fault contacts with teeth on the hanging wall traditionally represent low-angle *reverse fault (thrust)* contacts.

*Normal fault (hanging wall down)* contacts should have hachures on hanging wall side of the contact. A "U" and "D" is often used to distinguish the upthrown and downthrown fault blocks. Most normal faults dip steeply. If the fault dips 90°, use the "U" and "D", and put hachures on the downthrown block.

*Reverse fault (hanging wall up)* contacts are plotted with the teeth symbols on the hanging wall block. If a reverse fault dips at a low-angle it is termed a thrust fault.

A *strike-slip fault* is plotted with arrows on opposite sides of the fault contact, and these arrows should accurately describe the sense of motion on the fault.

### (C) *Megascopic Folds*

The axial trace of a fold should be plotted as a thick line (i.e. a 0.7mm or similar pen) weight with a large arrow indicating the general plunge direction. If the fold hinge is not parallel to the axial trace (strike of axial plane), an arrow indicating the hinge attitude should be drawn off of the axial trace line. Symbology on the axial trace should indicate the difference between an antiform and a synform. The dip of the axial plane should be represented with a tic mark in the dip direction and a number indicating the angle value.

An *Asymmetric fold* is a fold where one limb is significantly longer than the other. This produces a “Z” or “S” symmetry when viewed in profile. A symmetric fold, one with equal length limbs appears as an “M” shape. These folds are also termed *neutral* folds.

An *Overtured fold* contains a limb which has been rotated more than 90 degrees from the original horizontal attitude. If the limb is composed of bedding, the bedding is overturned on the overturned limb (i.e. younger beds are encountered at depth).

A *Recumbent fold* is a fold with a horizontal axial plane.

*Dome* and *Basin* fold structures are indicated by circular contacts. Domes will have older strata in the core of the structure, whereas basins will contain younger strata in the core.

A *Doubly-plunging* fold contains a hinge line that gradually changes attitude. The map pattern of contacts will be elliptical in this case. An elliptical pattern of contacts with older strata in the core of the structure is a doubly-plunging anticline; younger strata in the core indicates a doubly-plunging syncline.

#### (D) *Antiform, Synform, Anticline, and Syncline*

Remember that the term antiform and synform describe the geometry indicated by structure data- and nothing more. An antiform is a structure in which the limbs of the fold dip away from the axial trace on the map. A synform contains limbs which dip toward the axial trace. In cross-section profile an antiform is concave down, and synform is concave up.

Anticline and syncline terminology can be used only when age relationships are known. Anticlines have older strata in the core of the structure (map or cross-section view), whereas a syncline must have younger strata in the core of the structure.

Note that it is possible for there to exist an *antiformal syncline*, a structure which is concave down in profile, but contains younger material in the core of the structure. The opposite structure, a *synformal anticline*, can and does exist in highly deformed terranes.

(E) Several deformational phases may produce complex "*superposed*" folding that produces fold structures such as an antiformal syncline or synformal anticline.

### III. Pace and Compass Traverse

#### (A) *Pace length* calculation

1. Make multiple pace counts over known distance measured with tape measure.
2. Average the pace count values and divide into the known distance to give a distance per pace value (usually feet per pace).

3. Calculate the average of the pace count trials and standard deviation. Use the average for subsequent distance calculations and the standard deviation as a confidence limit on your estimate.
4. Write the pace count average down in your field notebook and use it to calculate distances from pace totals along *traverse legs*.

(B) *Traverses* are made to mark the progress of moving across a map area. If the scale of the map is not sufficiently large, or a map area lacks landmarks, a traverse will be made to locate stations. Each leg of a traverse is made along a constant azimuth. The distance is calculated using a pace count.

(C) A *closed traverse* is made when the end of the traverse is at the same point as the beginning. Since the error inherent to azimuth and pace measurements inevitably cause the closed traverse to not "close" when plotted on paper, these traverses must be corrected using the vector defined by the starting and ending points as plotted on the map. The correction should be calculated as below:

1. Determine the magnitude and direction of the vector described by the "gap" between the first and last point of the closed traverse. The direction of this error vector should be in the sense of travel from the endpoint of the last leg, to the start of the traverse.
2. Divide the magnitude of the error vector by the number of legs of the traverse. For example, if the error magnitude was 75 feet, and there were three legs to the closed traverse, then this increment value would be 25 feet.
3. Starting with the end of the first leg of the traverse (station 2), displace the plotted position of the station in the direction of the error vector by a distance equal to the leg # times the increment calculated in (2). For leg #1 this distance would be 25 feet, leg #2 50 feet, etc.
4. When (3) is applied to the last leg of the traverse the new position of the last station of the traverse should be directly on the origin point (station 1) of the traverse. This, in effect, "closes" the traverse. Attitude data that was collected at the various stations should now be plotted at the corrected station positions.

**NOTE: If you have already completed the pace length calculation and statistics in a previous course you can use that value for this exercise.**

## EXERCISE 6: Geologic Map and Structural Analysis General Instructions

### General Instructions for Lab 6 (6A=Gold course & 6B=White course)

In this exercise you will collect field data with which you will construct a geologic map. In addition to the geologic map, you will analyze the attitude data with the stereonet. You may want to review the use of the Brunton Compass (Pocket transit), and the organization of field notes in your lecture text.

The class will meet outside the Life Sciences building near the parking lot for orientation. Marked on the campus property adjacent to the Life Sciences building will be several stations that are the targets for the pace and compass traverse. At each station will be a model that simulates a bedding plane. Your team will measure the attitude of bedding with a pocket transit at each station and record that information into a notebook. On the bedding plane surface will be a pebble lineation simulated by a strip of masking tape. You are to measure that attitude as a plunge and bearing/azimuth. As your team moves from station to station, you are to measure the azimuth of the direction of travel, and record the pace count. This allows you to later plot and correct a closed traverse of all stations. At the beginning of the lab period I will give a brief lecture on the use of the pocket transit and the calculation of a pace count. Make sure that you understand the below steps before beginning the problem:

1. Calculation of your pace count including percent error for distance measurement (you may have already completed this step in a prior course).
2. Setting of magnetic declination on the Brunton compass.
3. Measurement of azimuth direction from station to station with Brunton compass.
4. Calculation of distance between two points with pace count.
5. Measurement of strike and dip of bedding.
6. Measurement of plunge and bearing of pebble lineation.
7. Determination of plunge and bearing of pebble lineation on steeply-dipping surface with a rake angle.

## EXERCISE 6A Geologic Map and Stereonet Analysis

Problem 1: Plot the structure data collected at each station on the closed traverse. Use the adjusted position of the stations- not the original position. The following geologic information was collected at stations 1 through 8 along the campus traverse. You can assume that no exposure was encountered along the traverse between stations (but that does not mean that contacts cannot project between stations!):

(Gold Course)

Station 1: Contact between the Cambrian siltstone to the southwest and Ordovician limestone to the northeast.

Station 2: Contact between the Ordovician limestone to the southwest and the Silurian sandstone to the northeast.

Station 3: Contact between the Silurian sandstone to the southwest and the Devonian shale to the northeast.

Station 4: No formation contact observed. Bedding measured was in the Silurian sandstone.

Station 5: Contact between Cambrian siltstone to the northwest and Precambrian schist to the southeast.

Station 6: Contact between Cambrian siltstone to the southwest and Precambrian schist to the northeast.

Station 7: Contact between Silurian sandstone to the southwest and Ordovician limestone to the northeast.

Station 8: Contact between Ordovician limestone to the southwest and Cambrian siltstone to the northeast.

Use the following information for plotting the geologic map and constructing a legend:

Formation	Lithology	Pattern	Color
Devonian	shale	dashed	brown
Silurian	sandstone	dotted	red
Ordovician	limestone	blocked	blue
Cambrian	siltstone	dotted & dashed	orange
Precambrian	schist	“use your imagination”	green

You should try to project contacts so that the entire map area is covered by one of the above color and pattern combinations. Use a dashed contact line to indicate approximate contacts. If a fold structure is indicated by the exposure pattern, draft the axial trace and antiform/synform megascopic structure symbols appropriate for the structure (don't forget about overturned bedding symbols). Use a #0 rapidograph pen for depositional or igneous contacts, and a #2 rapidograph pen for fault contacts and megascopic fold structural symbols. Your geologic map should contain all of the elements that are discussed in your lecture text (i.e. scale, title, geographic and magnetic north, and explanation). Scale: 1 inch = 100 feet.

Problem 2: For the stereonet portion of problem one, plot bedding as great circles (Beta diagram).

Plot pebble lineations as filled triangles. If a fold structure is indicated by the data, also plot the following:

- Best “visual” or statistical fit (NETPROG) of hinge point labeled “hinge” as a filled circle.
- Axial plane of the fold as a great circle labeled as “axial plane”.
- Interlimb angle of the fold plotted as measured along the great circle perpendicular to the hinge point. Plot this great circle and the two points used for measuring the interlimb angle. Label the angular arc as the “interlimb angle”.

Report the attitude of the hinge, axial plane, and the interlimb angle value as answers.

## EXERCISE 6B Geologic Map and Stereonet Analysis

Problem 1: Plot the structure data collected at each station on the closed traverse. Use the adjusted position of the station on the closed traverses- not the original position. The following geologic information was collected at stations 1 through 9 along the campus traverse. You can assume that no exposure was encountered along the traverse between stations (but that does not mean that contacts cannot project between stations!):

(White Course)

Station 1: Contact between the Cambrian siltstone to the northwest and Ordovician limestone to the southeast.

Station 2: Contact between the Precambrian gneiss to the northwest and the Cambrian siltstone to the southeast.

Station 3: Contact between the Precambrian gneiss to the north and the Cambrian siltstone to the south.

Station 4: Contact between the Precambrian gneiss to the northeast and the Cambrian siltstone to the southwest.

Station 5: Contact between Silurian sandstone to the northeast and Devonian shale to the southwest.

Station 6: Contact between Precambrian gneiss to the east and Cambrian siltstone to the west.

Station 7: Silurian sandstone bedding encountered.

Station 8: Contact between Devonian shale to the northwest and Mississippian chert to the southeast.

Station 9: Contact between Silurian sandstone to the northwest and Devonian shale to the southeast.

Use the following information for plotting the geologic map and constructing a legend:

Formation	Lithology	Pattern	Color
Mississippian	chert	triangles	gray
Devonian	shale	dashed	brown
Silurian	sandstone	dotted	red
Ordovician	limestone	blocked	blue
Cambrian	siltstone	dotted & dashed	orange
Precambrian	schist	wavy lines	green

You should try to project contacts so that the entire map area is covered by one of the above color and pattern combinations. Use a dashed contact line to indicate approximate contacts. If a fold structure is indicated by the exposure pattern, draft the axial trace and antiform/synform megascopic structure symbols appropriate for the structure (don't forget about overturned bedding and/or limb symbols). Use a #0 rapidograph pen for depositional or igneous contacts, and a #2 rapidograph pen for fault contacts and megascopic structural symbols such as a fold. Your geologic map should contain all of the elements that are discussed in your lecture text (i.e. scale, title, geographic and magnetic north, and explanation). Scale: 1 inch = 100 feet.

Problem 2: Plot bedding as great circles (Beta diagram). Plot pebble lineations as filled triangles. If a fold structure is indicated by the data, also plot the following:

- Best visual fit of hinge point labeled “hinge” as a filled circle
- Axial plane of the fold as a great circle labeled as “axial plane” in red color
- Interlimb angle of the fold plotted as measured along the great circle perpendicular to the hinge point. Plot this great circle and the two points used for measuring the interlimb angle in blue.

Report the attitude of the hinge, axial plane, and the interlimb angle value as answers.

## LABORATORY 7: Geologic Map & Cross Section Field Project

In this lab you will be transported to a interesting geological site for a mapping project where you will collect basic geological structure data and turn that data into a geologic map and cross section. Below are some helpful hints to guide you to a successful conclusion.

### Items required for the day of the field exercise

1. Notebook for taking notes. It should be able to survive getting wet if it does rain.
2. Lead and color pencils.
3. Clipboard or similar planar item to use for measuring strike and dip. Your notebook may serve for this purpose if it has a stiff backing. You will also use this as a backing for plotting symbols on your map so try to get a clipboard that is larger than your 8.5 x 11" base map.
4. Tracing paper for stereonet.
5. Stereonet.
6. Marker for samples.
7. One backpack or rucksack per group for samples
8. One rock hammer per group for samples.
9. If a Brunton has been assigned to you please do not forget to bring it with you to the field exercise site!
10. Make sure that you bring some type of rain gear for protection from inclement weather.

### Guidelines for Collecting Field Data

(1) **KNOW WHERE YOU ARE!** Before you get into the details of collecting data at the exposure, mark your location on the map and label it with the station number. Use the GPS, topographic contours, stream drainage, roads, etc., to estimate where you are. If you don't plot your position on the map accurately, your data may be worthless. If necessary, use pace and compass techniques to determine your position on the base map.

(2) Inspect all of the outcrop before taking measurements. You will need to guard against becoming so involved with making measurements and writing them down that you forget to investigate all of the exposure.

(3) Use teamwork. You will be in groups of two or three. There will be one Brunton compass per group. One person makes measurements with the Brunton while the other takes notes. If there is a third person, he/she stands over the person making measurements to make sure that the measurements are done correctly. The third person should also read over the notes taken to make sure that everything was taken down correctly. At 2:00PM you can copy each others notes for the day (i.e. data is copied to one notebook during data collection).

(4) Systematically record the following outcrop characteristics, if present, at the exposure:

a. Lithologic type and mineralogy. Is it sedimentary, igneous, or metamorphic? What is the mineralogy, and proportions of minerals? Describe any distinctive textures.

b. Primary features should be described. If bedding is present, describe the thickness. Does the texture change up or down in the section? Are ripple marks or crossbeds present? Do any of these features indicate a **facing direction**? If the rock is metamorphic, is there a preferred alignment of minerals? If so, is a foliation or lineation defined?

c. Are there identifiable units present at the exposure that are thick enough to plot on the map scale? If so, try to walk along the contact as far as you can. Trace the contact on the map as you go.

d. After all primary and secondary structures have been identified and noted, systematically measure the attitude of each and record these readings in your notebook. Remember to use the correct format for planar versus linear structures. If you can identify outcrop-scale folds, measure the hinge and axial plane attitudes. Don't forget to measure primary sedimentary structures such as crossbedding or ripple marks. When you measure a planar structure, don't forget to note the dip direction quadrant.

e. If a contact is present at the exposure, carefully note its relationship with other contacts. Does it offset or truncate other contacts? What relative age relationships are suggested at the exposure? Are there **slickensides** or **cataclastic** textures associated with the contact?

f. Before leaving the exposure, think about any possible geometric relationships between structural elements. Is the foliation axial planar to folds? Does bedding always dip steeper than foliation? Are mineral lineations and fold hinges parallel? If these types of relationships are discovered, note them in your notebook.

g. If you think that you need more time to fully describe the texture and/or mineralogy of the lithology, take a hand sample. Label the hand sample with the station label.

(5) As you collect data and if you have time, roughly sketch in structure symbols and contacts on your base maps. You can plot these more accurately with a protractor at the end of the day. As you collect data through the day, periodically look at your map. Try to recognize any systematic pattern to the structure data and/or contacts.

## EXERCISE7A: High Fall Branch Geologic Map & Cross-Section

Problem 1: Collect data within the High Fall Branch map area with you assigned group. Do not split up during the course of the project. You will have from approximately 8:00AM to 2:00PM to collect data. You must have a minimum of 12 stations to sample the map area adequately, so this gives you an average of 30 minutes per station. You must also disperse the station locations so that they are not grouped at one location on the map. The exposure is very good in this area so there is a danger that you might spend too much time in one location. I suggest that you make sure that the first 12 stations cover the map area, then come back to exposures that interest you. The following structures may be found at a any given station:

- Bedding and crossbedding ( $S_0$ )
- Cleavage or Foliation ( $S_1$ )
- Pebble lineation or intersection lineation ( $L_1$ )
- Fold Hinge ( $F_1$ )
- Axial Plane ( $AP_1$ )

It is important that you accurately determine the location of a station by recognizing topographic features and relating them to your base map. The road, hiking trail, and stream are particularly useful for this. If you finish collecting data before other groups, use that time to plot the structure data on the stereonet. You can also qualitatively plot the structure symbols on your map to see if any fold or fault structures are apparent. Since only one of the group should be recording notes, the other members should use this time to make copies of the data.

The formal designation for the lithology that outcrops throughout the exercise area is the Siluro-Devonian Cheaha Quartzite (S-Dtcq). It is actually a metasediment since primary depositional features such as bedding, crossbedding, channel lag deposits, and ripple marks can be found in this formation. At each data station describe to the best of your ability what occurs at the location. Look for primary features such as bedding, cross-bedding, graded beds, etc. Also describe secondary structures related to deformation such as stretch pebble lineation. Also outcropping in the study area is the Devonian Erin Slate (Dtes) which actually is a phyllite in this particular area. The phyllite will contain a strong rock cleavage which should be recorded as a planar  $S_1$  reading. A major goal of the mapping will be to discover the contact between the quartzite and phyllite. Also exposed in the mapping area is the Jemison metachert, a papery quartzite and phyllite (Dtjc), the Hillabee Greenstone (D(?)hgs), and the Ashland mica schist (p-Ca). The Dtjc and D(?)hgs display a planar rock cleavage ( $S_1$ ) that can be measured as strike and dip. The p-Ca has a coarse schist foliation defined by muscovite preferred alignment that can be recorded also. Any of these metamorphic rocks may contain a mineral lineation ( $L_1$ ) that may be measured as azimuth and plunge.

The following list defines the various products that you should turn in for this exercise:

### **Geologic Map**

1. Prepare a clean base map by tracing the base map given to you for the project onto paper or vellum with a 0.35mm pen. You do not need to trace the topographic base map features.

2. Plot all contacts and structure symbols (bedding,  $S_1$ ,  $L_1$ , etc.) on the map. You do not have to plot the station labels used in your notes on the map. All elements are to be plotted with a 0.35mm pen unless a fault contact is discovered, in which case use a 0.70mm pen. Dash uncertain contacts. Place the lithologic code abbreviations (i.e. S-Dtcq) inside the appropriate exposure area.

3. Include in a legend along the right margin the explanation of lithologic symbols, structure symbols, and contacts. Trace the legend information given on the field map used for this project.

4. If any large fault or fold structures are discovered, plot them on the map with appropriate symbols and line width. Fault contacts and megascopic folds should be plotted with a 0.7mm pen. Hinge and axial plane attitude information should be added to the axial trace of the fold (attitude information will be derived from the stereonet).

5. Use the following color code

1. D(?)hgs:	Olive green
2. Dtjc:	Pink
3. Dtes:	Light gray
4. S-Dtcq	Lavender
5. p-Ca	Ruby red

### **Cross-Section**

Use the provided cross-section grid to construct the geologic cross-section. Remember to use apparent dips where necessary. The V.E. is equal to 1- no vertical exaggeration. Use the same color coding as per the geologic map. Fault contacts should use a 0.7mm pen, otherwise use a 0.35mm pen.

### **Stereonet**

With the structure data collected during this exercise, plot each structure element on separate stereograms. Fold hinges and lineations may be combined on a single diagram. Plot all planar structures as poles, except axial planes which are plotted as great circles. Because you have variety of structures on one stereogram, you must use symbol coding:



## EXERCISE 7B: Tannehill Historical S.P. and Vicinity Geologic Map & Cross-section

Problem 1: You will be provided with a topographic base map with the mapping area indicated by a magenta rectangular area. The cross section will be marked by an A-A' line cutting across the map area. The scale of the map will be 1:24,000 (1 inch = 2000 feet). You will be mapping in an area that is affected by the Birmingham Anticline, and thrust faulting is a definite possibility in this region. You will begin mapping the southeast limb of the anticline along the Tannehill S.P. exit road, which at the entrance is close to the core of the anticline, and work your way into the park itself is on the southeast flank of the fold. Along the way you should note any recognizable formations that range in age from Cambrian to Mississippian. A handout describing the various formations will be given to each group before mapping begins. Each group should measure the orientation of bedding whenever good exposures are encountered even though these exposures may not correspond to the contact between 2 formation. A quick inspection of your topographic base will confirm that some formations are ridge-formers whereas others are valley-formers. Therefore, you should suspect the presence of a contact whenever you encounter a distinctive topographic break that is recognizable on the topographic map. When you take bedding readings and/or find contacts using topographic breaks use the GPS receiver to mark a waypoint and make sure that you describe what is found at the waypoint in your notebook.

After mapping the southeast limb you will be transported to the northwest limb in vans where another transect will be run near the A-A' cross section line. From your data construct the following products:

I. Geologic Map (1:24,000 scale) on 24 x 36 inch vellum/paper (ink with a rapidograph, color with color pencils)

- a. Use a #0 (.35mm or similar) for plotted contacts, strike and dip data symbols, plunge & bearing data symbols; Use #2 (.7mm or similar) for faults and/or megascopic fold structure symbols
- b. Geographic North Arrow with declination
- c. Explanation (structures and lithology symbols- see example in textbook)
- d. A-A' cross section line
- e. Formation abbreviation (e.g. Oc, Mf, etc. ) inside each lithologic polygon
- f. Graphical scale in metric units and RF
- g. Thrust faults should have teeth on hanging wall block
- h. Megascopic fold axial trace should have hinge and AP attitude information calculated from the stereonet
- i. Use topographic ridges and valleys to extrapolate the geology to cover the entire map area. Use dashed contacts for areas far from data control.
- j. Label the latitude and longitude at map corners.
- k. Lithologic Symbols
  1. |Ppv (Pottsville Fm) color = Lt. Blue (sandstone & shale pattern on x-section)
  2. Mpw (Parkwood Fm) color = purple (sandstone & shale pattern on x-section)
  3. Mf (Floyd Fm.) color = dark blue (shale pattern on x-section)

4. Mh (Hartselle Fm) color = yellow (sandstone pattern on x-section)
5. Mpm (Pride Mt. Fm.) Color = tan (shale pattern on x-section)
6. Mtfp (Fort Payne Fm) color = green (chert pattern on x-section)
7. Srm (Red Mt. Fm) color = heliotrope (lavender) (sandstone & shale pattern on x-section)
8. Oc (Chickamauga Fm.) Color = pink (limestone pattern on x-section)
9. -COk (Knox Group) color = orange (dolostone pattern on x-section)
10. -Cc (Conasauga Fm.) Color = brown (dolostone pattern on x-section)

II. Geologic Cross Section (1:24,000 horz. scale; 1:24,000 vert. Scale; VE=1) constructed below map

- a. Use #0 for contacts, #2 for faults
- b. Label ends with A and A', and the azimuth directions of the cross-section.
- c. Topographic profile constructed from topographic base map.
- d. If necessary, account for apparent dips when A-A' is not perpendicular to strike of contact.

III. Stereonet

- a. Plot Bedding as poles to define fold girdle. Calculate the hinge and AP attitude from the stereonet and map, and add the appropriate symbols to the axial trace on the map. Estimate and report the interlimb angle using the pole concentrations.

## LABORATORY 8: Thickness and Outcrop Width Problems

### I. Thickness of Strata

a) *True Thickness (t)*- distance measured perpendicular to the upper and lower contact of a tabular unit.

b) *Apparent Thickness*- vertical distance between an upper and lower contact in a non-horizontal unit. The apparent thickness is equal to the true thickness only when the attitude of the unit is horizontal.

c) *Outcrop Width (w)*- distance on the map between the bounding contacts of a tabular unit measured along an azimuth perpendicular to strike.

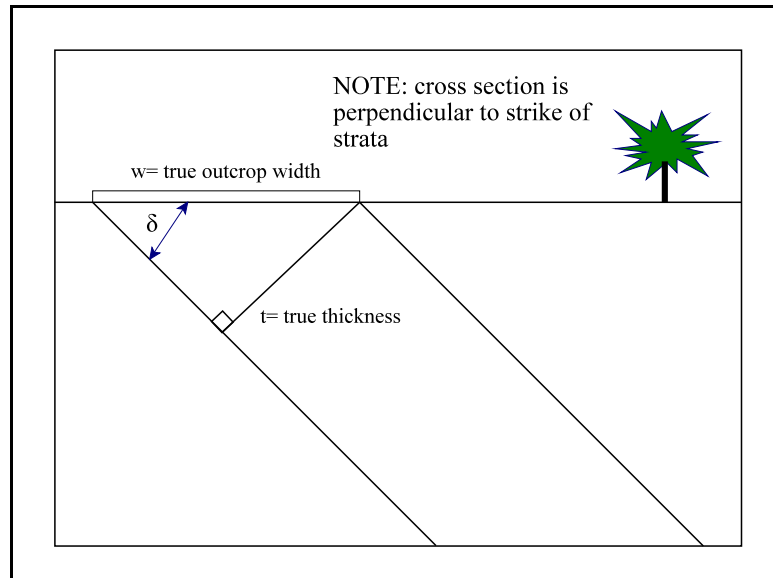
d) *Apparent Width (w')*- distance on the map between the upper and lower contacts of a tabular unit measured in a direction other than perpendicular to strike.

e) Special attitudes:

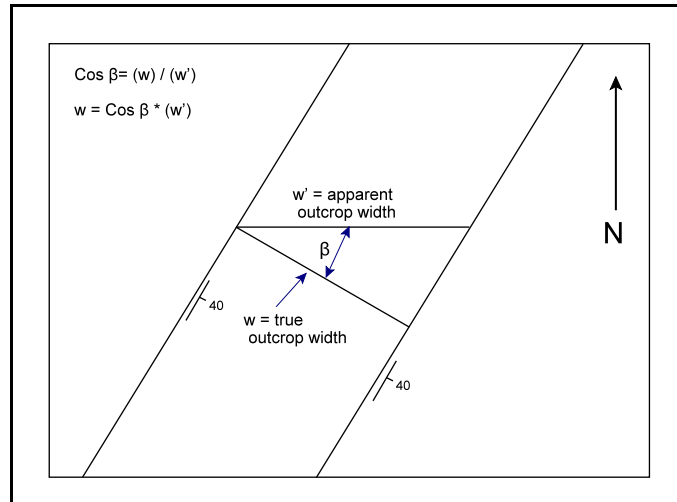
1. Vertical strata: if the map surface is relatively horizontal, the distance measured perpendicular to the contacts is the true thickness.

2. Horizontal strata: the elevation difference between the upper and lower contacts is the thickness.

f) Inclined strata on a horizontal map surface, traverse taken perpendicular to strike (Figure



**Figure 8-1** : Relationship of outcrop width ( $w$ ) to stratigraphic thickness ( $t$ ).



**Figure 8-2** : Relationship between apparent ( $w'$ ) and true ( $w$ ) outcrop width.

8-1).

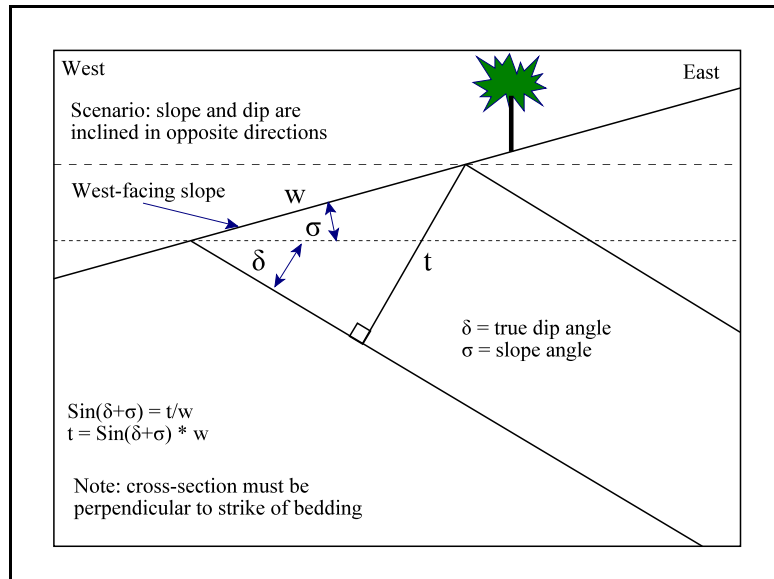
1. Map outcrop width is an apparent thickness termed the outcrop width (w).

2. Trig equations

$$\sin(\delta) = (\text{opposite side})/(\text{hypotenuse}) = t/w \quad (1)$$

$$t = \sin(\delta) * (w)$$

Note that for the above cross-section the solution may be diagramed graphically using a specific scale, rather than using the trig equations. This is also true of all of the following examples in this chapter, although graphical solutions may require more than one construction.



**Figure 8-3 :** Cross-section of thickness with slope problem.

g) Inclined strata below a horizontal topographic surface; traverse taken oblique to strike:

1. First step must correct the apparent outcrop width (w') to the true outcrop width (w):

$$\cos(\beta) = (w) / (w') \quad (2)$$

$$w = \cos(\beta) * (w') \quad (\text{see Figure 8-2})$$

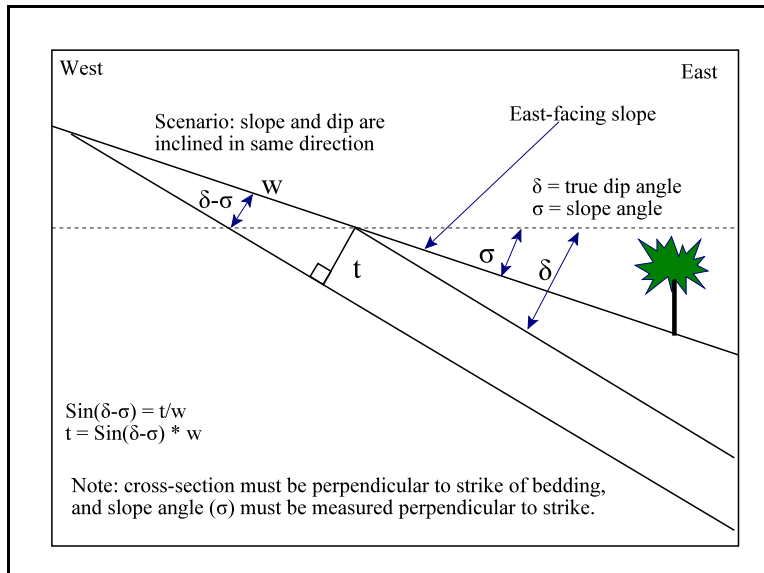
where beta is equal to an angle less than 90° between true dip direction bearing and traverse direction. The true outcrop width = (w), whereas (w') represents apparent outcrop width. This step can also be solved graphically using the map scale and a diagram equivalent to **Figure 8-2**.

2. Second step may be solved graphically by constructing a cross-section using the calculated true map outcrop width (w) as in **Figure 8-1**, or mathematically using

equation (1).

h) Inclined strata on sloping map surface, traverse taken perpendicular to strike.

1. Graphically construct the sloping map surface profile on the cross-section view. Then plot the dipping upper and lower contacts according to the outcrop width (w) obtained from the traverse. Note that (w) is the distance actually traveled on the sloping surface- not the distance between traverse endpoints measured from a map.



**Figure 8-4** : Scenario where dip and slope directions are the same for thickness calculation.

2. Trig formula will vary according to the relationship of the slope and dip directions. The best way is to inspect your graphical cross-section and decide whether the dip and slope angles are added or subtracted to form the correct geometry.

3. As an example, given that the dip and slope are inclined in opposite directions:

$\delta$  = dip angle

$\sigma$  = slope angle

$$\text{Sin}(\delta + \sigma) = \text{thickness} / (w)$$

(3)

$$\text{Thickness} = \text{sin}(\delta + \sigma) * (w) \quad (\text{See Figure 8-3})$$

If the dip and slope angles are inclined in the same direction

$$\text{Sin}(\delta - \sigma) = \text{thickness} / (w)$$

(4)

$$\text{Thickness} = \text{sin}(\delta - \sigma) * (w) \quad (\text{See Figure 8-4})$$

4. Note that in the special case where the slope surface is perpendicular to the stratigraphic contacts, the sum of the dip angle and slope angle will equal 90, therefore the outcrop width is equal to the true thickness.

i) Inclined strata on a sloping ground surface, traverse taken oblique to strike (this is the most general case).

- The first step is to plot traverse on map, and then plot the strike of the upper and lower contacts on the map. The slope distance component ( $w$ ) is then calculated by measuring the line perpendicular to the contacts.

$$w = \cos(\beta) * (w') \quad (\text{See Figure 8-2})$$

- After the outcrop width ( $w$ ) is calculated, a cross section view is constructed perpendicular to strike using the measured slope and true dip angles along with the ( $w$ ) value calculated in the above step. The true thickness can then be solved graphically or trigonometrically as described in previous steps above. Note that one should measure the slope angle in the direction of ( $w$ ), or estimate it from the topographic map before using it in the cross-section.

## II. Apparent thickness in a drill hole (Vertical apparent thickness or Depth)

a) It is often desirable to calculate the apparent stratigraphic thickness encountered in a vertical drill hole. In these calculations it is often assumed that the drill hole is perfectly vertical. The graphical value is then found by measuring on the cross-section the vertical distance between the upper and lower contacts.

b) Trigonometric

$$\cos(\delta) = t / d$$

$$d = t / (\cos(\delta))$$

(5)

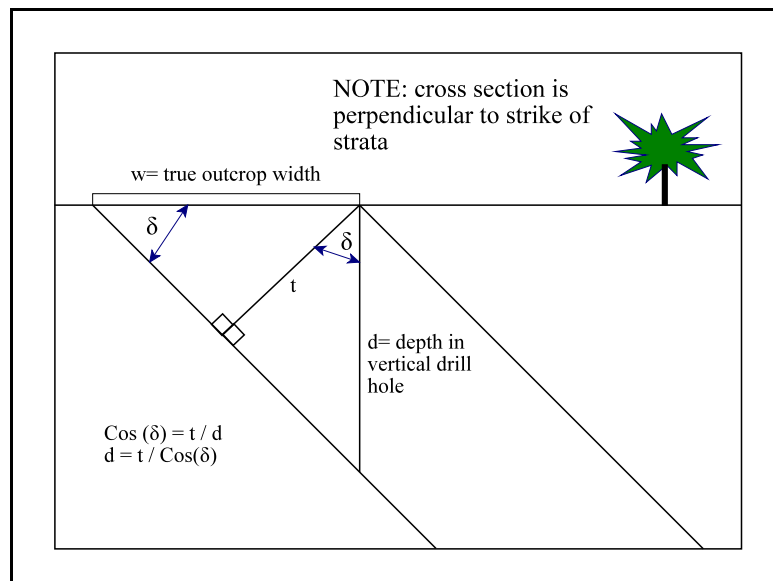


Figure 8-5 : Cross-section of depth problem.

## EXERCISE 8A: Thickness and Outcrop Width Problems

You may want to review the fundamentals of sin, cos, tan, etc. before reading the above pages in the lab manual. When you construct a cross-section for any of the below problems make sure that you label the direction of the line of cross-section (ex. NW-SE). These problems should be completed using graphical methods but check your answer with trigonometric equations.

Problem 1: A bed possesses a true dip amount and direction of  $55^\circ$ ,  $N0^\circ E$ . The surface of the ground is level, and the distance between the upper and the lower contacts of the bed measured perpendicular to strike is 250'. Find the thickness of the bed.

SCALE: 1" = 50 feet.

Problem 2: Find the thickness of a bed if the outcrop width between the upper and lower contacts is 175', as measured perpendicular to the strike direction. The ground surface slopes  $15^\circ$  opposite the true dip direction. The bed possesses a true dip amount and direction of  $35^\circ$ ,  $N90^\circ E$ . Find the true thickness of the bed.

SCALE: 1"=50 feet.

Problem 3: The attitude of a sandstone unit is  $N55^\circ E$ ,  $30^\circ SE$ . A horizontal traverse with a bearing of  $S20^\circ E$ , taken from the lower stratigraphic contact to the upper stratigraphic contact, measured 106 meters. What is the true thickness of the unit? Assume that the unit is not overturned by deformation.

SCALE: 1" = 75 meters.

Problem 4: A limestone formation is exposed along an east facing slope. Its attitude is  $N25^\circ W$ ,  $36^\circ SW$ . The traverse length from the lower contact to the upper contact along a bearing of  $N80^\circ W$  was 623 meters. The slope angle measured perpendicular to strike was  $15^\circ$ . Determine the true thickness of the limestone.

SCALE: 1" = 400 meters.

Problem 5: The width of the Red Mountain sandstone near Birmingham, Alabama, was found to be 175' measured along an  $S67^\circ E$  direction from a lower elevation to a higher elevation. The slope measured  $20^\circ$  perpendicular to the strike of bedding. The slope face exposed Red Mountain formation with the ends of the traverse being the contacts with an underlying limestone unit and an overlying shale unit. A strike and true dip of bedding are not available, but two apparent dips along bedding planes have been measured:  $33^\circ$ ,  $N47^\circ E$  and  $46^\circ$ ,  $S56^\circ E$ . Find the true thickness of the Red Mountain unit. Use any preferred method to solve for the strike and true dip of the unit.

SCALE: 1" = 100 feet

## EXERCISE 8B: Thickness and Outcrop Width Problems

You may want to review the fundamentals of sin, cos, tan, etc. before reading the above pages in the lab manual. When you construct a cross-section for any of the below problems make sure that you label the direction of the line of cross-section (ex. NW-SE). These problems should be completed using graphical methods but check your answer with trigonometric equations.

Problem 1: A bed dips at an angle of 35 degrees east. The surface of the ground is level, and the distance between the upper and lower contacts of the bed measured at right angles to strike is 200 feet. Find the thickness of the bed. SCALE: 1 inch = 50 feet.

Problem 2: Find the true thickness of a bed if the width of the outcrop between the upper and lower contacts is 150 feet, as measured at right angle to strike. The ground surface slopes 20 degrees opposite the dip. The bed dips 45 degrees east. SCALE: 1 inch = 50 feet.

Problem 3: The attitude of a sandstone unit is N65E, 35SE. A horizontal traverse with a bearing of S10E, taken from the lower to the upper contact, measured 126m. What is the true thickness of the sandstone bed? SCALE: 1 inch = 75m.

Problem 4: A limestone formation is exposed along an east-facing slope. It has an attitude of N15W, 26SW. The traverse length from the lower contact to the upper contact along a bearing of N90W measures 653m. The slope angle was +15 degrees (ascending) measured in the true dip direction. What is the true thickness of the limestone formation? SCALE: 1 inch = 400m.

Problem 5: The width of the Silurian Red Mt. Formation sandstone near Birmingham, Alabama, was found to be 150 feet measured in the S70E directional bearing beginning at the lower stratigraphic contact and terminating at the upper stratigraphic contact. This west-facing slope was found to have a topographic slope of 20 degrees. Also discovered along the traverse was an older limestone unit, the Ordovician Chickamauga limestone, and the younger Devonian Frog Mt. Sandstone. Although exposure was not sufficient for a direct strike and dip measurement, two apparent dips were recorded on the Red Mt. - Chickamauga contact: 24, N47E and 36, S26E. Find the thickness of the Red Mt. Formation. SCALE: 1 inch = 100 feet.

## LABORATORY 9: Outcrop Prediction

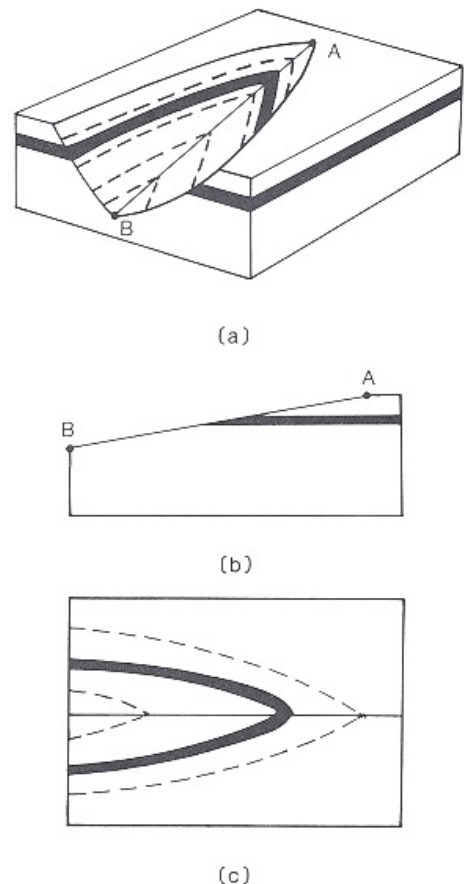
### I. Outcrop Prediction

- (A) Based on the assumption that contacts are perfectly planar, and are unaffected by faulting.
- b) To use this method you must be given the attitude of the planar surface, and at least one place where it is exposed in the map area. You must also have an accurate topographic base map. A 3-point problem can be solved for the attitude.
- c) The *outcrop prediction* method allows one to plot the location of the planar contact on the map if the above conditions are met.
- d) The procedure works by orthographically calculating the intersection of the plane with the ground surface as described by the contour lines.

### II. Special Cases

- a) *Horizontal attitude*: In this case the geological contacts are parallel to topographic contours (**Figure 9-1**). A geologic map can be constructed from the singular occurrence of exposed contacts if the area is unaffected by faulting.
- b) *Vertical attitude*: Topography has no effect; the contact line is drawn as a straight line parallel to the strike and passing through the position where it outcrops. In this attitude the outcrop width on the map is the same as the true thickness.
- c) *Rule of V (Geologic)*: Inclined strata will form a "V"-shape outcrop pattern that points in the dip direction if the contacts are cut by a stream valley (**Figure 9-2**; a, c, d).

The development of the "V" shape is inversely proportional to the dip angle, with a vertical (90 degree) dip producing no "V" offset (i.e. contacts remain straight regardless of topography; **Figure 9-2b**). Note that the rule of V's holds true only when the dip of the strata is greater than the slope of the valley, however, topographic relief is rarely so large that stream gradients are greater than true dip. Unless



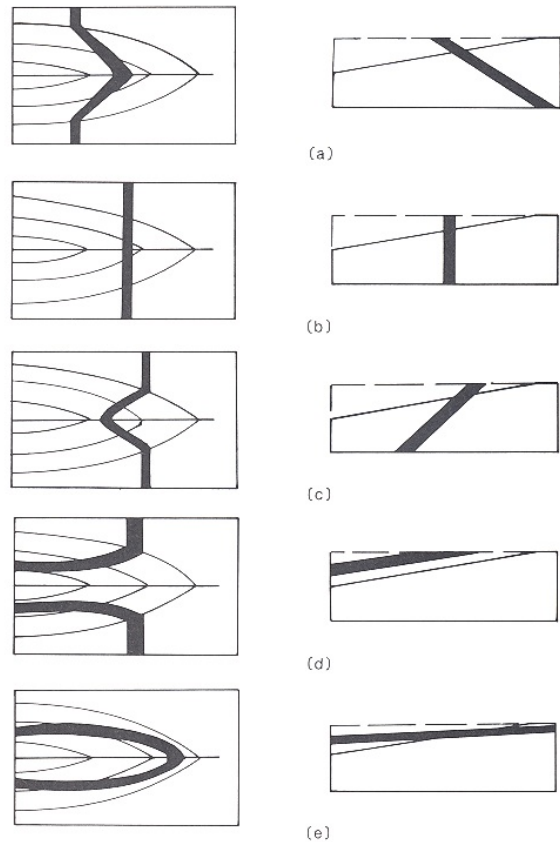
**Figure 9-1** : Example of horizontal contacts exposed in a valley.

regional dip is very small and topographic relief is large so that the valley slope is greater than the dip (as in **Figure 9-2e**), it is safe to assume the geologic rule of V's.

NOTE: It is important to distinguish the topographic "Rule of V's" from the geologic "Rule of V's":

1. Topographic: topographic contour lines will form a "V" when they cross a valley that point in the uphill direction of the valley. A corollary to this is that the "V" of contours must point in the upstream direction of a stream valley.

2. Geologic: planar geologic contacts form a "V" geometry when they cross a topographic valley that points in the true dip direction of the contact. Shallow true dips form exaggerated "V" patterns, whereas steep dips form a barely recognizable "V" pattern. Vertical dips will have no "V" pattern because contact lines remain perfectly straight regardless of topography. Horizontal contacts (dip=0) remain parallel to topographic contacts.



### III. General Solution for Outcrop Prediction

a) Given topographic map with location of exposure, and the attitude of the exposed contact. Assuming that the contact is planar we can proceed with the outcrop prediction.

b) Steps for solving problem:

1. Construct a fold line (FL) perpendicular to the strike of the contact and located to one side of the map. Below the fold line construct a grid to scale that conforms to the topographic contour interval. The grid lines are parallel to the original fold line. The grid lines have been constructed in **Figure 9-4** below the map. Note that the grid lines are labeled 100-140 because these values represent the topographic relief of the map.

2. The elevation of the exposed contact should be taken from the contour map. This point is projected parallel to the strike of the contact until it intersects the fold line.

At the fold line, continue the projected line downward until it intersects the matching grid elevation. Plot this point. In the **Figure 9-4** example, the position and attitude of the exposed outcrop is indicated by the strike and dip symbol.

3. Through the point identified in step (2) above, plot the trace of the contact dipping at the true dip angle in the grid profile. Make sure that the dip direction is correct. Note those locations where the contact intersects an elevation grid line. The projections of these intersections parallel to strike and to the map view represent structure contour lines of a specific elevation. Label these lines (which have a constant spacing) with the appropriate elevation number.

4. From each intersection of an equivalent structure contour and topographic contour from step (3), plot points that represent the outcrop geometry for that surface. Mark these locations with dots as has been done in **Figure 9-4**. Note that a certain amount of interpolation can be done to get better resolution of the contact position.

5. Using the pattern of dots trace the contact of the layer on the map surface. Remember the rule of "V" when constructing the contact. This has been done in **Figure 9-4**.

c) Note that if the thickness of the layer is given, the entire outcrop belt can be plotted for that particular unit since both the upper and lower contacts can be plotted. This, of course, works correctly only if the assumption that the unit is tabular is valid. Use the map scale to plot the other contact on the cross-section grid. This line will be parallel to the first contact plotted. Wherever the contact crosses elevation grid lines yields a position where the strike line of the contact is at the same elevation as one of the contour intervals. As in steps (4) and (5) these strike lines (structure contours) of known elevation can be projected to the map and therefore define points where the contact outcrops. **Figure 9-5** displays the outcrop prediction for the above example if the stratigraphic thickness was 12.8 meters. The structure contours for the lower stratigraphic contact are plotted as dashed lines to distinguish them from those of the upper contact.

D) As with most graphical solutions to structural problems, the outcrop prediction problem can also be managed mathematically. Consider the cross-sectional view of the problem in **Figure 9-4**. The spacing between adjacent structure contours is always the same, and is controlled by the equation:

$$\text{Tan (Dip angle)} = (\text{Contour Interval}) / (\text{Structure Contour Spacing})$$

$$(\text{Structure Contour Spacing}) = (\text{Contour Interval}) / \text{Tan(Dip Angle)}$$

Using the example in **Figure 9-4** would yield:

$$(\text{Structure Contour Spacing}) = (10 \text{ m}) / (\text{Tan } 40^\circ)$$

$$\text{Structure Contour Spacing} = 12 \text{ m}$$

You would then draw parallel lines to the initial strike line spaced at 12 meter intervals perpendicular to strike. These structure contours would decrease in elevation in the dip direction, just as they do in **Figure 9-4**. Using this method you can avoid the time-consuming task of constructing the cross-sectional grid.

Structure contours for the bottom of the bed in the example can be constructed mathematically also. The spacing between adjacent structure contours for the bottom of the bed is exactly the same as the top because both surfaces have the same dip (see **Figure 9-5**). The unknown value is the offset of structure contours of the same elevation for the top and bottom of the bed. In the **Figure 9-5** example this value was calculated graphically by constructing the cross-section to scale. However, the problem can also be solved with trig:

$$(\text{Offset}) = (\text{Thickness}) / (\text{Sin (Dip Angle)})$$

Therefore, for the **Figure 9-5** example:

$$\text{Offset} = (12.8 \text{ m}) / (\text{Sin } 40)$$

$$\text{Offset} = 19.3 \text{ m}$$

The 110 meter bottom structure contour is offset 19.3 meters from the 110 meter top structure contour in the “up-dip” direction. In this case the offset is to the west. You may need to sketch the problem in profile to verify the direction of the offset when solving mathematically. With the initial 110 meter structure contour plotted, the other structure contours on the bottom contact are spaced 12 meters apart with the elevation decreasing in the dip direction, just like the structure contours for the top of the bed. The spacing between structure contours is the same because both the top and bottom surfaces of the bed dip at the same angle.

If the outcrop of the structural plane occurs at a topographic elevation equal to a contour interval, the structure contour spacing can be used from that point to construct all necessary structure contours as a set of parallel lines (see **Figure 9-4**). If a contact can be traced on a map surface from aerial photography or from a geological map the "starting" structure contour can be set to where a topographic contour crosses the contact line. However, this may not be possible so the relationship:

$$\text{Tan (Dip Angle)} = (\Delta y)/(\Delta x)$$

Can be used to calculate the exact offset from the control point to start the structure contour. For example, assume that the map topographic contour interval is 20 feet, and a bedding plane contact with attitude 330, 55 SW is discovered at 707 feet elevation. A 720 topographic contour is near the outcrop so the offset from the outcrop to the 720 structure contour on the contact is needed. First you should realize that the offset direction from the outcrop is in the 030 direction because that is perpendicular to strike and in the "up-dip" direction (i.e. elevation is gained from 707 to 720). The amount of map distance between the outcrop and 720 structure contour is calculated from:

$$\begin{aligned}\text{Tan}(55) &= 13/x \\ x &= 13/\text{Tan}(55) = 9.1 \text{ feet}\end{aligned}$$

Where x is the offset distance from the outcrop to the 720 structure contour. From this offset point the 720 structure contour can be drawn as a straight line striking 330. Where this line intersects the 720 topographic contour would generate outcrop control points.

E) Another geometrical quantity that may prove useful in outcrop prediction is the vertical distance between the upper and lower contacts in **Figure 9-5**. You may recall this geometry from the chapter on thickness calculations (see **Figure 8-5**):

$$d = t / (\cos (\delta))$$

Where d is the vertical distance between the upper and lower contacts, t is the thickness of the unit, and  $\delta$  is the dip angle. For the example problem the "d" value would be:

$$d = 12.75\text{m} / (\cos(40)) = 16.6\text{m}$$

Therefore, because in **Figure 9-5** we know that the given strike and dip control point on the top planar contact exists at an elevation of 110m, there must also exist a point on the bottom contact directly below this map location at an elevation = 110m - 16.6m = 93.4m. This value can be important- for example if you have the equation for the upper contact plane in the form:

$$z = c_0 + x * c_1 + y * c_2$$

where z is the elevation of the plane, and x and y are the map coordinates. If the upper contact plane in this example conformed to the equation:

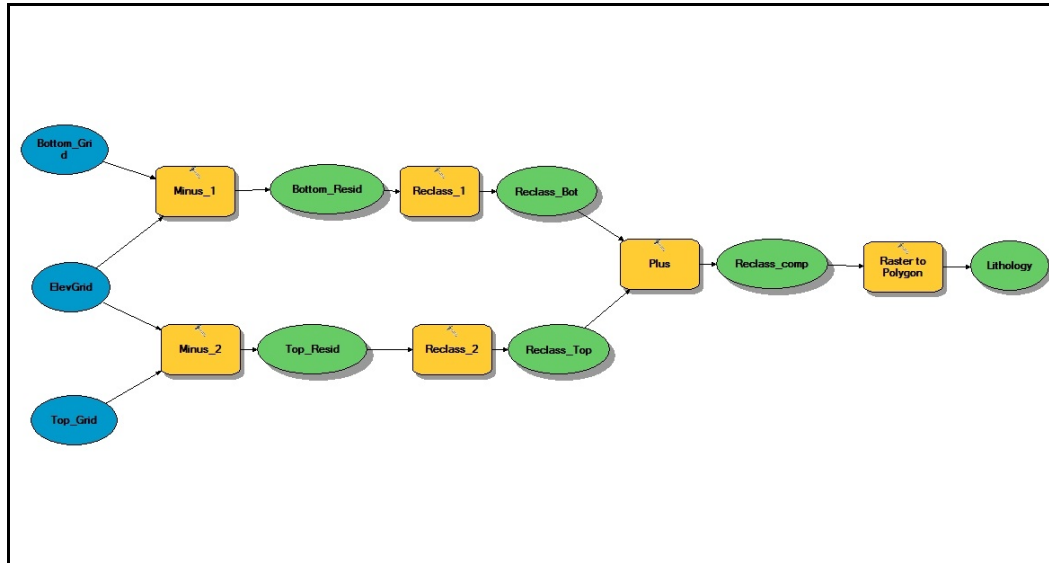
$$z = 419798.3 + x * -0.8391 + y * -1.490\text{e-}8$$

then the equation for the bottom contact must be:

$$z = 419781.7 + x * -0.8391 + y * -1.490\text{e-}8$$

Note that the only difference in the bottom contact equation is the 16.6m subtracted from the constant term (c0) in the equation for the top contact - i.e. an elevation shift along the z axis. The c1 and c2 coefficients don't change because the top and bottom contacts have the same attitude.

#### IV. GIS Generated Outcrop Prediction



**Figure 9-3** : Graphical flow chart of the ArcGIS procedure for constructing an outcrop prediction.

a) Geographic Information Systems (GIS) or Computer-Aided Design (CAD) computer applications can be used to quickly and accurately generate outcrop prediction maps as long as an elevation raster is available for the topographic surface. If a topographic survey has been completed in an area an elevation grid can be interpolated from the survey if necessary with GIS tools.

b) The **Figure 9-3** diagram displays the analysis flowchart for producing an outcrop prediction with ArcGIS 10.x using elevations grids for the top contact, bottom contact, and topographic surface respectively (Top\_Grid, Bottom\_Grid, and ElevGrid in graphic). All three of the grids should overlay the same map extents. The ElevGrid can be constructed with the Spatial Analyst “Interpolate Surface > Spline” tool to create the elevation raster from the survey points used to draw the topographic contours in **Figure 9-5**.

The top and bottom grids are assumed to be planar and are produced with a Python program “PlaneTrendSurf.py” (see links to GIS exercise below). The input into the python program is:

-----  
Line 1. trend and plunge degrees of the true dip vector (trend in azimuth format) (ex. 90.0, 40.0).  
Line 2. Elevation (Z value) of the measured attitude. (ex. 110.0).  
Line 3. "X,Y" coordinates of the position of the attitude measurement (ex. "500165.0, 3000085.0").  
Line 4. SW corner (lower left) "X,Y" coordinates of the calculated raster image. (ex. "500000.0, 3000000.0")  
Line 5. "Columns,Rows" in calculated raster (ex. "195, 145").  
Line 6. Grid spacing between rows and columns of raster grid (ex. "1.0").  
-----

Output: ESRI raster file with following structure:

Line 1: "ncols=" {number of columns in raster grid}  
Line 2: "nrows=" {number of rows in raster grid}  
Line 3: "xllcorner=" {x coordinate of the lower left (SW) corner of the grid}  
Line 4: "yllcorner=" {y coordinate of the lower left (SW) corner of the grid}  
Line 5: "cellsize=" {cell size spacing between columns and rows}  
Line 6: "nodata value=" {value that represents no data at grid node}  
Line 7: 1<sup>st</sup> z value  
Line 8: 2<sup>nd</sup> z value  
Line (ncols \* nrows + 6) : (ncols \* nrows) z value  
-----

In this example problem the top contact input file (“ProbEx\_top\_in.txt”) for “PlaneTrendSurf.py” would be formatted in “Notepad” as below:

-----  
Line 1: 90.0, 40.0  
Line 2: 110.0  
Line 3: 500165.0, 3000085.0  
Line 4: 500000.0, 3000000.0  
Line 5: 195, 145  
Line 6: 1.0  
-----

The bottom contact input text file for “PlaneTrendSurf.py” program would be:

```
-----
Line 1: 90.0, 40.0
Line 2: 93.4
Line 3: 500165.0, 3000085.0
Line 4: 500000.0, 3000000.0
Line 5: 195, 145
Line 6: 1.0
-----
```

Note that the only difference between the above two input files is the different elevations on line 2.

Remember that the output of the “PlaneTrendSurf.py” program is a text file (in this example “ProbEx\_top\_grd.txt” and “ProbEx\_bot\_grd.txt”) that has to be converted to a raster file in ArcMap with the “ASCII to Raster” tool.

c) The basis of the ArcGIS method uses the “Grid Math” tool to subtract the topographic grid from the top/bottom contact grids. In the **Figure 9-3** graphic this is represented by the “Minus\_1” and “Minus\_2” operations. Note that both of the grid subtractions use the elevation grid “ElevGrid” as the 2<sup>nd</sup> operand. After the grid subtraction the following is true for the two output residual grids “Bottom\_Resid” and “Top\_Resid”:

Grid Node Value	Geometry
> 0.0	Contact is above topographic surface therefore the strata below the contact is exposed.
= 0.0	Contact outcrops at this point.
< 0.0	Contact is below topographic surface therefore the strata above the contact is exposed.

Conveniently the default listing format in the ArcGIS table of content window is to list the grid node values in descending order (lower values first, higher values last) so negative values are on top and positive values on the bottom so this replicates the stratigraphic order.

d) The “Reclass\_1” and “Reclass\_2” operations simplify the residual grids into the following :

Grid Node Value	Reclassified Value
< 0.0	1 (strata above contact exposed)
>= 0.0	2 (strata below contact exposed)

Top Grid	+	Bottom Grid	=	Composite Grid
1		1		2=younger strata exposed

2	1	(strata above top and bottom contact) 3=intermediate strata exposed (strata below top contact, above bottom contact)
2	2	4=older strata exposed (strata below top contact, below bottom contact)

Note that the condition of the top grid node = 1 and the bottom grid = 2 at the same map position is not possible if the top contact is structurally above the bottom contact. In the **Figure 9-3** diagram the “Plus” operations adds the two reclassified grids to produce “Reclass\_comp” composite grid. In this grid the strata above the top contact will have a “2” value, the intermediate strata between the top and bottom contact will have a “3” value, and strata below the bottom contact will have a “4” value. This grid represents a geologic map of the map area based on the top and bottom contacts.

e) The last “Raster to Polygon” procedure converts the raster to a polygon feature class in case the user needs the geologic map in that format. It is easier to format and do area and volume calculations with a polygon feature class in ArcGIS. The final result layout in ArcGIS is displayed in **Figure 9-6**.

f) The user should note that the “Raster Math” procedures used in the **Figure 9-3** diagram requires either the Spatial Analyst or 3D Analyst extensions in ArcGIS 10.x.

g) In the above example the top and bottom contact were assumed to be planar, however, this is not a requirement for the above procedure to produce a geologic map. As long as the top and bottom contacts actually intersect the topographic surface the method should work on top and bottom contact grids produced by trend surface or other mathematical tools.

h) In the above example the terms “top” and “bottom” contacts refer to the structural top and bottom contacts, not the stratigraphic top and bottom. If the strata in the above example had been overturned the structural top contact would have been the stratigraphic bottom and vice versa. If this had been the case the above procedures would have been the same except that on the final map (**Figure 9-6**) the “Younger” and “Older” stratigraphic labels would be switched.

i) If you have had some experience with ArcGIS you may recognize the diagram in **Figure 9-3** as a “model” designed with the ArcGIS “Model Builder”. These diagrams are much more than a graphical flowchart- they can actually execute all of the steps in the flowchart using the indicated input sources. If you know how to use the model builder you can use it to automate the solution of any of the problems in this chapter.

j) For a step-by-step document outlining the above ArcGIS example with screen shots please

refer to the below link:

[http://www.usouthal.edu/geography/allison/gy461/gy461\\_project\\_resources.htm](http://www.usouthal.edu/geography/allison/gy461/gy461_project_resources.htm)

Look for the “Outcrop Prediction Project > Example Problem Strting Files” section on the above web site. Download the following files:

1. Example Problem documentation {click on link to download documentation}
2. OPexample\_start.mdb {starting geodatabase file for example problem; click on link to download}
3. PlaneTrendSurf.py {right-click on link to “save as” the file to your working folder}

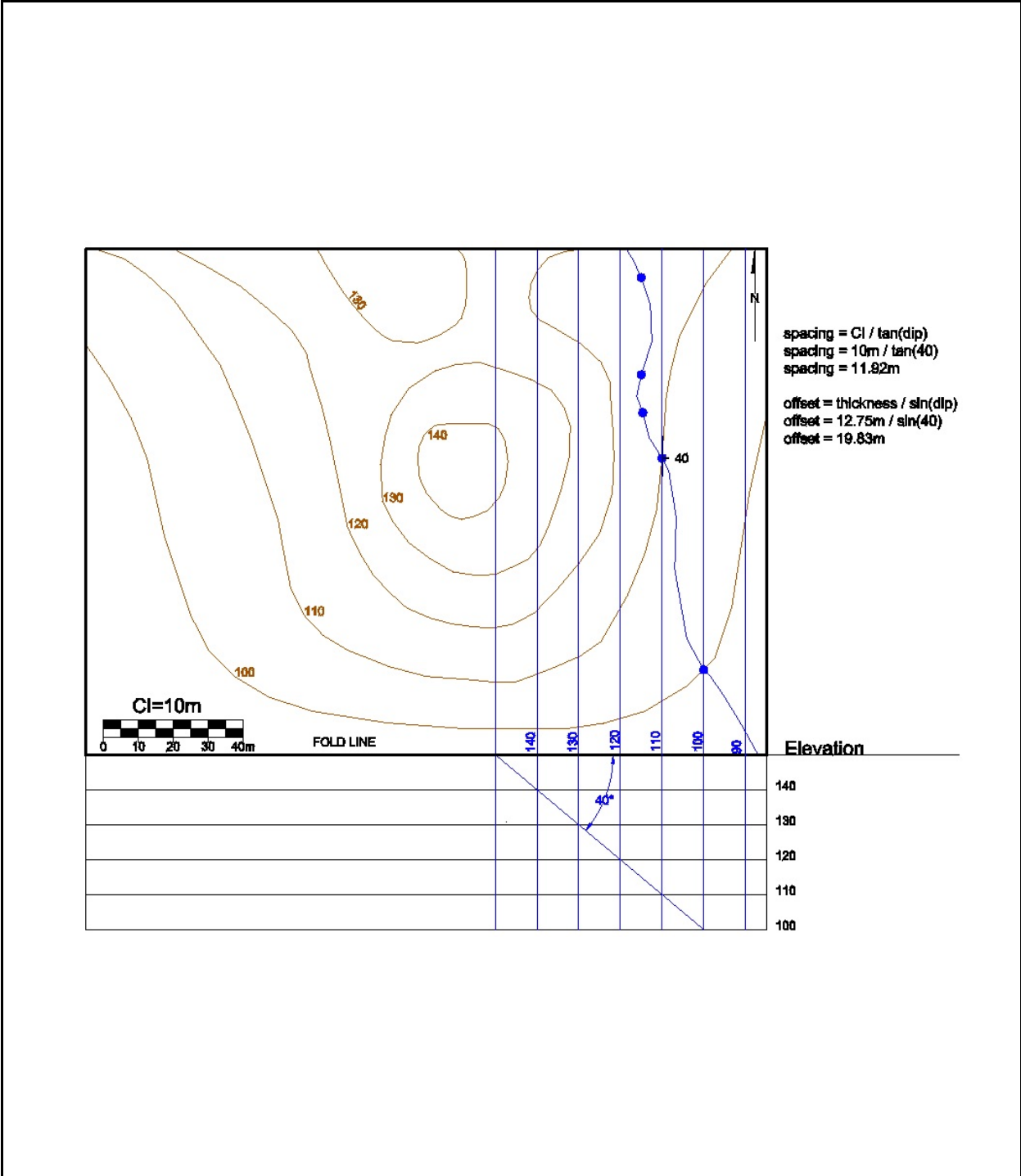


Figure 9-4 : Initial setup of outcrop prediction example problem.

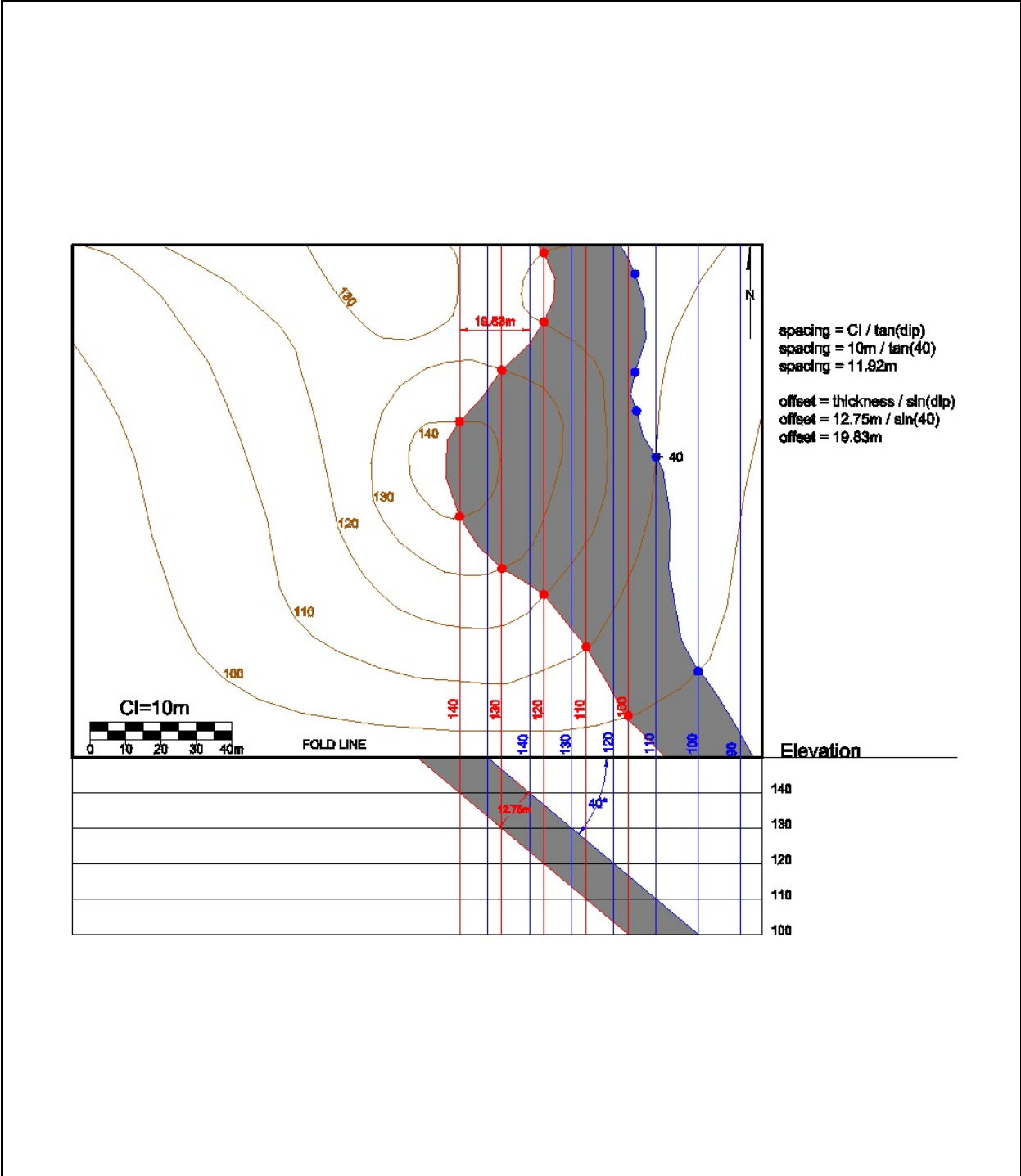
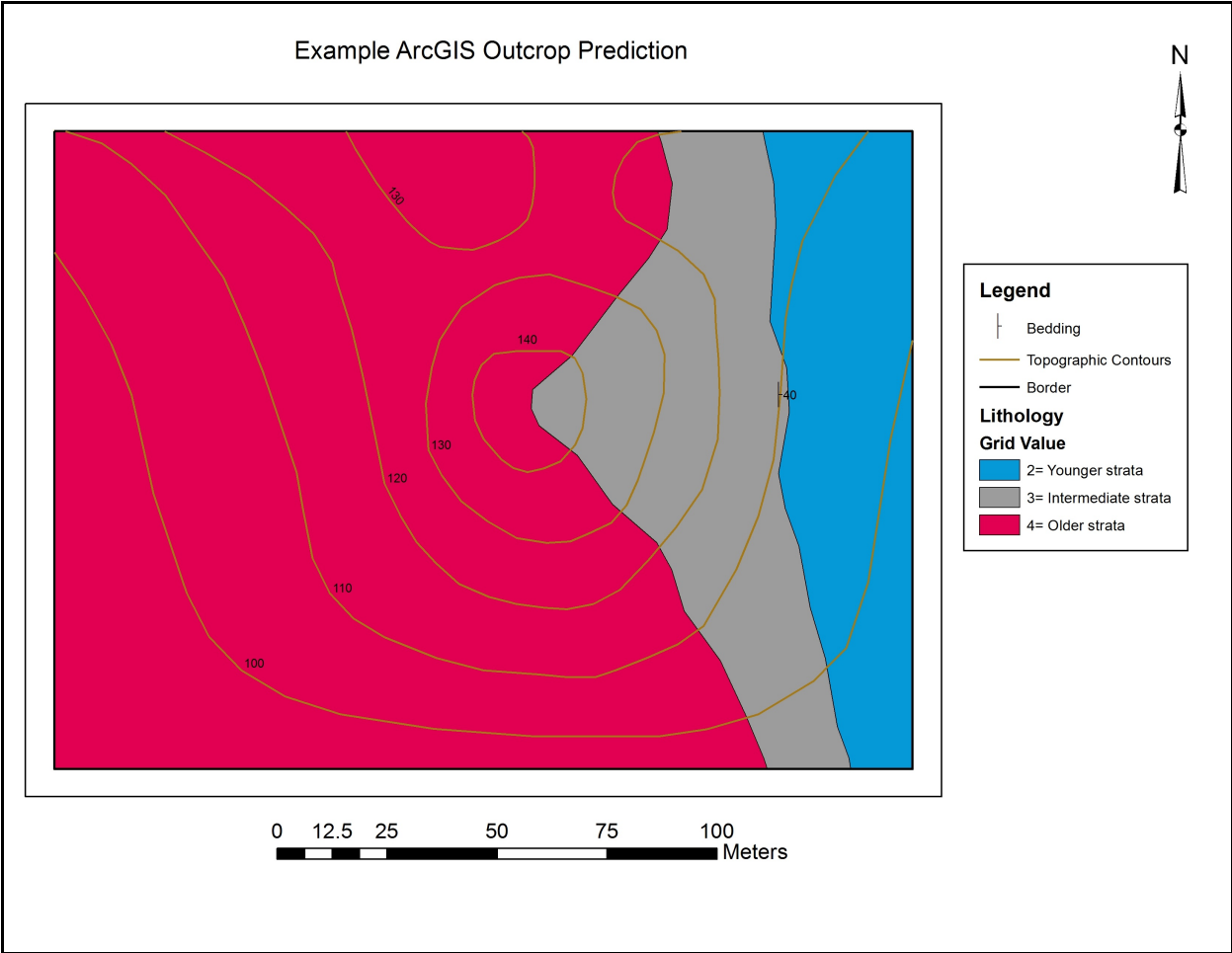


Figure 9-5 : Final solution of example outcrop prediction problem.



**Figure 9-6 :** ArcGIS generated version of example outcrop prediction.

## EXERCISE 9A: Outcrop Prediction

When constructing your problem, you should copy the base map contours, map boundary, etc., onto a sheet of your drafting paper with a rapidograph, or by xeroxing onto drafting paper. Be aware that reproduction of this laboratory manual often distorts the scale of maps used for problems. You should check for this eventuality, and if the distortion is significant use the scale bar of the map for the problem construction. Those of you who have had training with CAD or GIS applications can generate final maps with software. In the below problems it is important to remember the following definitions:

- **Stratigraphic Contact:** refers to the original stratigraphic sequence and, therefore, gives relative age information. For example, if the contact of a sedimentary or volcanic unit is referred to as the upper stratigraphic contact, then you can be sure that the contact is the original top of the unit and that rocks adjacent to that contact are younger than those adjacent to the other contact of the unit.
- **Structural Contact:** refers to the present position of the contact. For example, the upper structural contact is simply the present contact that is vertically uppermost in the current structural position. Note that in an overturned sequence of strata that the upper structural contact of a unit is the stratigraphically lower (oldest) contact. Also note that if a sequence of sedimentary strata is vertical (dip = 90), there is no structural upper and lower contact, however, there is still a stratigraphic upper and lower contact.

Problem 1: The stratigraphic upper (younger) contact of a geological formation outcrops at points X, Y, and Z on the map in **Figure 9-7**. The thickness of the bed is 50 feet. Assume that the formation is not overturned and is planar. Draw both the upper and lower stratigraphic contacts on the map. Color the formation red, the stratigraphically older formation green, and the stratigraphically younger formation blue.

Contour Interval = 50 feet

Problem 2: The upper stratigraphic contact of a sandstone bed crops out at points A, B, and C, on the map in **Figure 9-8**. The lower stratigraphic contact of the sandstone outcrops at point D. Determine the strike and dip and draw in both stratigraphic contacts on the map. Color the sandstone red, the stratigraphically older unit green, and the younger unit blue. What is the thickness of the sandstone bed?

Contour Interval = 10 feet

Problem 3: The outcrop pattern of the stratigraphic top contact of a Cretaceous formation is displayed on the map in **Figure 9-9**. Find the strike and dip of the contact. Copy the map boundary and contour information onto your paper so that it is included with your solution. On this base map plot the structure contours using the contour interval of 200 feet. Assume that the Cretaceous is 200 feet thick and that the lower contact of the Cretaceous is parallel to the upper contact. Calculate the position of the lower Cretaceous contact based on this thickness. Plot the structure contour lines for the lower stratigraphic contact and label with a contour interval of 200 feet. Use continuous structure contour lines for the top of the formation, dashed contour lines for the bottom contact.

Contour Interval = 200 feet

Problem 4A: Copy the base map and contacts from Problem 3 onto a separate sheet of paper. Fossils collected several feet structurally above the upper Cretaceous contact are Tertiary. Fossil data collected from all sedimentary rocks structurally below the Cretaceous strata are Triassic. Points 1, 2, and 3 on the map in **Figure 9-9** are outcrops of the upper structural contact of a basalt flow, and point 4 is the outcrop of the lower structural contact of the same flow. At point 4 the basalt flow was vesicular. At points 1, 2, and 3, the strata structurally above the basalt flow appears to have been affected by contact metamorphism. What is the attitude of the basalt flow? What is the thickness of the basalt flow? Color the outcrop area of all Triassic volcanic rocks black. Color all Tertiary sedimentary rocks blue, Cretaceous sedimentary rocks red, and Triassic sedimentary rocks green.

Problem 4B: On a separate sheet of paper describe in order of oldest to youngest all of the geological events represented on your map. Label each event sequentially with a number, starting with (1) for the oldest. Be sure to use all time constraints available in the above problem description. If you must explain any contacts on your map with a fault or unconformity, use a thick line for fault contact (suggest your #2 pen), and a hachured line of normal thickness (#0 pen) for an unconformable depositional contact. Hachures on an unconformable contact always lie on the side of the contact occupied by relatively younger strata.

## EXERCISE 9B: Outcrop Prediction

For this exercise we will use ArcGIS 10.x to process the outcrop prediction given some beginning digital map data. You will need access to a GIS lab with ArcGIS installed on it. We will also use a Python program in the “PythonWin” programming environment so this should be installed also. Currently these applications are installed on all of the workstations in the GIS lab rooms LSCB 333 and 146. The starting files are located at:

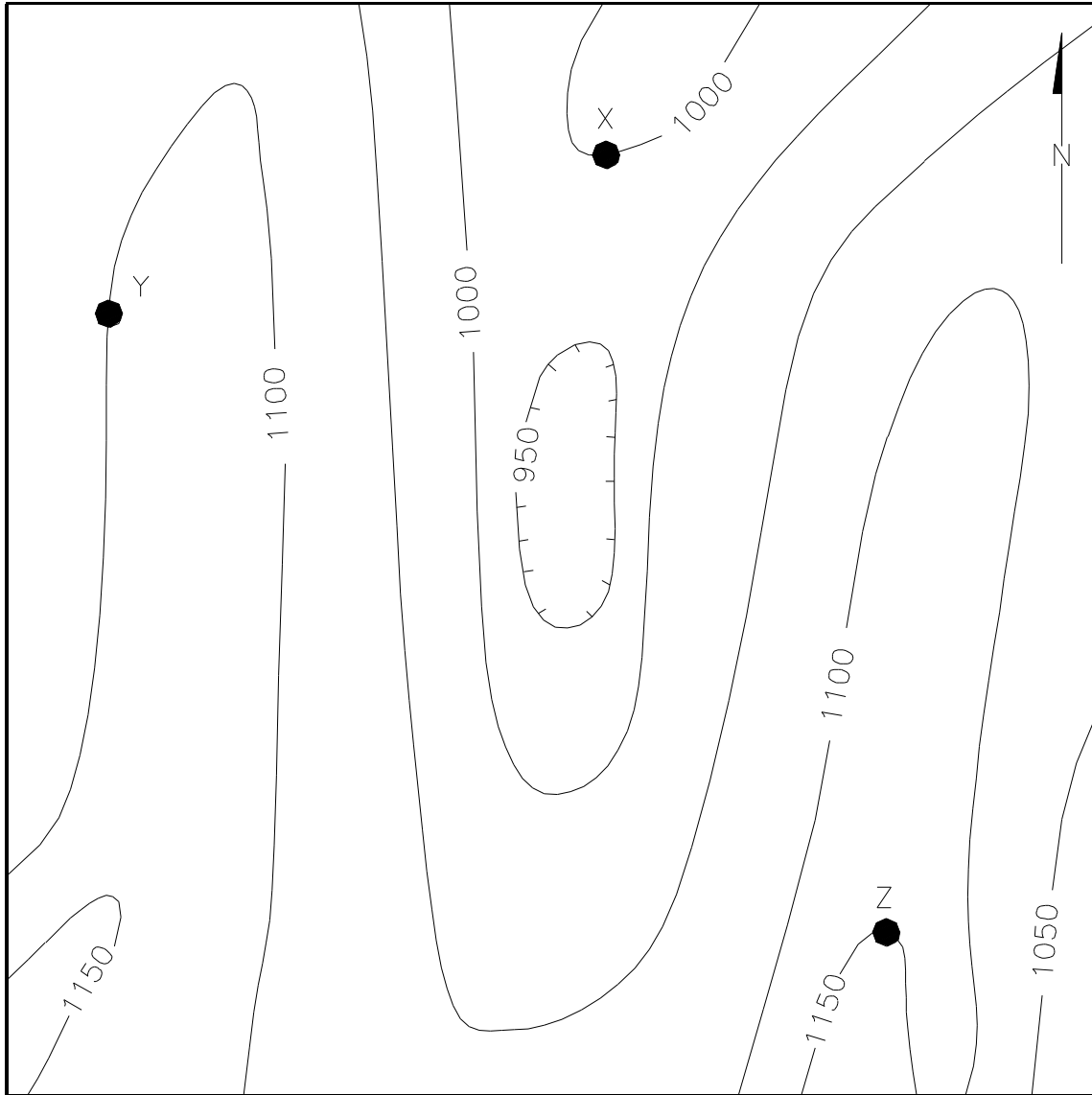
[http://www.usouthal.edu/geography/allison/gy461/gy461\\_project\\_resources.htm](http://www.usouthal.edu/geography/allison/gy461/gy461_project_resources.htm)

Look for the "Outcrop Prediction Project" Heading in the list of projects. Work through the example problem in the above section before attempting the below problems.

Problem 1: (see “Problem 1 documentation” file).

Problem 2: (see “Problem 2 documentation” file). The USA campus topographic contour map in **Figure 9-10** is included for reference.

PROBLEM 1  
SCALE: 1 inch = 100 feet  
C. I. = 50 feet



0 100 ft.

Figure 9-7 : Topographic map for problem 1.

PROBLEM 2  
SCALE: 1" = 1000 FEET  
CONTOUR INTERVAL = 10 FEET

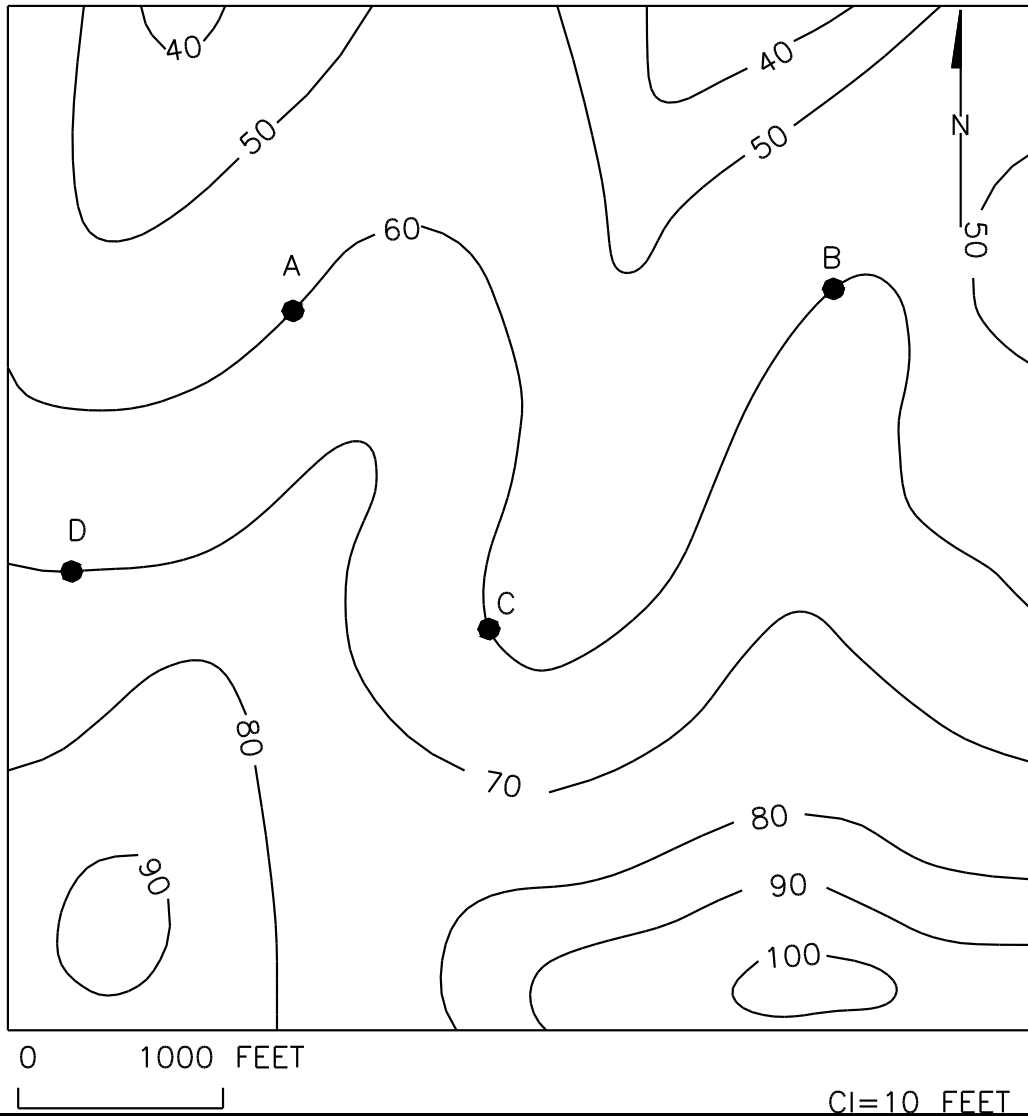


Figure 9-8 : Topographic map for problem 2.

PROBLEM 3  
SCALE: 1"=1000 FEET

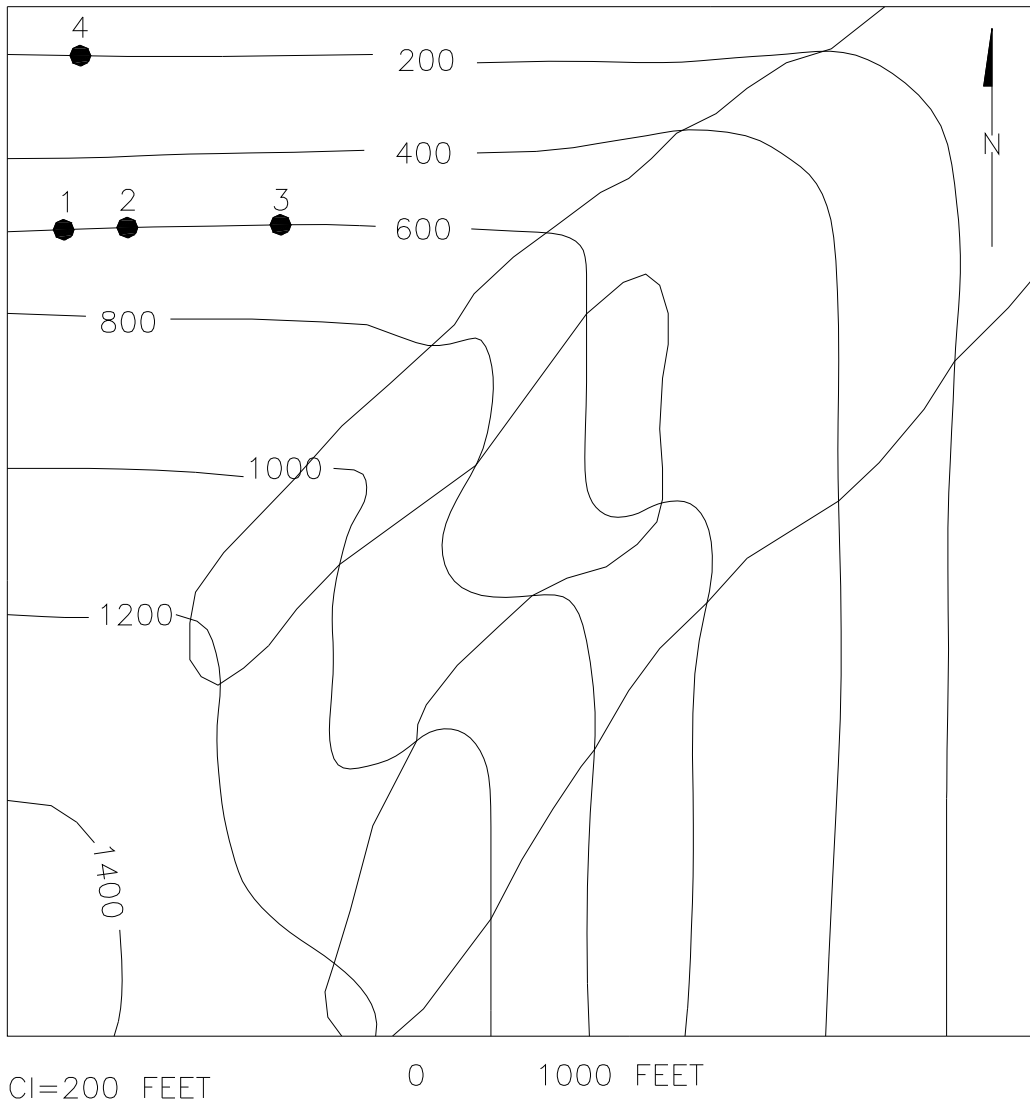
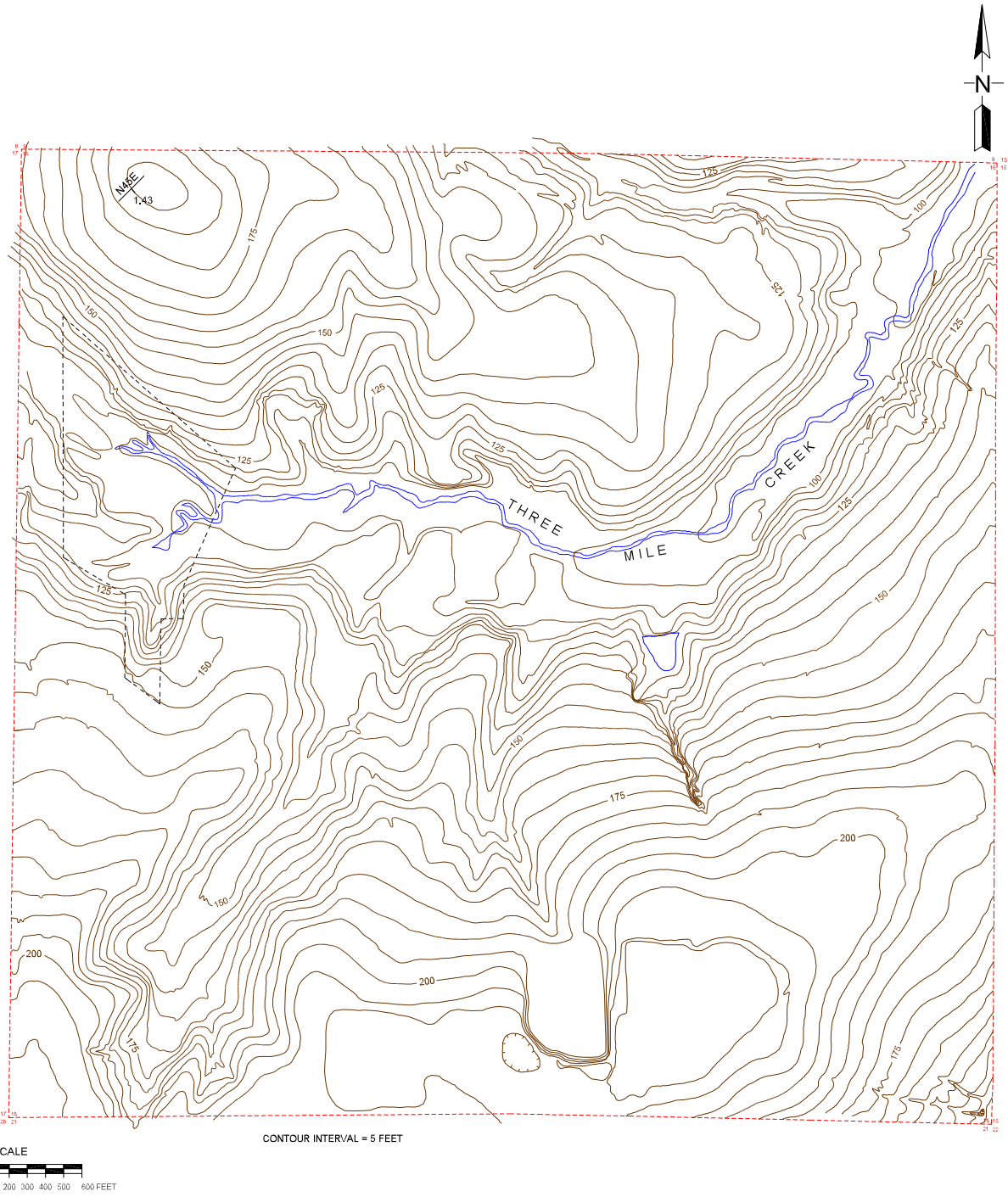


Figure 9-9 : Topographic map for problems 3 and 4.



**Figure 9-10** : USA campus topographic map.

## LABORATORY 10: Stereographic Statistical Techniques

### I. Introduction

a) Statistics can be used with the stereonet as a predictive tool. Usually the structural geologist is most interested in patterns on the stereonet that indicate a type of structure, such as a fold. In addition statistics can define a *confidence region* on the stereonet that contains a probability value that predicts how likely future measurements would fall inside the region.

b) There are several types of geometric patterns that are indicative of structures:

1. *Point cluster*: a cluster of points indicate that most of the data have approximately the same attitude. This is true of linear data or poles to planes. Solving for the *least-squares* or *best-fit vector* to the data set gives the "center of gravity" of the data (i.e. *mean vector*)

2. *Cylindrical girdle*: points that are aligned along a great circle represent vectors that are contained within a common plane in three dimensions. Since poles to a folded surface, such as bedding, have this property this type of distribution is termed cylindrical because the folded surface is approximated by a section of a cylinder. The pole to the girdle plane is the hinge attitude of the fold. The girdle is also the great circle arc along which the *interlimb angle* can be measured since it represents the plane perpendicular to the hinge. A statistical least-squares solution will yield the attitude of a geometric plane that minimizes the deviations of the data from the girdle great circle.

3. *Conical distribution*: a conical distribution is representative of vectors which fall along a small circle. These distributions can be produced by several different mechanisms. Some folds are not cylindrical but are instead inherently conical in shape. Conical folds will "die out" along the axial trace. Originally cylindrical folds may become conical after being re-folded by later deformation. Lineations that exist in a rock mass that is later affected by cylindrical *parallel folding* will be deformed into a small circle distribution if, as is likely, their original attitude was not perpendicular to the later fold axis. Solving for the least-squares conical surface for data that has been affected by this type of deformation yields a conical axis and a *K angle*. The K angle is also termed the  $\frac{1}{2}$  *apical angle*. This is the angular arc from the cone axis to the least-squares conical surface.

c) The mathematical equations that calculate statistical parameters must use data in the form of *directional cosines*. The attitude of geometrical least-squares elements are also solved for in the form of directional cosines. Note that any directional cosine can be checked for validity by the following relationship:

$$\cos(\alpha)^2 + \cos(\beta)^2 + \cos(\gamma)^2 = 1.0$$

where  $\alpha$ ,  $\beta$ , and  $\gamma$  are the directional angles of the vector.

## II. Least-squares Vector of Ramsay (1968)

a) Equations for the least-squares vector solve for the directional cosines of the vector:

$$F = \sqrt{\sum_{i=1}^n [(\cos \alpha_i)^2 + (\cos \beta_i)^2 + (\cos \gamma_i)^2]}$$

where  $\alpha_i$ ,  $\beta_i$ , and  $\gamma_i$  are the directional angles for the data set with summation from  $i = 1$  to the “*n*th” data element.

$$\cos(\alpha_v) = \frac{\sum_{i=1}^n \cos(\alpha_i)}{F} \quad \cos(\beta_v) = \frac{\sum_{i=1}^n \cos(\beta_i)}{F} \quad \cos(\gamma_v) = \frac{\sum_{i=1}^n \cos(\gamma_i)}{F}$$

where  $[\alpha_v, \beta_v, \gamma_v]$  represent the attitude of the least-squares vector.

## III. Least-squares Cylindrical Plane of Ramsay (1968)

a) Equations for the least-squares cylindrical plane are necessarily more complex than those for the vector, therefore, to simplify the below equations let:

$$\begin{aligned} l &= \cos(\alpha_i) \\ m &= \cos(\beta_i) \\ n &= \cos(\gamma_i) \end{aligned}$$

therefore, whenever  $[l, m, n]$  are present in the below formulae they actually represent  $[\cos(\alpha), \cos(\beta), \cos(\gamma)]$  for the “*i*th” data vector element respectively:

$$\text{let } E = \Sigma(l^2)\Sigma(m^2) - \Sigma((lm)^2)$$

$$A = \frac{\Sigma(lm)\Sigma(mn) - \Sigma(nl)\Sigma(m^2)}{E}$$

$$B = \frac{\Sigma(lm)\Sigma(nl) - \Sigma(mn)\Sigma(l^2)}{E}$$

$$C = \frac{A}{\sqrt{1 + A^2 + B^2}}$$

$$\cos(\alpha_p) = \frac{A}{\sqrt{1 + A^2 + B^2}}$$

$$\cos(\beta_p) = \frac{B}{\sqrt{1 + A^2 + B^2}}$$

$$\cos(\gamma_p) = \frac{1}{\sqrt{1 + A^2 + B^2}}$$

where  $[\alpha_p, \beta_p, \gamma_p]$  represent the directional angles of the hinge of the cylindrical fold, which is also the pole to the least-squares plane. All of the summation symbols above are for  $i = 1$  to  $n$  data. This is also true for all following summation symbols.

#### IV. Least-squares Conical Surface of Ramsay (1968)

a) Solving for the least-squares conical surface requires the extraction of determinants from the below matrices. The notation of  $(l, m, n)$  is equivalent to that used in Ramsay's method for a cylindrical fit. "N" is equivalent to the number of data observations:

$$D = \begin{matrix} \Sigma(l^2) & \Sigma(lm) & \Sigma(l) \\ \Sigma(lm) & \Sigma(m^2) & \Sigma(m) \\ \Sigma(l) & \Sigma(m) & N \end{matrix}$$

$$D_A = \begin{matrix} -\Sigma(ln) & \Sigma(lm) & \Sigma(l) \\ -\Sigma(mn) & \Sigma(m^2) & \Sigma(m) \\ -\Sigma(n) & \Sigma(m) & N \end{matrix}$$

$$D_B = \begin{matrix} \Sigma(l^2) & -\Sigma(ln) & \Sigma(l) \\ \Sigma(lm) & -\Sigma(mn) & \Sigma(m) \\ \Sigma(l) & -\Sigma(n) & N \end{matrix}$$

$$D_C = \begin{matrix} \Sigma(l^2) & \Sigma(lm) & -\Sigma(ln) \\ \Sigma(lm) & \Sigma(m^2) & -\Sigma(mn) \end{matrix}$$

$$\Sigma(l) \quad \Sigma(m) \quad -\Sigma(n)$$

NOTE: most current computer spreadsheet programs have a function that extracts the determinant from a square matrix of values. For example, Quattro for Windows has a @MDET(range) function where “range” would represent the cell range of the diagonal cells of the matrix.

$$D = \Sigma(l^2)\Sigma(m^2)(N) + \Sigma(lm)\Sigma(m)\Sigma(l) + \Sigma(l)\Sigma(lm)\Sigma(m) \\ - \Sigma(l)\Sigma(m^2)\Sigma(l) - \Sigma(lm)\Sigma(lm)(N) - \Sigma(l^2)\Sigma(m)\Sigma(m)$$

$$D_A = -\Sigma(ln)\Sigma(m^2)(N) + \Sigma(lm)\Sigma(m)(-\Sigma(n)) + \Sigma(l)(-\Sigma(mn))\Sigma(m) \\ - \Sigma(l)\Sigma(m^2)(-\Sigma(n)) - \Sigma(lm)(-\Sigma(mn))(N) - (-\Sigma(ln))\Sigma(m)\Sigma(m)$$

$$D_B = \Sigma(l^2)(-\Sigma(mn))(N) + (-\Sigma(ln))\Sigma(m)\Sigma(l) + \Sigma(l)\Sigma(lm)(-\Sigma(n)) \\ - \Sigma(l)(-\Sigma(mn))\Sigma(l) - (-\Sigma(ln))\Sigma(lm)(N) - \Sigma(l^2)\Sigma(m)(-\Sigma(n))$$

$$D_C = \Sigma(l^2)\Sigma(m^2)(-\Sigma(n)) + \Sigma(lm)(-\Sigma(mn))\Sigma(l) + (-\Sigma(ln))\Sigma(lm)\Sigma(m) \\ - (-\Sigma(ln))\Sigma(m^2)\Sigma(l) - \Sigma(lm)\Sigma(lm)(-\Sigma(n)) - \Sigma(l^2)(-\Sigma(mn))\Sigma(m)$$

where (l, m, n) have the same symbolic meaning as in the previous discussion. (N) refers to the number of data. From the determinants the following coefficients may be calculated:

$$A = \frac{D_A}{D} \quad B = \frac{D_B}{D} \quad C = \frac{D_C}{D}$$

and from these coefficients the directional cosines are calculated:

$$\text{Cos}(\alpha_c) = \frac{A}{\sqrt{1 + A^2 + B^2}}$$

$$\text{Cos}(\beta_c) = \frac{B}{\sqrt{1 + A^2 + B^2}}$$

$$\text{Cos}(\gamma_c) = \frac{1}{\sqrt{1 + A^2 + B^2}}$$

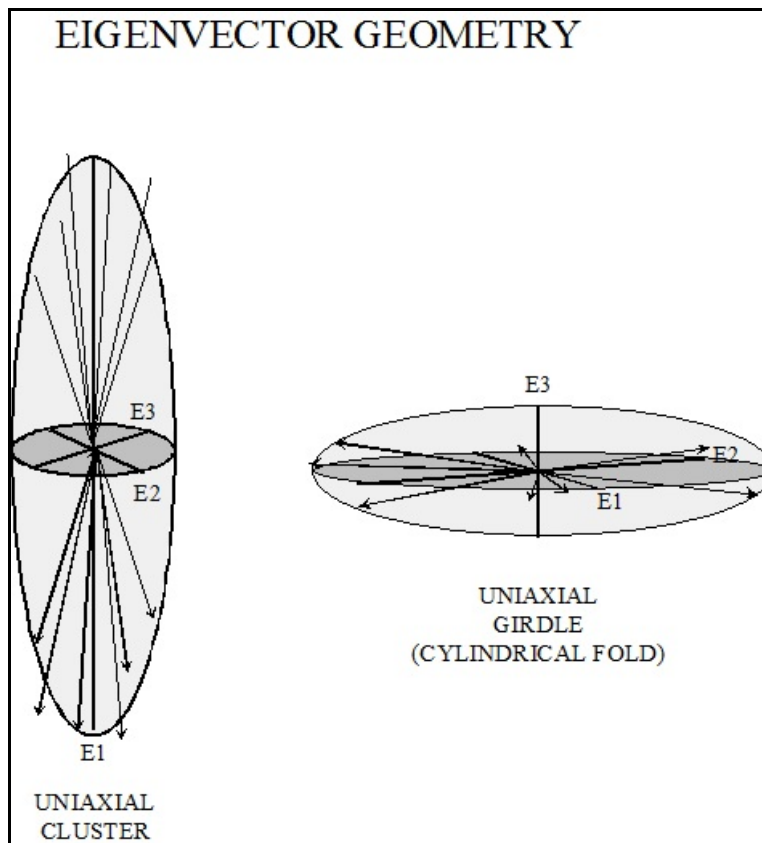
$$\text{Cos}(K_c) = \frac{-C}{\sqrt{1 + A^2 + B^2}}$$

where  $[\alpha_c, \beta_c, \gamma_c]$  represent the directional angles of the conical axis, and  $K_c$  is the  $\frac{1}{2}$  apical angle of the least-squares conical surface.

## V. Eigen Vectors

a) Eigenvectors are mathematically calculated using matrix algebra in a way that is different than the Ramsay (1968) procedures described before. The eigenvectors are mutually perpendicular in three dimensions, and are related to the mean attitude of the structure data set.

B) The eigenvectors are also the three axes of an ellipsoid. This ellipsoid should be imagined as the best-fit surface to the data set if each data is a vector of unit length (either linear structure elements or poles to planes), and the surface best-fits the end points of the vector. The midpoint of each unit vector would be at the center of the stereographic projection



**Figure 10-1** : Examples of eigenvector axial lengths.

sphere. In this regard, the eigenvector method makes no distinction between the upper and lower hemisphere as does the Ramsay method. Thus, the three eigenvectors are the three axes of the best-fit ellipsoid. Vector clusters produce a prolate ellipsoid, while cylindrical fold distributions yield oblate ellipsoids.

C) The Ramsay method suffers from the “double-plunge” effect because of the lower-hemisphere projection. For example, if an equal number of low-plunge lineations are doubly plunging north and south, the calculated average vector using the Ramsay method yields a vertical mean vector! The eigenvector method instead yields the correct horizontal north-south oriented vector.

D) To calculate the eigenvectors, the structure data must be converted into directional cosines, with which the below summations can be made:

$$\begin{aligned} \cos(\alpha) &= l \\ \cos(\beta) &= m \\ \cos(\gamma) &= n \end{aligned}$$

	l	m	n	“check”	lm	ln	mn	l <sup>2</sup>	m <sup>2</sup>	n <sup>2</sup>
Data #1										
Data #2										
.										
.										
.										
Data #N										

Summations:

When the summations are accumulated, the values can be processed by an eigenvector procedure to derive the magnitude and attitude of the three eigenvectors. Note that while the eigenvector 3x3 matrix contains 9 summation elements, some are equivalent, therefore, only 6 summations are actually required:

$$A = \begin{matrix} \sum l^2 & \sum lm & \sum ln \\ \sum ml & \sum m^2 & \sum mn \\ \sum nl & \sum nm & \sum n^2 \end{matrix}$$

Where “A” is the eigenvector solution. The results are best categorized graphically by **Figure 10-1** (Woodcock, 1977). The results from this graph fall in to one of three categories:

1. Uniaxial Cluster: this distribution indicates that data varies only slightly in attitude. A typical example would be mineral lineations in a metamorphic rock that have not been folded by later deformation. The dominant magnitude eigenvector is the mean

attitude of this distribution

2. Uniaxial Girdle: this distribution is typically the result of cylindrical folding of an original planar structure. When poles to this planar structure are plotted, a girdle distribution falls about the great circle that is perpendicular to the hinge of the fold. In this case the two dominant eigenvectors will fall on the girdle great circle. The hinge is the vector perpendicular to this great circle, and this of course will be the attitude of the small eigenvector. This eigenvector is the best-fit hinge attitude.
3. A third possibility is that the three eigenvectors have different values but are different magnitudes. This equivocal situation may be caused by uniformly random data, or conical folding. If conical folding is suspected, the Ramsay method should be used to evaluate the structure.

## V. Goodness of Fit Measures

a) In addition to calculating the least-squares geometry, one must also quantify the "goodness of fit" and whether or not the data is normally distributed about the least-square geometry.

b) If the data are normally distributed about the least-square geometry a standard deviation calculation can be used to quantify a confidence region about the least-squares fit. For example, if data from a point cluster can be demonstrated to be normally distributed about the least-squares vector then a conical confidence with an apical angle of four standard deviations ( $\pm 2$  standard deviations) should include approximately 95% of present and future measurements. The equation for the standard deviation is listed below:

$$S = \sqrt{\frac{\sum_{i=1}^n (\theta_i - \theta_{ideal})^2}{n - 1}}$$

where  $\theta_i$  is the actual angular arc between the axis of the geometry and the  $i$ th data vector, and  $\theta_{ideal}$  is the angular arc between the surface of the least-squares geometry and the axis of the least-squares geometry, measured in the same plane as  $\theta_i$ . The variable "n" is the number of data elements. For a vector, cylindrical, and conical fit  $\theta_{ideal}$  is equal to 0, 90, and the cone apical angle degrees respectively. To calculate the angle theta between any two vectors the following relationship may be used:

$$\cos(\theta_{ij}) = (\cos(\alpha_i))(\cos(\alpha_j)) + (\cos(\beta_i))(\cos(\beta_j)) + (\cos(\gamma_i))(\cos(\gamma_j))$$

where  $\theta_{ij}$  is the angle between the two vectors  $i$  and  $j$  that have directional angles  $(\alpha_i, \beta_i, \gamma_i)$  and  $(\alpha_j, \beta_j, \gamma_j)$ .

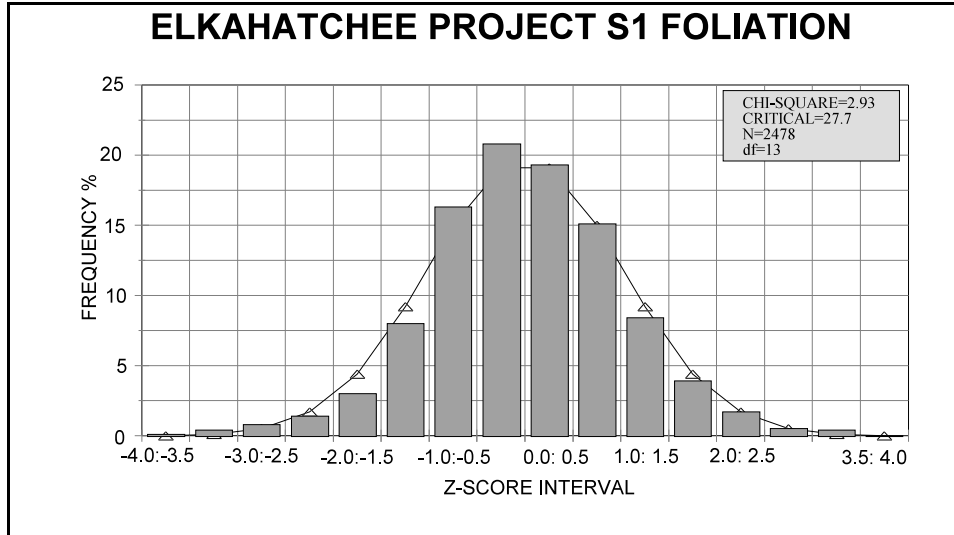
c)  $R^2$  (*Coefficient of Determination*) can be calculated to measure the degree to which the covariance of the data is explained by the least-squares geometry. The value of  $R^2$  ranges from 0.0 (no relationship) to 1.0 (perfect relationship). An  $R^2$  value of 1.0 could only be attained if every data vector falls perfectly on the least-squares surface. A purely random data set would produce an  $R^2$  value of 0 for a least-squares plane or cone. It is not possible to calculate  $R^2$  for a least-squares vector because there is no surface fit to the data. The equation for the calculation of  $R^2$  is listed below:

$$R^2 = \frac{\sum_{i=1}^n (\theta_E)_i^2}{\sum_{i=1}^n (\theta_O)_i^2}$$

where  $\theta_E$  (“expected”) represents the angle between the geometric mean vector of the data set (equivalent to a least-squares vector fit) and the fit surface (cylindrical or conical) measured in the plane that contains the mean vector and axis of the least-squares surface. The  $\theta_O$  (“observed”) angle is the arc between the geometric mean and the “*ith*” data vector measured in the plane common to both. Note that if the least-squares conical or cylindrical surface passes perfectly through each data vector the value of  $(\theta_E)^2$  and  $(\theta_O)^2$  are equivalent, therefore,  $R^2$  would equal unity. As the deviations of data vectors from the fit surface become larger, the denominator of the equation becomes larger, causing  $R^2$  to become lower in value. The  $\theta_E$  angle is equivalent to 90 degrees if the fit surface is cylindrical, the  $\frac{1}{2}$  apical angle if the fit surface is conical.  $R^2$  cannot be calculated for a vector fit.

d) A test for normal distribution can be accomplished with the  $\chi^2$  statistic. A full discussion of this method is beyond the scope of this text (see Davis, 1992), however, the below equation is given as for reference:

$$\chi^2 = \sum_{i=1}^n \left( \frac{[(\theta_O)_i - (\theta_E)_i]^2}{(\theta_E)_i} \right)$$



**Figure 10-2** : Example of data set that is normally distributed about a least-squares cylindrical surface according to the chi-square statistic.

$\theta_O$  and  $\theta_E$  are defined as described above. As can be verified from the above equation, as the data deviate from a normal distribution the  $\chi^2$  statistic grows larger in magnitude. Standard statistics texts contain tables for this statistic that requires the *degrees of freedom* (df) and the desired confidence level. Since data must be converted to *z scores* before plotted as a frequency distribution, the df is the number of categories (bars) on the frequency histogram minus the number of calculated values necessary for the z scores (mean + standard deviation = 2). If the  $\chi^2$  statistic is larger than the critical value given in tables, the data fail the test and cannot be considered a normal distribution. The **Figure 10-2** example above is an example of a data set that is normally distributed about a least-squares geometry according to the  $\chi^2$  statistic of 2.33 (critical value = 27.7, same as used by the stereonet analysis program NETPROG).

## EXERCISE 10A: Stereograms and Statistical Techniques

Refer to your class notes relating to statistical analysis of orientation data.

In this lab you will apply statistical techniques discussed in class to actual orientation data. In the below exercise you will use NETPROG to calculate best-fit statistics on 3 separate problems demonstrating vector, cylindrical and conical data distributions. A measure of the “goodness-of-fit” will be calculated and plotted, and a  $\chi^2$  statistic will be used to evaluate whether the data distribution is “normal” or “non-normal”.

**Problem 1.** Below is a set of measured orientations of a linear platinum-bearing zone collected by a mining company. The company wants to sink a mine shaft along the zone and therefore needs an average orientation determined from the data. You are a geologist employed by a consulting firm and your supervisor has assigned to you the task of analyzing the data for the mining company. The head of the mining company - a person well versed in statistics, but not in structural geology - informs you that contouring the data and "eyeballing" an average orientation is not good enough; he wants a statistical determination of the average orientation of the data, a statistical measure of the goodness of fit, and a measure of whether or not the data is normally distributed. Determine the best-fit (mean) vector to this data set using the eigen vector method, and determine the standard deviation about the best-fit vector in degrees. Plot the data as points on a stereonet, and plot the position of the best-fit vector. Assuming that the data is normally distributed about the mean vector, plot on the stereonet a "cone of confidence" that should contain over 90% of the data (i.e. 2 standard deviations) if the data is normally distributed.

Table 1- Mineralized zone linear attitudes for Problem 1.			
S 40 W 39	S 38 W 25	S 36 W 21	S 23 W 30
S 42 W 41	S 36 W 29	S 33 W 26	S 17 W 35
S 36 W 47	S 34 W 35	S 32 W 29	S 15 W 34
S 29 W 50	S 28 W 38	S 26 W 30	S 26 W 22
S 44 W 29	S 25 W 40	S 24 W 34	S 25 W 25
S 36 W 33	S 21 W 43	S 19 W 38	
S 34 W 41	S 15 W 44	S 36 W 15	
S 28 W 43	S 28 W 36	S 32 W 20	
S 17 W 50	S 23 W 38	S 30 W 25	
S 33 W 38	S 14 W 40	S 26 W 28	

Make sure the following appear on the stereonet for Problem 1:

Data and Eigen vectors plotted correctly (13 points)

Orientation of best-fit vector (plotted as a dot plus cross and list the plunge and bearing) (10 points):

2-S.D. cone of confidence plotted and listed,  $\chi^2$  listed (plotted as a conical surface on stereonet) (10 points)

Problem 2. Below are strike and dip measurements of bedding taken from a cylindrical fold system. Determine statistically the orientation of the hinge using the Eigen vector method. Determine the standard deviation of the fit relative to the data. Plot the data as poles to bedding, and plot the best-fit hinge on the stereogram. Plot the great circle at  $90^\circ$  to the best-fit hinge. Also plot the pair of conical surfaces that lie at two standard deviations on either side of the least-squares cylindrical girdle— this describes the 95% confidence belt.

Table 2- Bedding attitudes for Problem 2.			
N 73 W 64 W	N 45 W 90 E	N 56 W 77 W	N 00 E 50 E
N 21 W 68 E	N 03 E 42 E	N 55 W 74 W	N 15 W 54 E
N 75 W 53 W	N 06 W 56 E	N 54 W 82 W	N 25 W 61 E
N 76 E 43 E	N 17 W 57 E	N 81 W 51 W	N 88 W 51 W
N 83 E 52 E	N 28 W 66 E	N 10 W 50 E	N 69 W 64 W
N 88 E 46 E	N 25 W 72 E	N 16 W 68 E	
N 73 E 49 E	N 81 W 60 W	N 43 W 80 E	
N 70 W 66 W	N 71 W 59 W	N 38 W 76 E	
N 15 W 62 E	N 64 W 65 W	N 33 W 80 E	
N 85 W 58 W	N 66 W 70 W	N 30 W 73 E	

Make sure the following appear on the stereonet for Problem 2:

Data and Eigen vectors plotted correctly (13 points)

Orientation of best-fit cylindrical hinge and girdle great circle (hinge plotted as a dot with a cross and list the plunge and bearing) (10 points):

2-S.D. cone of confidence plotted and listed,  $\chi^2$  and  $R^2$  listed (plotted as a conical surface on stereonet) (10 points)

Problem 3. Below are foliation measurements from the eastern Blue Ridge of Alabama. The data come from a terrane that has experienced more than one folding event, therefore, the folding of foliation is conical in nature rather than cylindrical. Plot the data as poles to foliation on the stereonet, and calculate the best-fit conical axis. Determine the standard deviation of the conical surface. Plot and label the conical surface and cone axis on the stereonet. Plot the pair of conical

surfaces that lie at  $\pm$  two standard deviations relative to the least-squares conical surface.

Table 3- Foliation attitudes for Problem 3.			
N 38 W 40 W	N 08 E 68 W	N 19 W 62 W	N 06 W 64 W
N 34 W 51 W	N 10 W 78 W	N 01 E 76 W	N 02 W 74 W
N 24 W 53 W	N 54 W 34 W	N 16 W 57 W	N 12 W 68 W
N 12 W 60 W	N 06 E 80 W	N 27 W 56 W	N 19 W 65 W
N 08 W 70 W	N 26 W 64 W	N 29 W 45 W	N 40 W 50 W
N 09 E 75 W	N 07 W 56 W	N 47 W 44 W	
N 17 E 72 W	N 22 E 24 E	N 44 W 37 W	
N 30 E 85 W	N 65 E 18 E	N 31 W 49 W	
N 41 E 80 W	N 88 W 30 W	N 58 W 40 W	
N 14 E 80 W	N 58 W 30 W	N 43 W 32 W	

Make sure the following appear on the stereonet for Problem 3:

Data and Eigen vectors plotted correctly (13 points)

Orientation of best-fit conical hinge and conical small circle (hinge plotted as a dot with a cross and list the plunge and bearing and conical angle) (10 points):

2-S.D. cone of confidence plotted and listed,  $\chi^2$  and  $R^2$  listed (plotted as 2 conical surfaces on stereonet) (10 points)

## EXERCISE 10B: Stereograms and Statistical Techniques

In this lab you will apply statistical techniques discussed in class to actual orientation data. In the below exercise you will use NETPROG to calculate best-fit statistics on 3 separate problems demonstrating vector, cylindrical and conical data distributions. A measure of the “goodness-of-fit” will be calculated and plotted, and a  $\chi^2$  statistic will be used to evaluate whether the data distribution is “normal” or “non-normal”.

**Problem 1.** Below is a set of measured orientations of a linear platinum-bearing zone collected by a mining company. The company wants to sink a mine shaft along the zone and therefore needs an average orientation determined from the data. You are a geologist employed by a consulting firm and your supervisor has assigned to you the task of analyzing the data for the mining company. The head of the mining company - a person well versed in statistics, but not in structural geology - informs you that contouring the data and "eyeballing" an average orientation is not good enough; he wants a statistical determination of the average orientation of the data, and a statistical measure of the goodness of fit. Determine the best-fit (mean) vector to this data set using the eigen vector method, and determine the standard deviation about the best-fit vector in degrees. Plot the data as points on a stereonet, and plot the position of the best-fit vector. Assuming that the data is normally distributed about the mean vector, plot on the stereonet a "cone of confidence" that should contain over 90% of the data (i.e. 2 standard deviations).

Table 1- Mineralized zone linear attitudes for Problem 1.			
N 51 E 45	N 59 E 42	N 66 E 35	N 57 E 43
N 48 E 42	N 60 E 36	N 64 E 25	N 62 E 33
N 47 E 35	N 59 E 36	N 84 E 53	N 64 E 27
N 48 E 25	N 58 E 29	N 79 E 48	N 73 E 40
N 58 E 52	N 59 E 24	N 71 E 40	N 71 E 43
N 60 E 44	N 62 E 35	N 68 E 30	
N 53 E 41	N 75 E 51	N 70 E 28	
N 55 E 33	N 70 E 46	N 79 E 38	
N 68 E 50	N 67 E 48	N 76 E 40	
N 65 E 45	N 69 E 38	N 53 E 23	

Make sure the following appear on the stereonet for Problem 1:

Data and Eigen vectors plotted correctly (13 points)

Orientation of best-fit vector (plotted as a dot plus cross and list the plunge and bearing) (10 points):

2-S.D. cone of confidence plotted and listed,  $\chi^2$  listed (plotted as a conical surface on stereonet) (10 points)

Problem 2. Below are strike and dip measurements of bedding taken from a cylindrical fold system. Determine statistically the orientation of the hinge using the Eigen vector method. Determine the standard deviation of the fit relative to the data. Plot the data as poles to bedding, and plot the best-fit hinge on the stereogram. Plot the great circle at 90° to the least-squares hinge. Also plot the pair of conical surfaces that lie at two standard deviations on either side of the least-squares cylindrical girdle– this describes the 95% confidence belt.

Table 2- Bedding attitudes for Problem 2.			
N 44 W 80 E	N 13 W 71 W	N 20 W 77 W	N 48 E 43 W
N 17 E 54 W	N 57 E 37 W	N 24 W 86 W	N 30 E 42 W
N 42 W 72 E	N 32 E 44 W	N 23 W 78 W	N 18 E 49 W
N 64 W 59 E	N 26 E 44 W	N 47 W 70 E	N 53 W 69 E
N 65 W 66 E	N 10 E 50 W	N 42 E 44 W	N 38 W 83 E
N 55 W 64 E	N 11 E 57 W	N 23 E 55 W	
N 68 W 64 E	N 54 W 83 E	N 09 W 61 W	
N 39 W 85 E	N 39 W 78 E	N 03 W 58 W	
N 29 E 55 W	N 33 W 84 E	N 02 W 59 W	
N 51 W 76 E	N 35 W 89 E	N 06 E 56 W	

Make sure the following appear on the stereonet for Problem 2:

Data and Eigen vectors plotted correctly (13 points)

Orientation of best-fit cylindrical hinge and girdle great circle (hinge plotted as a dot with a cross and list the plunge and bearing) (10 points):

2-S.D. cone of confidence plotted and listed,  $\chi^2$  and  $R^2$  listed (plotted as a conical surface on stereonet) (10 points)

Problem 3. Below are foliation measurements from the eastern Blue Ridge of Alabama. The data come from a terrane that has experienced more than one folding event, therefore, the folding of foliation is conical in nature rather than cylindrical. Plot the data as poles to foliation on the stereonet, and calculate the best-fit conical axis using Ramsay’s method. Determine the standard deviation of the conical surface. Plot and label the conical surface and cone axis on the stereonet. Plot the pair of conical surfaces that lie at ± two standard deviations relative to the least-squares conical surface.

Table 3- Foliation attitudes for Problem 3.			
N 24 W 23 E	N 64 E 39 W	N 70 W 29 E	N 85 E 34 W
N 42 W 27 E	N 89 W 40 E	N 76 E 46 W	N 79 E 44 W

Table 3- Foliation attitudes for Problem 3.			
N 60 W 25 E	N 03 E 20 E	N 77 W 27 E	N 89 W 42 E
N 84 W 30 E	N 70 E 51 W	N 58 W 35 E	N 74 W 36 E
N 83 E 35 W	N 64 W 36 E	N 47 W 24 E	N 33 W 28 E
N 65 E 46 W	N 86 E 26 W	N 16 W 27 E	
N 54 E 45 W	N 76 E 50 E	N 06 W 21 E	
N 44 E 62 W	N 59 E 38 E	N 45 W 20 E	
N 34 E 66 W	N 33 E 31 E	N 00 W 25 E	
N 60 E 52 W	N 18 E 24 E	N 05 E 18 E	

Make sure the following appear on the stereonet for Problem 3:

Data and Eigen vectors plotted correctly (13 points)

Orientation of best-fit conical hinge and conical small circle (hinge plotted as a dot with a cross and list the plunge and bearing and conical angle) (10 points):

2-S.D. cone of confidence plotted and listed,  $\chi^2$  and  $R^2$  listed (plotted as 2 conical surfaces on stereonet) (10 points)

## LABORATORY 11: Stress Analysis

### I. Stress Field Ellipsoid

A) Any state of stress can be fully represented by the *stress ellipsoid*. The stress ellipsoid is a triaxial ellipsoid that is defined by three axes of different length:

1.  $\sigma_1$ : maximum *normal stress* axis.
2.  $\sigma_2$ : intermediate normal stress axis.
3.  $\sigma_3$ : minimum normal stress axis.

For conditions of *lithostatic stress*, the above stress axes are equal in magnitude and therefore no plane that passes through a body subjected to a lithostatic stress will have a shear stress.

B) Note that all three axes are mutually perpendicular. Also there are unique directions of normal stress for  $\sigma_1$  and  $\sigma_3$  (maximum and minimum normal stress) but there are an infinite number of normal stress directions equal to  $\sigma_2$  that are arrayed in the two *circular sections* of the stress ellipsoid. The total condition of stress affecting a rock mass can be described as the *stress tensor*, which is a second-order tensor. An single instance of a force acting on an area can be described as a stress traction. Both the stress field tensor and stress tractions are second-order tensors, which means that they cannot be resolved as simple vector quantities.

C) A plane that passes through a body under a stress field that is also perpendicular to one of the principal normal stress directions will have no *shear stress* ( $\tau$ ) on it. Any other plane will have some value of shear stress upon it.

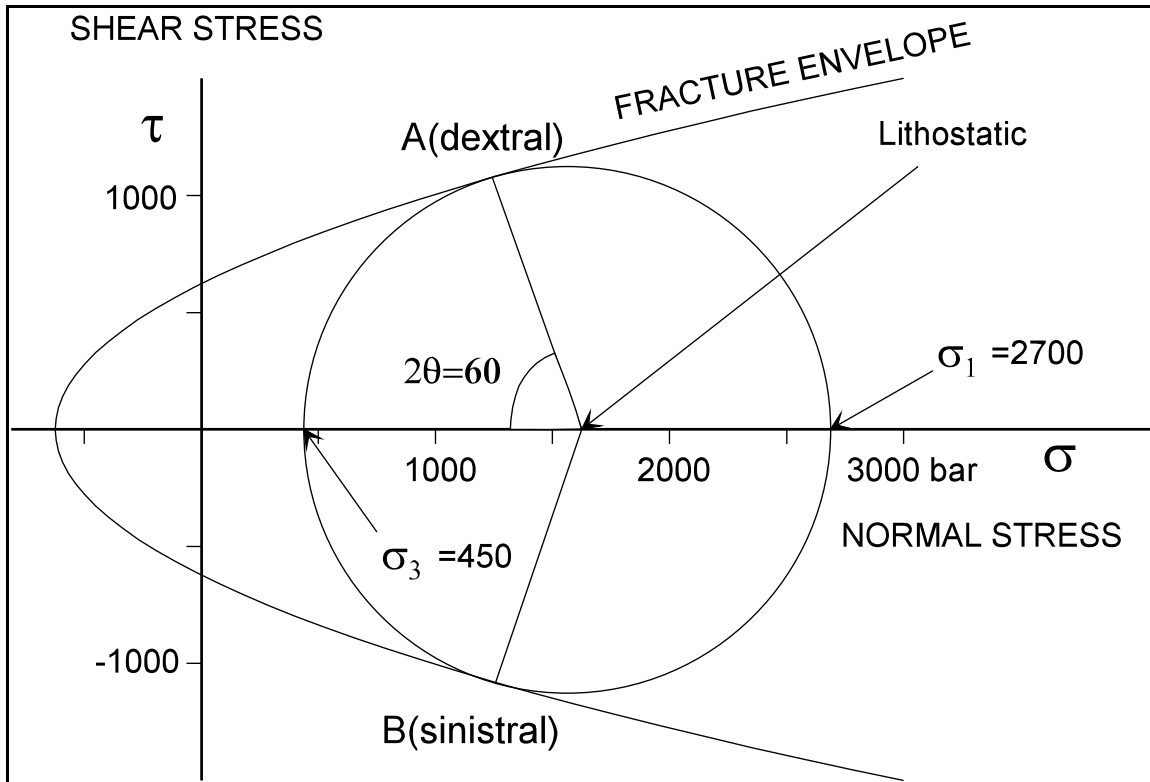
D) The stress ellipsoid is extremely useful in predicting fault and joint formation in real rocks under a stress field. A graph termed the *Mohr Circle Diagram* has been developed to determine the magnitude of normal stress and *shear stress* on any plane that passes through the rock mass subjected to a *stress tensor*. The orientation of the principal axes of the stress ellipsoid and the fracture planes can be tracked on the stereonet.

E) The development of a fracture plane to form a fault or joint will occur in a rock mass when the ratio of  $\tau/\sigma$  reaches a critical value. The locus of these critical values is termed the *Mohr fracture envelope* that can be empirically determined for any rock by experimental means.

### II. Mohr Circle Diagram

A) The Mohr circle is a circle plotted on a (X, Y) graph defined by normal stress values ( $\sigma$ ) along the x axis and shear stress ( $\tau$ ) along the y axis. The diameter of the Mohr circle is defined by the position of  $\sigma_1$  and  $\sigma_3$  on the x axis. Note that  $\sigma_2$  is essentially ignored on this diagram since fractures are parallel to the intermediate axis.

B) The below diagram is an example of a Mohr circle graph with the fracture envelope plotted. The two fracture planes labeled A and B are termed the *conjugate fractures* because, if the rock is mechanically homogenous, the two fractures will form simultaneously and symmetrically about the maximum normal stress direction.



**Figure 11-1** : Example of the Mohr stress circle with fracture envelop.

C) The perimeter of the circle represents all of the possible stress states on planes passing through the center of the stress field. The center of the circle is fixed by the *lithostatic stress* value which is dependent on the burial depth. The angle along the perimeter of the circle from  $\sigma_3$  to the point of interest is termed the  $2\theta$  angle. For fracture (A),  $2\theta$  is  $+60^\circ$ , whereas for fracture plane (B),  $2\theta$  is  $-60^\circ$ .

D) The conjugate fracture planes (A) and (B) have equivalent  $\sigma$  and  $\tau$  magnitudes, however, (A) has dextral (+) sense of shear, while (B) has sinistral (-) sense of shear. Also note that on the Mohr Circle diagram in **Figure 11-1** that the  $2\theta$  angle is measured clockwise from  $\sigma_3$  for positive values of  $\tau$ .

E) The below **Figure 11-1** diagram displays the relationship of the principle stresses and shear planes with respect to an actual physical specimen that is deformed under laboratory conditions. Note that the shear plane has a dextral sense of shear and therefore a positive value of  $\tau$ . This means that if the angle measured from the shear plane to  $\sigma_1$  is clockwise, then  $\tau$  is positive and the sense of shear must

be dextral. Likewise, an anticlockwise angle measured from the fracture plane to  $\sigma_1$  defines a negative  $\tau$  shear plane. Remember that this rule is used when viewing the actual physical sample. Also noteworthy is the fact that within the physical specimen if two conjugate shear planes form, that  $\sigma_1$  will bisect the acute angle and  $\sigma_3$  the obtuse angle.

### III. Constructing the Mohr Circle Graph

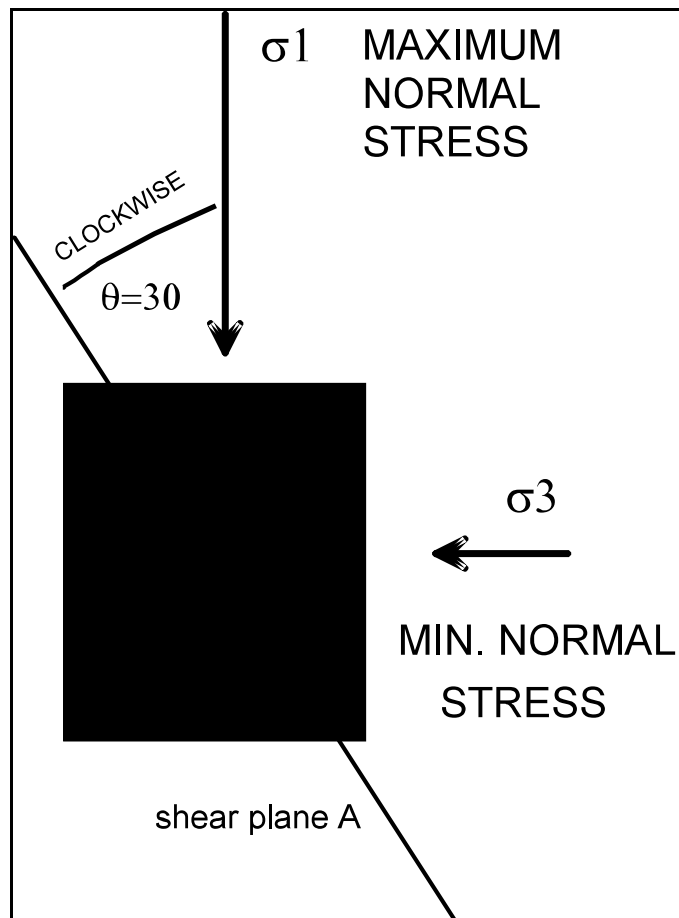
A) The construction of the Mohr Circle graph assumes that  $\sigma$  is plotted on the X axis, and  $\tau$  on the Y axis. This is normally done on standard 10sqi graph paper, or alternatively with the charting capabilities of a spreadsheet application. If the graph is plotted manually, care should be taken selecting the range of the X and Y axes to ensure that the Mohr Circle will fit on the sheet of paper. It is usually necessary to place the Y axis at sigma values greater than 0 because sigma may be large compared to tau. The scale of both axes should be equivalent (i.e. one inch = 200 bar).

B) If the maximum and minimum values of  $\sigma$  are known, the Mohr circle can be plotted by constructing a circle that passes through those points on the x axis, and which has a center halfway between the two points. Mathematically the center of the circle is  $(\sigma_1 + \sigma_3)/2$ .

C) If the stress state of two planes that pass through the stress field are known ( $\sigma$  and  $\tau$ ), these two points must fall on the perimeter of the Mohr circle. The perpendicular bisector of the chord between these two points will cross the x axis at the center of the circle.

### IV. Determining the Attitude of Stress Axes and Fracture Planes

A) In addition to the magnitude of the principal stress axes, the geologist must also relate the orientation of the stress ellipsoid to a "real-world" coordinate system. The most convenient device for accomplishing this is the stereonet with geographic north indexed in the standard way.



**Figure 11-2** : Actual physical test specimen for Mohr circle example.

B) The following rules should serve as guidelines for plotting stress field elements:

1. Remember that the three principal stress ellipsoid axes are mutually perpendicular, therefore, if the attitude of any two of the axes are determined the other third must be located  $90^\circ$  to the plane that contains the other two.
2. Conjugate shear planes always intersect at the intermediate normal stress axis  $\sigma_2$  axis.
3. The maximum principle stress,  $\sigma_1$ , bisects the acute angle formed by the conjugate shear planes (see **Figure 11-2**). Likewise, the minimum principle stress  $\sigma_3$  must bisect the obtuse angle formed by the conjugate shear planes.
4. If the  $2\theta$  is measured from the Mohr circle plot, remember that in reality,  $\theta$  is the angle that the fracture plane makes with  $\sigma_1$ . A common mistake is to use  $\theta$  as if it were the angle that the fracture plane makes with the minimum normal stress direction ( $\sigma_3$ ) because that is the reference from which  $2\theta$  is measured on the Mohr stress circle.
5. To determine the sense of shear on a fracture plane plotted on the stereonet it may be necessary to rotate the entire diagram until the  $\sigma_1$ - $\sigma_3$  is horizontal.

C) Remember that the Mohr circle graph can determine magnitudes of stress for any plane passing through the stress field, and it can determine a  $2\theta$  value. It cannot, however, yield any information about the orientation of the stress ellipsoid axes or the fracture planes.

D) The stereonet can solve for the attitude of the stress ellipsoid axes and shear planes, however, it cannot yield any information on the magnitude of the stresses.

#### V. Mathematical Basis for Mohr Circle

A) The Mohr circle can easily be expressed as a function of the maximum and minimum normal stress values. With the below equations the stress state of any plane passing through the stress field can be calculated:

$$\sigma = \frac{\sigma_1 + \sigma_3}{2} - \frac{\sigma_1 - \sigma_3}{2} \cos(2\theta)$$

$$\tau = \frac{\sigma_1 - \sigma_3}{2} \sin(2\theta)$$

where  $\sigma$  and  $\tau$  represent the normal and shear stress respectively acting on the plane of interest subject to a stress tensor of magnitudes  $\sigma_1$  and  $\sigma_3$ . The angle  $\theta$  is the angle that the plane of interest makes with  $\sigma_1$  measured clockwise from the plane to  $\sigma_1$ . Furthermore,  $\theta$  must be less than  $90^\circ$  in absolute magnitude, therefore, if the angle less than  $90^\circ$  is measured counterclockwise from the plane to the  $\sigma_1$  direction, then  $\theta$  is negative.

EXERCISE 11A: Mohr Circle and Stress Calculations

Problem 1. Given the following orientations for the principal stress axes:

$$\begin{aligned} \sigma_1 &: 0^\circ, \text{N}90^\circ\text{E} \\ \sigma_3 &: 90^\circ, \text{N}0^\circ\text{E} \end{aligned}$$

find the orientation of  $\sigma_2$ . If the  $\theta$  angle is  $20^\circ$  for conjugate fractures, plot both shear planes on the stereonet along with the principal normal stress directions ( $\sigma_1$ ,  $\sigma_2$ , and  $\sigma_3$ ) labeled. As observed from the south looking to the north, label the conjugate shear planes in terms of the sense of shear movement- sinistral or dextral. If the conjugate shears are considered to be faults, how would you classify each fault? Determine and report the attitude of each shear plane.

Problem 2. Assume that:

$$\begin{aligned} \sigma_1 &= 2050 \text{ bars} & 50^\circ, \text{N}40^\circ\text{E} \\ \sigma_3 &= 1600 \text{ bars} & 24^\circ, \text{S}18^\circ\text{E} \end{aligned}$$

Scale: 1"=200 bars

What is the maximum value of  $\tau$  (shear stress) along any plane that passes through a body under the above stress state (determine graphically)? What is the orientation of  $\sigma_2$  (determine on the stereonet)? What are the orientations of the body planes that have maximum  $\pm \tau$  values (determine on the stereonet)? Report the sense of shear for each plane with your answer.

Problem 3. Given the following values of  $\sigma$  and  $\tau$  stress for two planes passing through a body under a stress field:

	$\sigma$	$\tau$	Orientation
1.	1800	100	N0°E, 50°W
2.	2100	200	N64°E, 30°NW

Find the values of  $\sigma_1$  and  $\sigma_3$  (graphically). On a stereonet plot the orientation of the two planes, along with the orientations of  $\sigma_1$ ,  $\sigma_2$ , and  $\sigma_3$ . Report the values of  $2\theta$  for each shear plane

Scale: 1"= 200 bars.

## EXERCISE 11B: Mohr Circle and Stress Calculations

## LABORATORY 12: Strain Analysis

### I. Strain Analysis

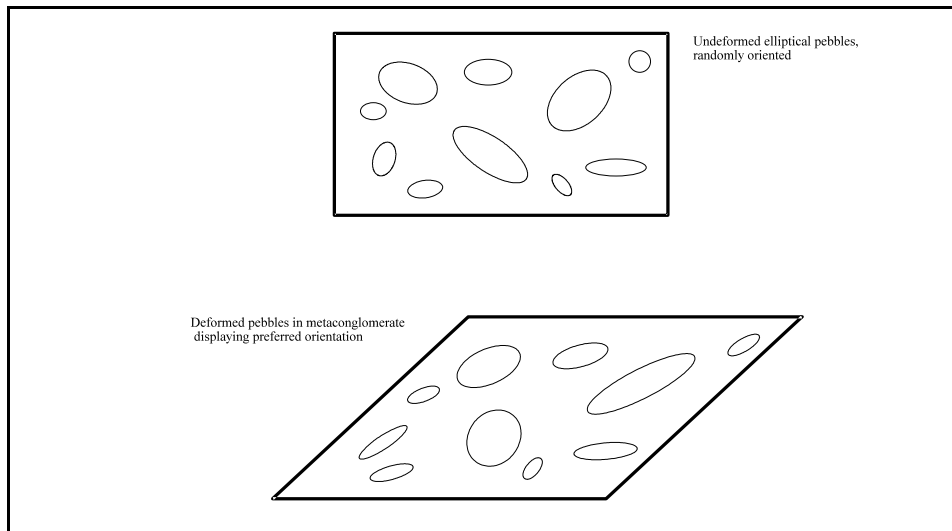
A) *Strain markers* must be present in rock before strain can be analyzed.

B) There must be little or no mechanical difference between strain marker and matrix, otherwise the strain analysis may be invalid.

Examples of low mechanical contrast

1. Oolites in limestone
2. Quartz pebbles in a quartzite (Metaconglomerate)

C) In practice most strain markers are not perfectly spherical in the undeformed state- if they were we could directly measure the dimensions of any individual ellipsoid to obtain the *finite strain ellipse* dimensions.



**Figure 12-1** : Simple shear of initially random ellipsoidal pebbles to form a preferred orientation of strain ellipsoids.

D) Field analysis of deformed rocks generally assumes *homogenous plane strain* (constant volume conditions) because it greatly simplifies calculations and is valid if the *dilation* component of strain is not significant.

E) We assume that strain markers began as randomly oriented ellipsoidal objects before deformation, such as pebbles in a stream bed. If strain is truly homogenous the original *ellipsoids* will still be ellipsoidal after deformation. The ellipsoids will display a dimensional preferred orientation after deformation. Note that non-random original orientations will still produce a preferred attitude after deformation, however, it may invalidate analysis of strain using the hyperbolic net, and the  $R_F/\Phi$  method described below.

F)  $\Phi$  is the measured angle that the X axis of an elliptical strain marker makes with some reference direction. Usually this direction is chosen to be a significant tectonite direction, such as the trace of  $S_1$  at the exposure. In addition to  $\Phi$ , the axial ratio (X/Z) is measured as the  $R_F$  value for each ellipse.

G) The *finite strain ellipse* should be imagined to be the ellipsoid body that result from the deformation of an original sphere with diameter equal to 1.0 length. This body is also imagined to have suffered all deformation affecting the rocks under consideration. Usually one of the goals of kinematic analysis is to find the dimensions and attitudes of the axes of the finite strain ellipse. The ratio of the X and Z axes of the finite strain ellipse (X/Z) is referred to as  $R_S$ . Likewise, the angle that the finite strain ellipse makes with the chosen reference direction is termed  $\Phi_S$ .

## II. Use of the Hyperbolic Net (De Paor's Method)

A) After  $R_F$  and  $\Phi$  values are tabulated for all strain marker ellipses, they are plotted on a special projection termed the *hyperbolic net*. The goal of this procedure is to determine the  $R_S$  and  $\Phi_S$  values for the total finite strain ellipse. The hyperbolic net uses the relationships demonstrated in **Figure 12-1** above to define the "best-fit" hyperbolic curve relative to the data.

B) Data is plotted on the hyperbolic net after the  $\Phi$  and  $R_F$  values are tabulated:

1. Rotate the overlay so that the  $\Phi$  angle position is at the due north point of the primitive. Positive angles are to the clockwise of the "R" reference tic, negative angles are counterclockwise.
2. From the center of the net move up along the vertical line until the hyperbolic curve that corresponds to the value of  $R_F$  is found. Mark a dot at this point. Note that the center of the net begins at a value of 1.
3. Continue with steps (1) and (2) above until all data is plotted.

C) After plotting the data on the net, follow these steps:

1. Sketch a smooth line around all of the data points. The polygon thus formed should be as “simple” as possible (i.e. lowest number of sides).

2. Find the north-south line on the overlay that divides the data distribution into equal area halves. This line defines the  $\Phi_s$  direction angle.

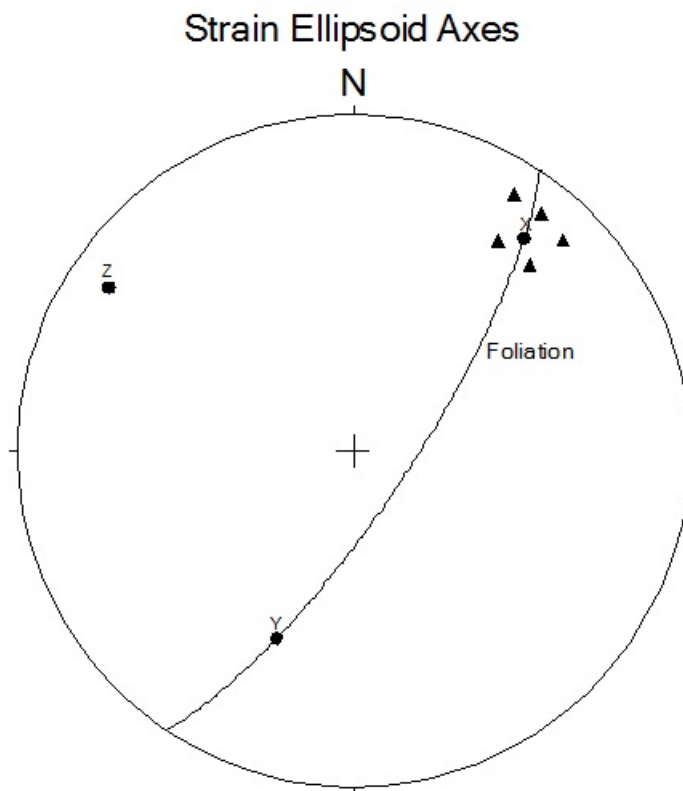
2. Find the “best-fit” hyperbolic curve that splits the data into 25% area quarters. This hyperbolic curve defines the value of the axial ratio (X/Z) for the finite strain ellipse. This value is  $R_s$ . After drawing this curve on the overlay, the four quadrants defined by the  $\Phi_s$  and  $R_s$  curves should divide the data into roughly 25% proportions.

D) Note that if the data deviate significantly from the 25% per quadrant rule the strain markers probably had a preferred attitude before deformations. This may invalidate the  $R_F/\Phi$  method.

E) If we assume plane strain, and, therefore, constant volume throughout deformation, we can calculate the actual dimensions of the finite strain ellipsoid assuming a convenient pre-deformation diameter, such as 1 unit length. This in turn allows the calculation of stretch (S) values in the principle directions. Once these values are determined, we can calculate, using the general Mohr circle strain equations, the values of  $\lambda$ ,  $\gamma$ ,  $\Psi$ , and  $\alpha$  for any direction defined as  $\theta_d$ .

### III. Plotting the Attitude of the Finite Strain Ellipse

A) The X, Y, and Z axes of the finite strain ellipsoid are mutually perpendicular, therefore, any one of these axes will be the pole to the plane defined by the other two axes. Since geologists usually purposely find the X-Z plane and measure the attitude of this plane at the exposure, usually the Y axis is assumed to be the pole to the XZ



**Figure 12-2** : Plot of strain axes and foliation.

plane.

B) Oriented sample must be taken and labeled in the field if one is to calculate the attitude of the finite strain axes. In the field this is done by physically drawing the strike and dip lines on the X-Z surface of the sample before it is disturbed. In this way the sample may be re-oriented in the laboratory.

C) It is often possible to relate the finite strain ellipse to tectonite fabric elements such as  $S_1$  foliation. Stretching lineations tend to develop parallel or sub-parallel to the X axis, and are oriented in the X-Y plane. The  $S_1$  foliation plane is often equivalent to the X-Y plane, therefore, plots of lineation data may fall systematically along the  $S_1$  great circle. Alternatively, plots of poles to  $S_1$  will plot in the vicinity of the minimum elongation (X) of the finite strain ellipse.

#### IV. Solving for the Dimensions of the Finite Strain Ellipse

A) If plane strain is assumed, we know that the starting reference sphere and the resulting finite ellipsoid will have the same volume.

B) Mathematical proof:

Given:

$V_i$  = volume of undeformed sphere with radius  $r$ .

$r = 1.0$

$V_f$  = volume of final ellipsoid that is the product of the homogenous deformation of the initial sphere of volume  $V_i$ . The (X, Y, Z) directions of the ellipsoid are parallel to the (a, b, c) directions in the below figure:

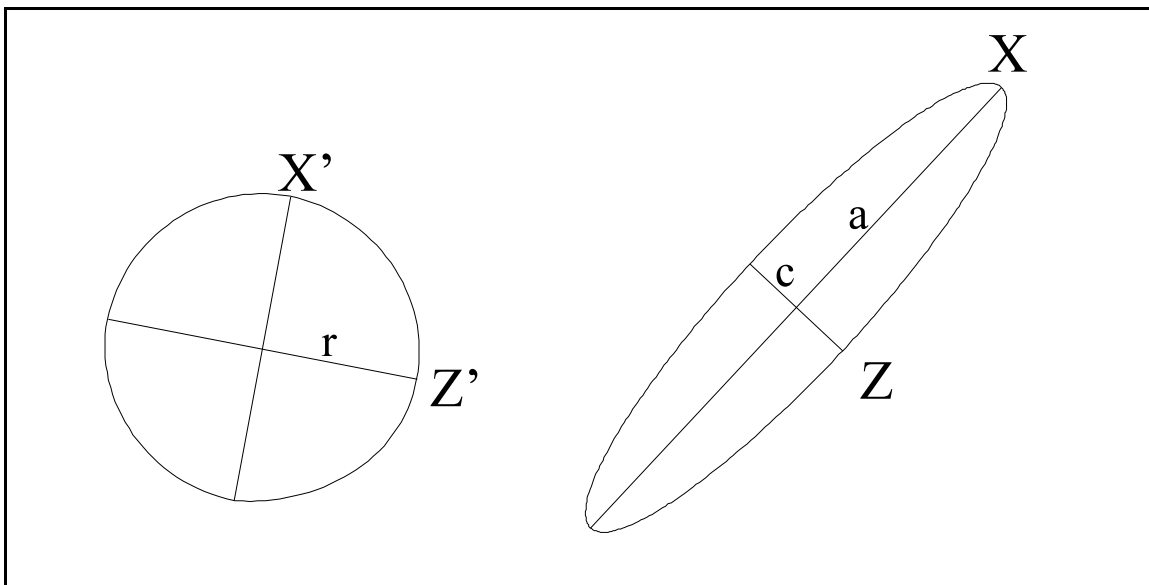
$R_s$  = ratio of X to Z for the finite strain ellipse.

Find: Dimensions of the total finite strain ellipsoid assuming that the original sphere is deformed by plane strain. Under these conditions the initial sphere and final ellipsoid should have equal volume:

$$V_i = V_f$$

$$V_i = (4/3)\pi r^3$$

$$V_f = (4/3)\pi abc$$



**Figure 12-3** : Undeformed and deformed strain marker reference used for derivation of formulae.

Setting both volume equations equal to one another we can simplify to:

$$r^3 = abc$$

Because the deformation is via plane strain, the length of  $b$  should equal the original length  $r$ :

$$r^2 = ac$$

In the original definition of the proof  $r = 1$ , therefore:

$$1 = ac$$

Now we can use the definition of  $R_s$  to solve simultaneous equations:

$$R_s = X/Z = 2a/2c = a/c$$

Substituting into the above equation:

$$a = R_s c$$

$$1.0 = (R_s)(c)(c)$$

$$1.0 = R_s c^2$$

$$c = \text{Sqrt}(1/R_s)$$

Therefore:

$$a = 1/c = \text{Sqrt}(R_s)$$

With these equations you can convert the  $R_s$  value measured from the hyperbolic net directly into the dimensions of the finite strain ellipse. From the dimensions the axial stretch values can be calculated:

$$S_x = a/r = a = \text{Sqrt}(R_s)$$

$$S_z = c/r = c = \text{Sqrt}(1/R_s)$$

## EXERCISE 12A: Strain Analysis

### Problem 1

In **Figure 12-4** is a photograph of deformed ooids in limestone. Assuming that the ooids have been affected by homogenous plane strain, conduct a strain analysis using the hyperbolic net (De Paor's method). Use the traced outlines of the ellipsoids in **Figure 12-5** to measure  $R_F$  and  $\Phi$ . Measure  $\Phi$  relative to the N32W reference line in **Figure 12-5**. Report your measurements with a table organized as follows:

No.	X(inches)	Z(inches)	$R_F$	$\Phi$
1	0.822	0.590	1.393	-4
2	0.665	0.481	1.383	6
.	.	.	.	.
.	.	.	.	.

After finding  $R_S$  and  $\Phi_S$ , your goal will be to find the dimensions of the strain ellipsoid (i.e. the total finite strain ellipsoid) that before deformation is assumed to have been perfect sphere with a diameter of 1.0. When the dimensions are known, calculate the S (stretch value) for the X and Z directions of the total finite strain ellipsoid. Remember that if you can assume homogenous plane strain, then you can also assume that each ooid maintains constant volume in three dimensions and area in two dimensions before and after deformation. Assuming that the surface in **Figure 12-5** approximates the X-Z plane of the strain ellipsoid, and that foliation is perpendicular to this surface, plot the (X, Y, Z) directions of the total finite strain ellipsoid on the stereonet. Assume that the reference line in **Figure 12-5** is the strike of the foliation, and that the dip of the foliation is 25SW. Plot and label the foliation plane and the X-Z plane on the stereonet as great circles

### Problem 2

In **Figure 12-6** are the traced and numbered outlines of deformed pebbles in a sample (CA-23) of the Cheaha Quartzite. At the outcrop where this sample was collected the foliation attitude was N10E, 35SE. In **Figure 12-6**, two parallel sides of the slabbed sample are traced so that you can measure the X/Z ratios on both sides. Note that the trace line of the  $S_1$  foliation is to be used as the  $\Phi$  reference line on both faces of the sample. The sides of the slabbed sample are to be assumed to be cut perpendicular to  $S_1$  foliation. In addition, you are to assume that the trace of  $S_1$  on both sides of the slab in **Figure 12-6** are parallel to the strike line (N10E) of foliation. Use the hyperbolic net to calculate  $R_S$  and  $\Phi_S$  for the deformed pebbles. Use a table organized as in Problem 1 to report your measurements. From those measured values, calculate the dimensions of the total finite strain ellipse assuming plane strain and a starting reference sphere with diameter equal to 1.0. Calculate the stretch values parallel to the X and Z directions, and plot the (X, Y, Z) axis attitudes of the finite strain ellipse on the stereonet. Also plot the "slab plane" and the foliation lane as great circles, and

label them on the stereonet. Calculate the values of  $\lambda$ ,  $S$ ,  $\gamma$ ,  $\Psi$ , and  $\alpha$  for a line in **Figure 12-6** parallel to the long axis of pebble #25.

## EXERCISE 12B: Strain Analysis

Problem 1: Given the **Figure 12-8** photograph of a meta-conglomerate exposure, measure the length/width ratio of the strain markers and generate:

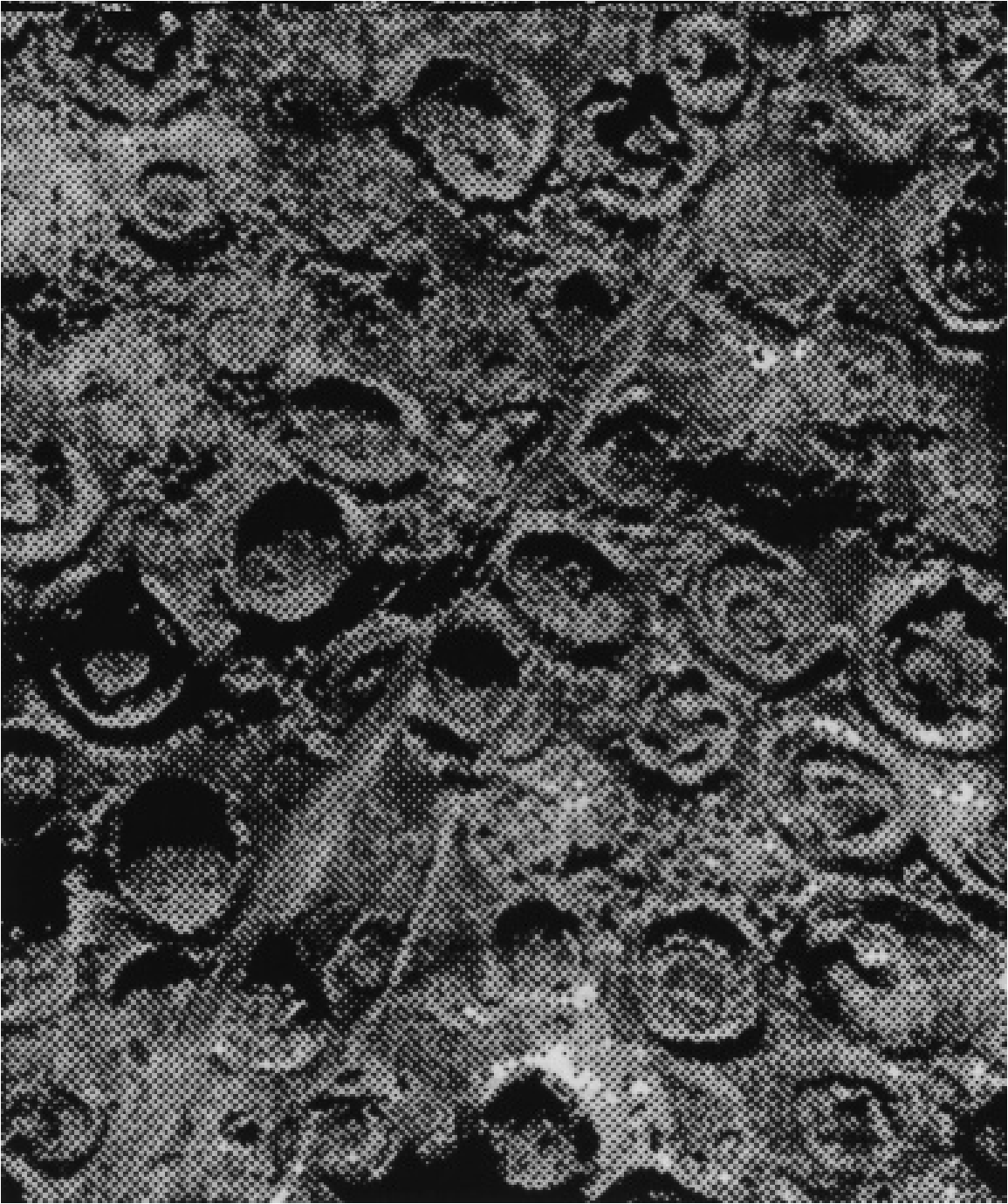
- a. Spreadsheet that tabulates the length, width, and RF. Use the cleavage trace as the reference.
- b. Hyperbolic net plot (**Figure 12-7**) with finite strain ellipse and RF indicated.

Problem 2: Plot the dimensions and orientation of the finite strain ellipsoid on the meta-conglomerate photo at any convenient location. Use Paint Shop Pro to retro-deform the photograph to its pre-deformation geometry. To retro-deform the image follow these steps:

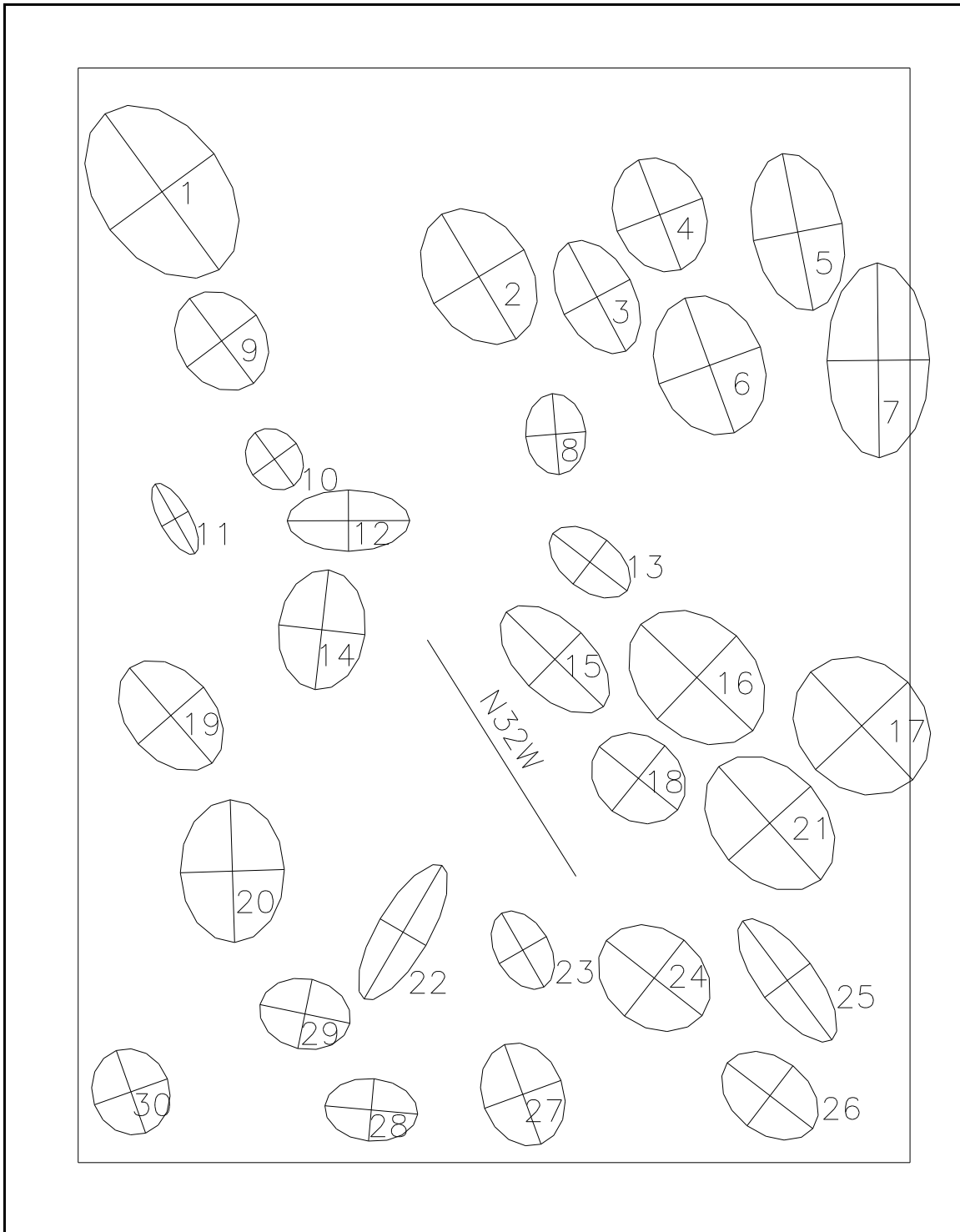
Step 1: Plot the finite strain ellipse on the image. The major axis should be oriented according to the finite strain ellipse angle calculated in problem 1. You can make the ellipse any convenient size-just make sure that the Rf ratio calculated in problem 1 is preserved.

Step 2: Scan the meta-conglomerate photograph with the finite strain ellipse plotted on it. Load the image into Paint Shop Pro and then use the "Image > Rotate > Free Rotate" menu option to rotate the major axis of the finite strain ellipse parallel to the horizontal. Turn on the window rulers with "View > Rulers". Note the horizontal length of the image on the ruler.

Step 3: Use the select tool to highlight the entire image. Use the far right handle and the select tool to drag the image to the right until the major axis is shortened to match the length of the minor axis. The minor axis should be vertical so it should not change its length. Use the ruler to make sure the major axis matches the length of the minor axis. The finite strain ellipse should now be a perfect circle. The image is now retro-deformed so its appearance now is the same as the pre-deformation shape. Print this image to turn in as the problem 2 answer. Make sure the finite strain ellipse- now a circle - is labeled clearly.

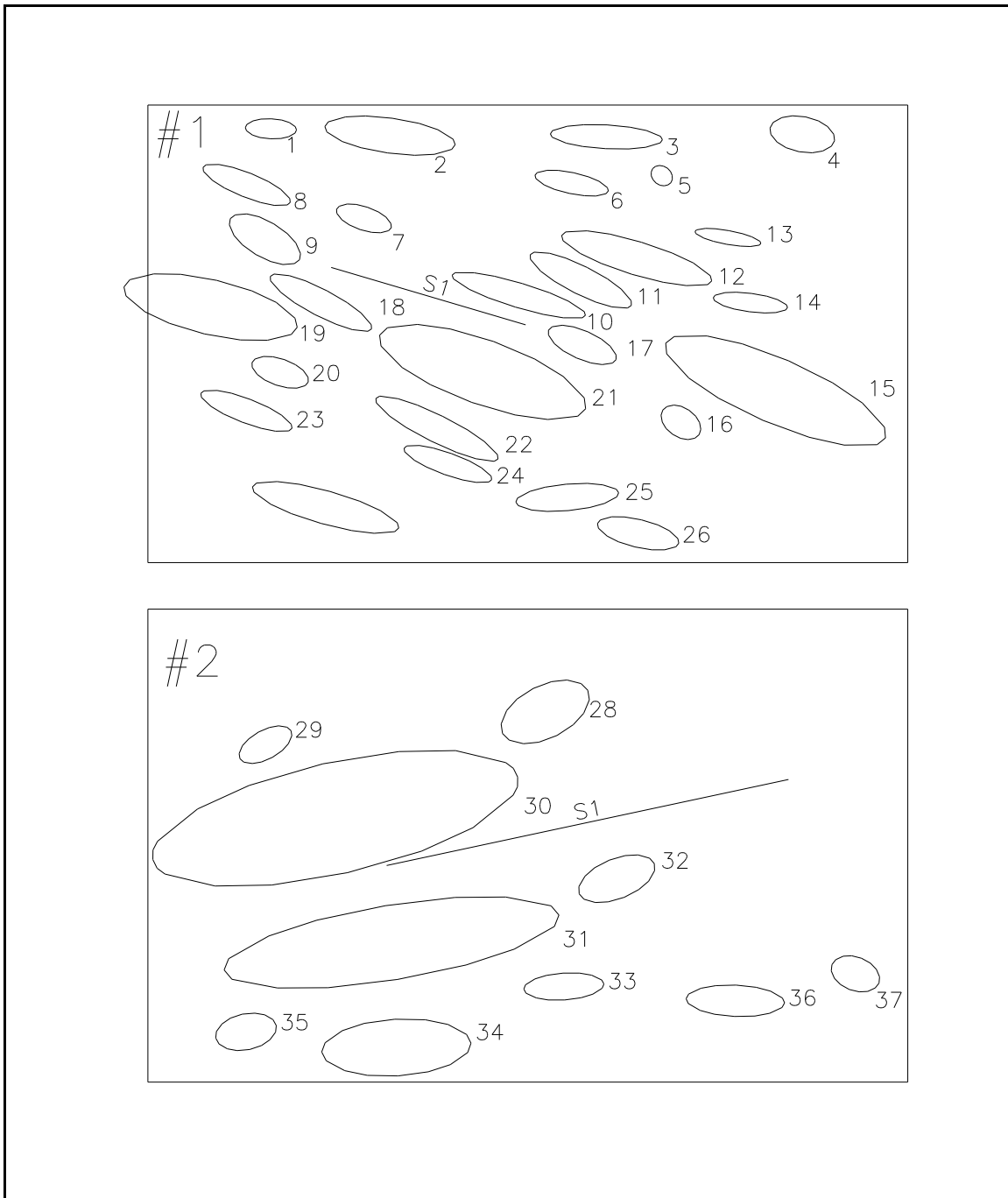


**Figure 12-4** : Scanned photograph of deformed ooids in limestone.



**Figure 12-5 :** Tracing of the deformed ooids in Figure 12-4. Use this to calculate  $R_F$  and  $\Phi$ .





**Figure 12-6** : Tracing of deformed pebbles in Cheaha Quartzite. Two parallel faces of the same sample (CA-23) are displayed.

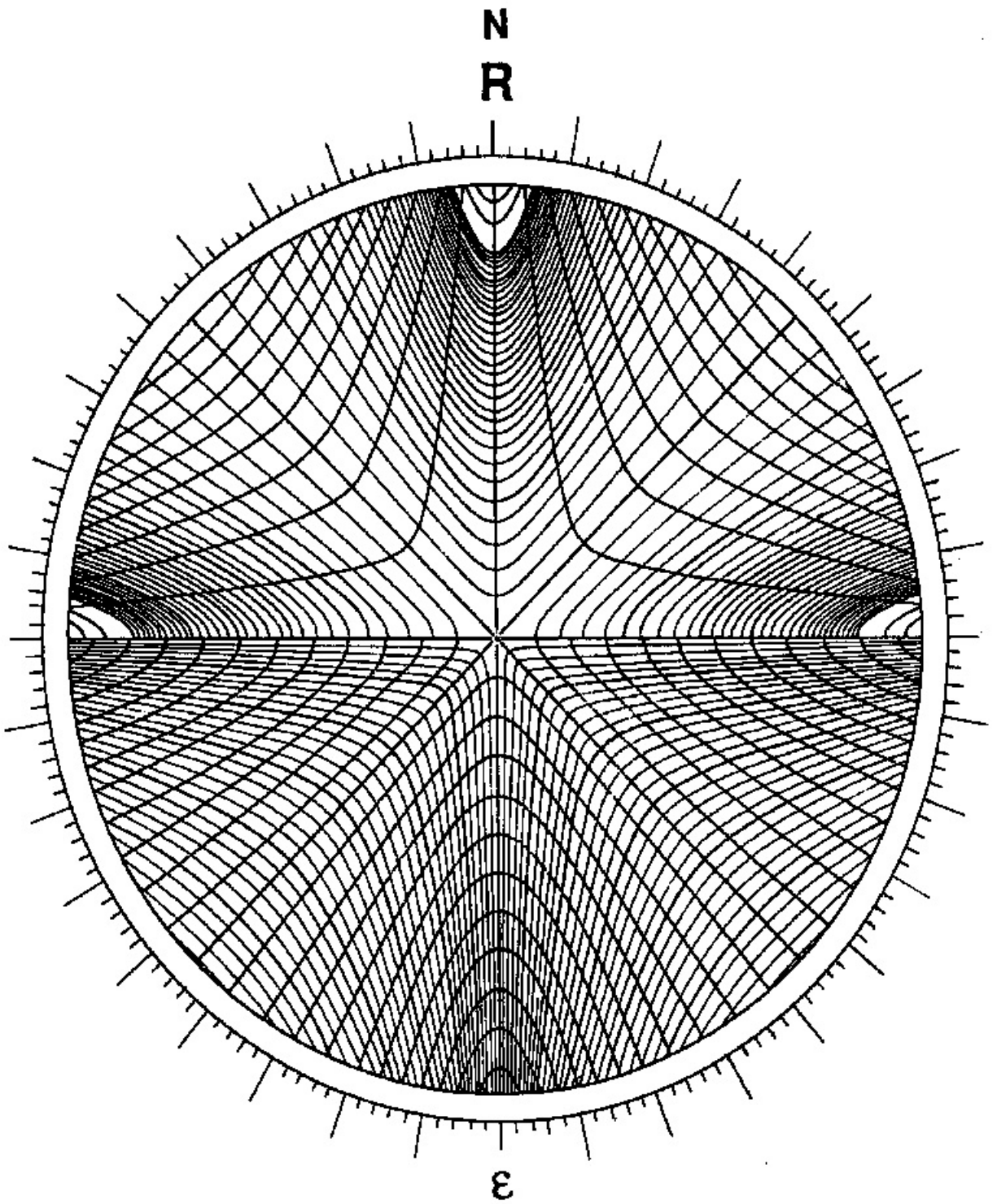
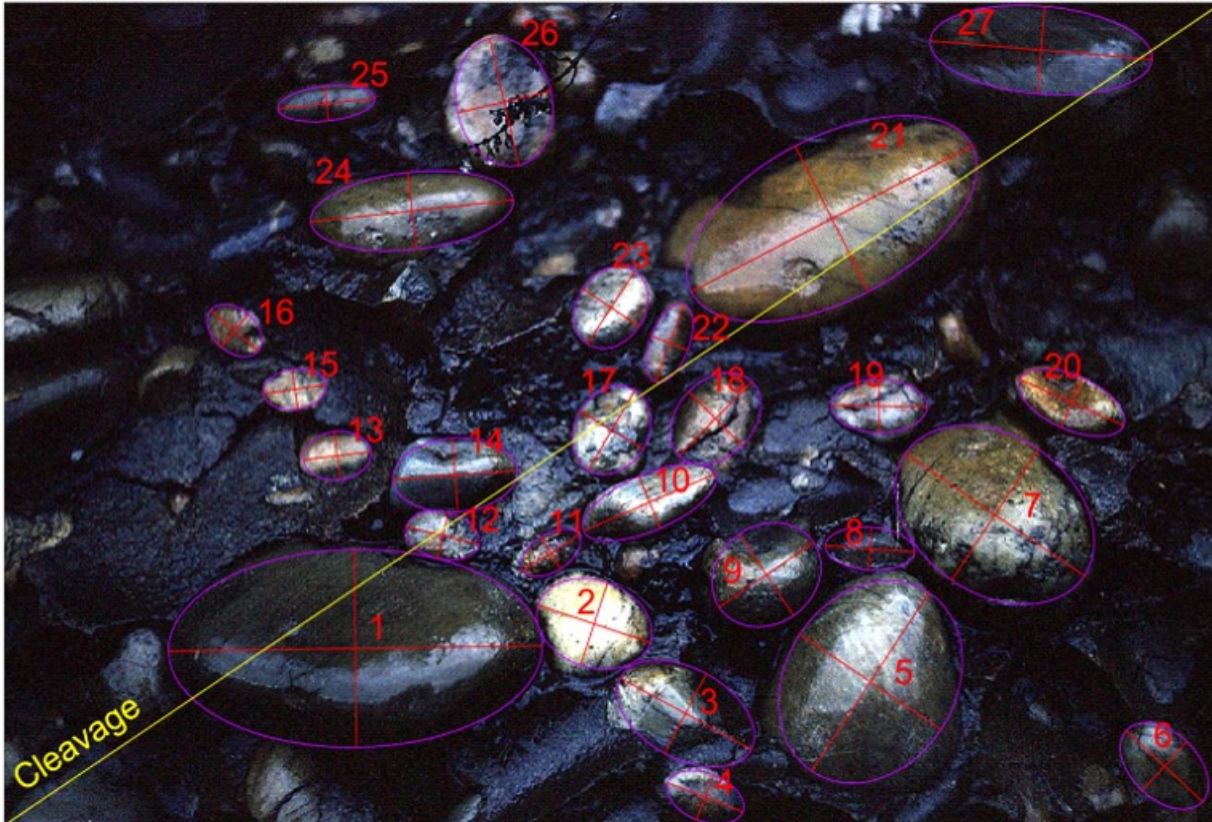


Figure 12-7 : Hyperbolic stereonet.



**Figure 12-8** : Photograph of deformed pebbles in a metaconglomerate with the cleavage direction indicated.

## LABORATORY 13: Fault Displacement Vectors

### I. Introduction to *Fault Translation*

A) If there is no rotational component to a fault motion every point in the displaced mass of rock is translated along vectors that are everywhere equal in magnitude and direction. This condition is referred to as pure *rigid-body translation*.

B) Note that if we are assuming a rigid-body deformation mechanism, there can be no *distortional* nor *dilational* component of strain internal to the fault block.

C) If the fault surface is not perfectly planar in the direction of net slip then the fault must have some component of *rotation*, however, we can often define the scale of the fault problem such that the amount of curvature is very small, therefore, the *rotational component* may be ignored.

### II. Apparent Translation (*Separation*)

A) Often the net slip vector of a fault is unknown because the offset geometries are planar, such as the trace of strata or dikes. Offset planes, by themselves, will never indicate the *net slip vector* unless additional information is available. Sometimes the intersection of two non-parallel structural planes provides a linear structure offset by the fault that allows for the calculation of net slip.

B) To determine the *net slip*, a linear structure must be identified in both fault blocks that was continuous before faulting. The vector that connects the *piercing point* of both linear elements defines the net slip vector if its direction and magnitude is measured within the fault plane.

C) When the structures that are offset by the fault are planar, the offset is *apparent* and must be classified as *separation* instead of slip. For example, if offset strata in the vertical wall of a quarry indicate hanging-wall down motion of 100 meters, the fault should be classified as having 100 meters of normal separation. The term separation indicates that, in this specific case, the normal fault motion is apparent and in fact could be purely strike slip translation. The reader should note that in most cases the geologist investigating a fault “sees” separation not slip- only later analysis in the office will provide an estimate of the net slip direction and magnitude using methods outlined below.

D) When the terms “reverse fault slip fault” or “right lateral strike slip fault” are used, you should assume that the person describing the fault translation has determined that the offset is true net slip and not apparent separation. However, proceed with caution on this

assumption because some geologists (who should know better), and virtually all engineers, erroneously classify faults with “slip” terms when all that is known about the fault translation is apparent separation from offset planar structures.

### III. *Net Slip*

A) The goal of any kinematic analysis of fault displacement is the solution of the net slip vector. Once the net slip vector is determined it is resolved into two components:

1. *Strike slip component*- that component of the net slip vector that can be projected to the strike line of the fault surface.

2. *Dip slip component*- that component of the net slip vector that can be projected to the down-dip direction on the fault surface.

B) Faults that have significant components of both the strike slip and dip slip vectors are termed *oblique slip* faults. Almost all natural faults are oblique slip although many have one or the other component dominating the oblique slip. The naming convention of oblique slip faults is as follows:

{minor slip component} {major slip component} slip fault

C) For example, if the net slip vector can be resolved into 500 meters of left-lateral strike slip and 100 meters of reverse dip slip, the fault is thus named as:

reverse left-lateral strike slip fault

D) In any kinematic analysis of the net slip, it is important to plot the attitude of the net slip vector since this the direction of travel of displaced points within the fault block that is considered to move relative to the other block. For example, if you were a geologist trying to find a linear ore body that was truncated by a fault, the attitude of the net slip vector would indicate the tunneling direction within the fault plane to find the offset continuation of the ore body in the adjacent fault block.

E) Some of the more common linear structures that are used to solve for net slip include the lines of intersection of non-parallel planes, fold hinges, river channel deposits, i.e. any linear structure that can be recognized in both fault blocks that was a continuous line before fault propagation. These include *angular unconformities* and intersecting dike phases.

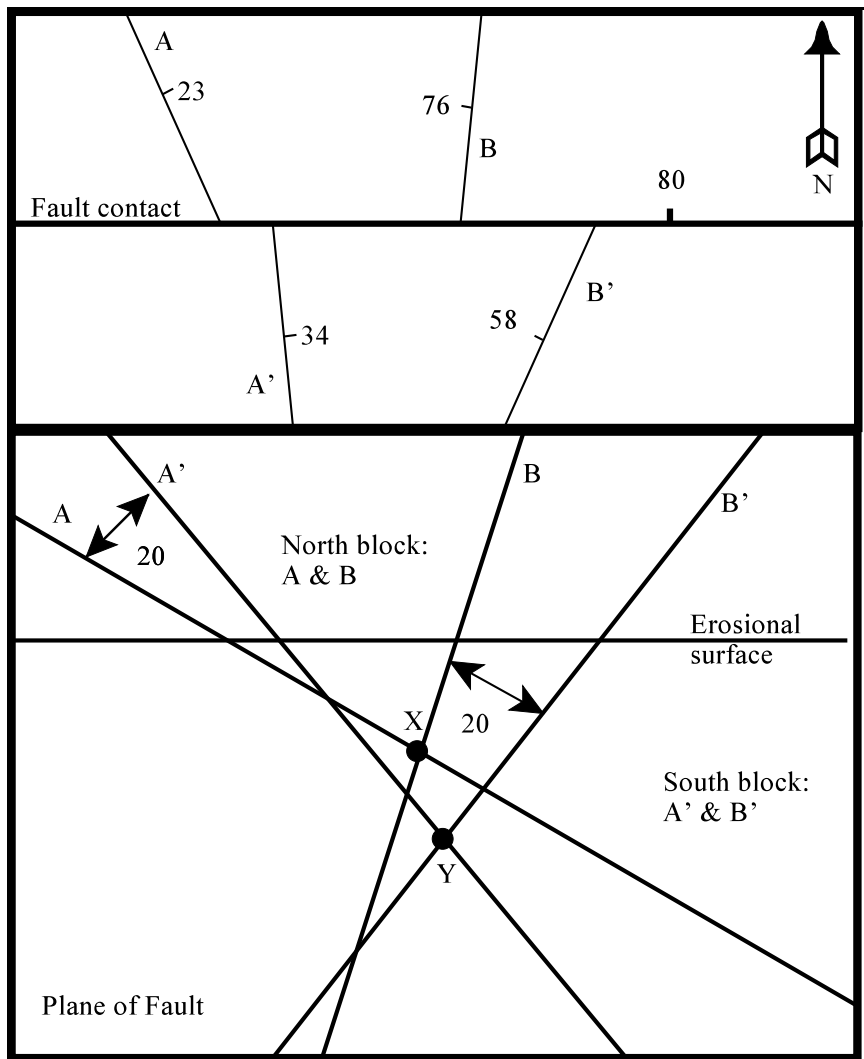
### IV. *Rotational Faults*

A) *Rotational faults* are usually easy to recognize because, unlike pure translational faults, they change the attitude of the same planar structure from one fault block to another. Pure translation may offset a planar structure, but it cannot change the attitude of the structure.

B) The goal of kinematic analysis of rotational faults is to find the point in the fault plane that is the piercing point of the *rotational axis*, and to find the *angular magnitude* and *sense of the rotation*. Note that, in all cases, the rotational axis must be perpendicular to a planar fault surface.

C) The angular amount of the rotation can be measured by plotting the trace of the same planar element as it exists in both fault blocks. The angle between the two traces represent the magnitude of the rotation. Inspection of **Figure 13-1** also determines that the sense of rotation from A to A' is clockwise. The same is true of B to B'. Since A and B are in the north block, and A' and B' are in the south, then the **clockwise rotation is the motion of the south block relative to the north block as view looking from the south block**

D) The position of the rotational axis in the fault plane can be found by finding a pair of points from both fault blocks that where superimposed before faulting (point X and Y in **Figure 13-1**). The point of rotation must lie along the *perpendicular bisector* of the line connecting these two points. The common point may be the intersection of two non-parallel dikes in a single fault block (see **Figure 13-1**). The exact position of the rotational axis piercing point must match the angular amount measured in (C), and must match the correct sense of rotation indicated by the traces of the offset planes. In **Figure 13-2** above, the rotational axis R2



**Figure 13-1** : Example of traces of rotated dikes A and B.

gives the correct clockwise sense of rotation for the displacement of X (north block) to position Y (south block) using the convention of keeping the north block motionless and inspecting how the south block was rotated relative to the north block as viewed from the south block. The reader should note that if we reverse either of the criteria, the viewing direction or the relative motion of fault blocks, the sense of rotation would be reversed.

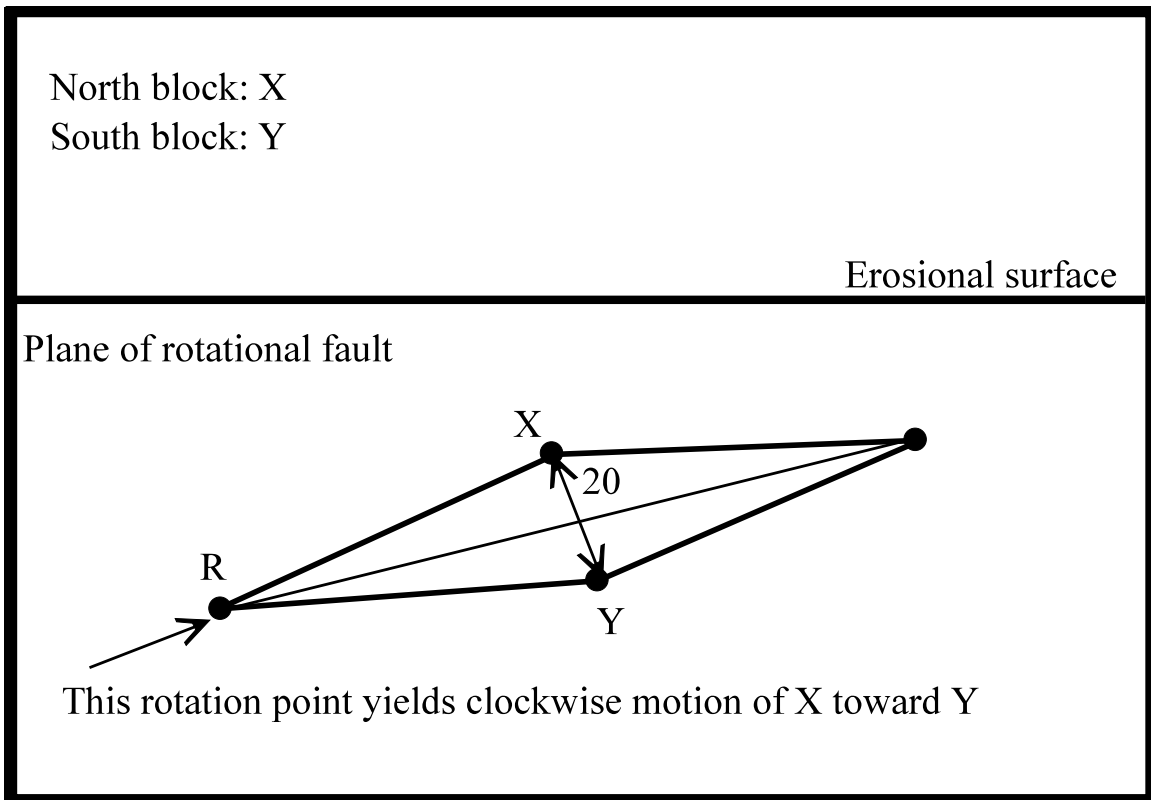


Figure 13-2 : Calculation of rotational axis position.

### EXERCISE 13: Fault Solutions

Problem 1. The plane of a normal-slip fault strikes  $N0^{\circ}E$  and dips  $60^{\circ}$  to the west. The fault displaces a structural plane ( $N90^{\circ}W, 30^{\circ}N$ ) which shows 100 meters of left-separation. What is the amount of the net slip? Report the amount and direction of the rake angle used to solve the problem on the stereonet.

SCALE: 1 inch = 100 meters

Problem 2. A fault ( $N90^{\circ}W, 60^{\circ}N$ ) cuts two structural planes: Plane 1= $N45^{\circ}W, 30^{\circ}NE$ ; Plane 2= $N50^{\circ}E, 45^{\circ}NW$ . The amounts and senses of separation are shown in **Figure 13-3**. What is the amount and orientation of the net slip; what are the dip-slip and strike-slip component magnitudes? Classify the fault according to minor-major slip sense of motion. Finally, calculate the rake angle of the net slip vector in the plane of the fault. Report the amount and direction of the rake angles used to solve the problem on the stereonet.

SCALE: see Figure graphical scale.

Problem 3. A fault ( $N30^{\circ}E, 60^{\circ}W$ ) displaces two planar dikes A and B as shown in **Figure 13-4**. What is the angle and sense of rotation of the fault motion? Locate the center of rotation which will account for the observed displacements, and label this point as "R". Determine the sense of rotation as viewed from the southeast block looking toward the northwest block, with the northwest block remaining static, and the southeast fault block rotating due to fault motion. Construct your fault plane cross-section with SW to the left, and NE to the right. Report the amount and direction of the rake angles used to solve the problem on the stereonet.

SCALE: see Figure graphical scale.

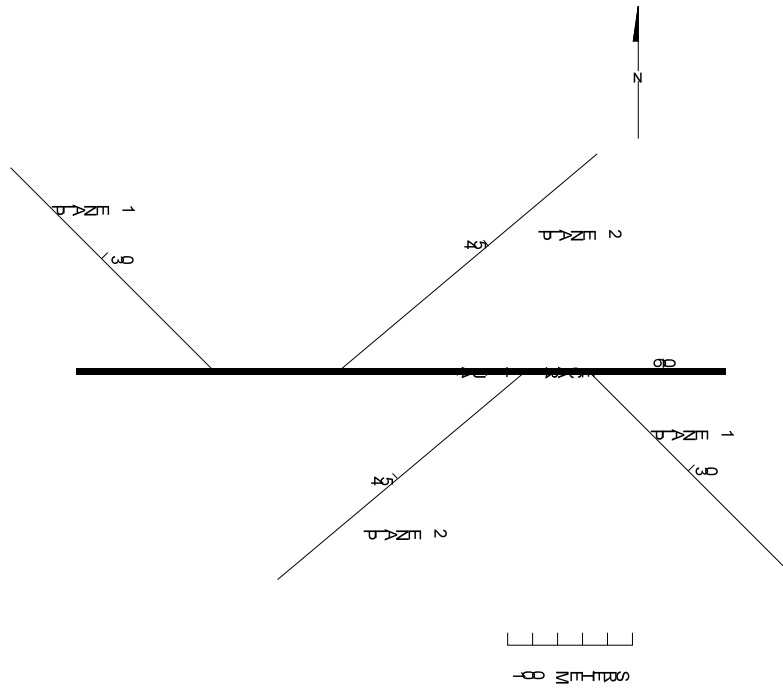


Figure 13-3 : Map for problem 2.

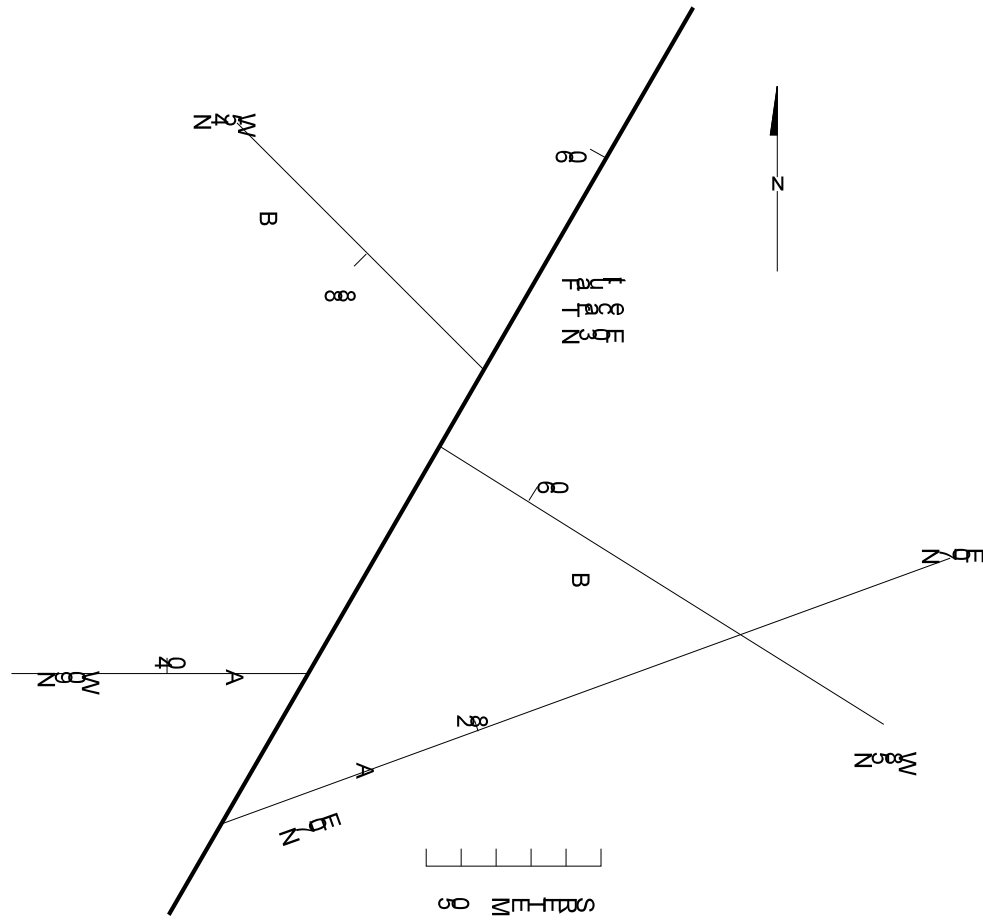


Figure 13-4 : Map for problem 3.



## LABORATORY 14: Down-plunge Fold Projections

### I. Introduction

The correct position in which to view a fold in profile is in the plane perpendicular to the hinge line of the fold. In other words, you should view the fold looking directly parallel to the hinge line. The reason that this is important is because viewing a fold in a plane oblique to the hinge will cause a true *parallel fold* geometry to appear to be *similar* in shape. Remember that similar and parallel geometries imply something about the origin of the fold:

*Parallel Fold*: a fold that maintains constant thickness measured perpendicular to the folded layer. The deformation mechanism implied by this geometry is slip along bedding planes which, in turn, implies that deformation is, to a large degree, a brittle phenomenon.

*Similar Fold*: a fold that maintains a constant thickness measured parallel to the axial plane of the fold. These folds thicken dramatically in the nose of the fold. The mechanism implied by this geometry is one of ductile flow. In other words, the layers that are folded were passive and played no part in the deformation mechanism that formed the fold.

A good example of this effect can be found in the fold and thrust belt of the Appalachian foreland in the southern Appalachians (the region centered around Birmingham, AL). The folds in the foreland are parallel geometries in profile, yet, if you observe them in map view they appear to thicken dramatically in the nose of the fold. The apparent similar geometry has nothing to do with the fold mechanism but is instead due to the fact that the erosional surface makes a low angle with the hinge of the plunging folds in this region. In fact, the plunge of the folds are often less than 5 degrees northeast or southwest. To view the folds in a true profile, one would have to project the map image to a plane that is oriented perpendicular to the fold hinge.

### II. Constructing the Down-Plunge Profile Plane

It is always possible to construct the plane of the profile in two alternative but geometrically correct modes. The plane may be constructed as one would view the profile in a down-plunge or up-plunge direction. Neither one is more correct but one should clearly label the strike direction of the profile so that the viewer may correctly orient the diagram. The most common way to proceed is to construct a down-plunge profile panel therefore the name "down-plunge" projection.

**Figure 14-1** displays a complete down-plunge projection construction. The given information is the geologic map containing a folded layer, and the hinge attitude indicator (30, S0E). The construction was completed with the below steps:

1. Draw a rectangular grid across the fold using a convenient scale. The actual value of the

grid size is not important. The grid must be orthogonal to the bearing of the hinge. The base line of the grid should be the grid line perpendicular to the bearing of the hinge and farthest in the plunge direction. Number all grid lines parallel to the baseline (1-5 in **Figure 14-1**). Remember that the baseline must not cross the fold structure of interest.

2. In this step we construct the grid for the plane of the projection. In **Figure 14-1** the easternmost north-south grid line is labeled as a fold line. Along the fold line are several arrows indicating the hinge plunge. Note that if we extended the grid lines on the map surface parallel to the hinge that they would project to the plane perpendicular to the hinge at a spacing of:

$$\sin 30 = \frac{x}{1.0}$$

where X is the spacing of the projection plane grid. Thus the spacing of the grid lines must be 0.5 units apart in the projection plane in this specific example. Measure grid lines parallel to the baseline that are 0.5 units apart and match the number of equivalent east-west grid lines on the map surface. These are labeled as 1' through 5' in **Figure 14-1**.

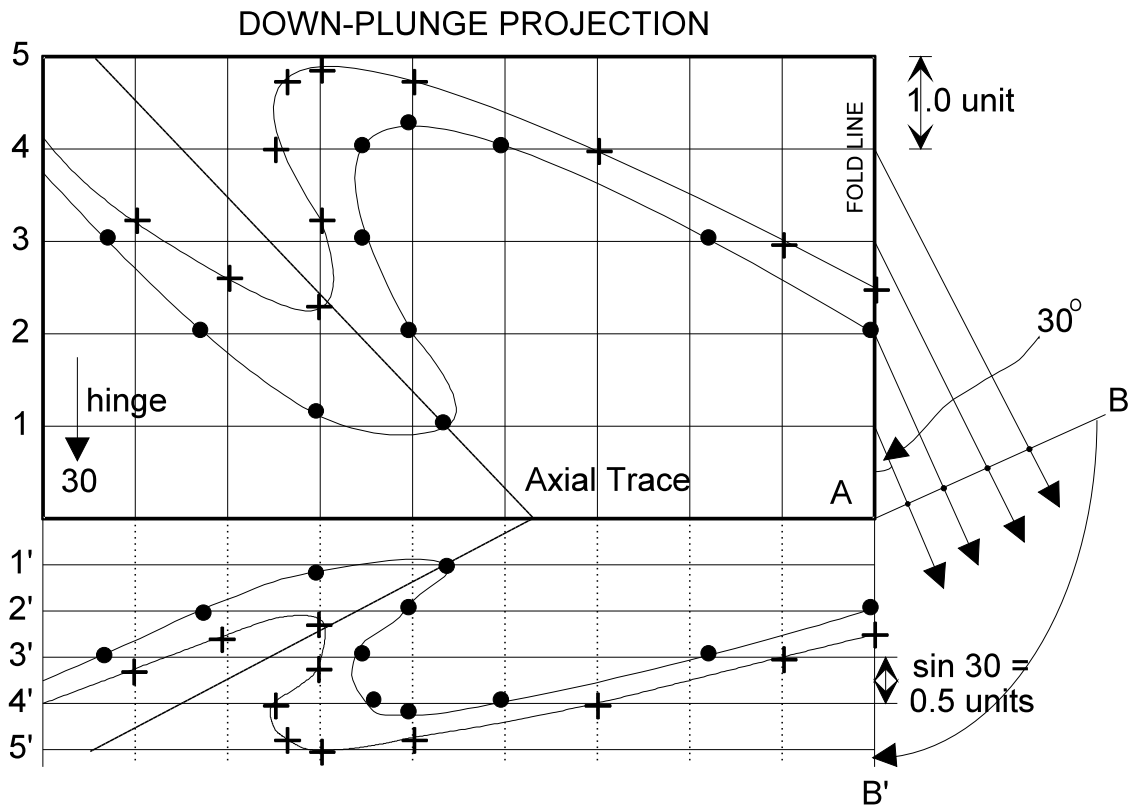
3. After constructing the profile grid, one should identify convenient points on the map surface where a folded layer crosses a grid line. These points are marked with dot and cross symbols on the map surface in **Figure 14-1**. As you follow one of the folded layers, project each point parallel to the hinge bearing to the equivalent position on the projection plane. After sufficient numbers of points are projected for a layer you can "connect the dots" to form the folded layer in the projection plane.

4. Complete step (3) above for all layers that are on the map. Don't forget to label the ends of the projection baseline with the correct bearings. The projected folds must obey that rules of plunging folds- antiforms are convex in the direction of plunge, whereas synforms are concave in the plunge direction. Make sure that all of the projected folds obey this rule. Also note that in **Figure 14-1**, more points are needed to correctly trace the portions of the fold that have high curvature near the hinge zones. You can interpolate as many points as you judge necessary to define the fold.

5. Using the legend from the geologic map, color or pattern the layers on the profile to match the information from the map.

With the true profile of the fold it is now possible to correctly interpret the fold mechanism from the fold geometry. In **Figure 14-1**, the axial trace of the fold on the map surface and within the profile plane is marked by the dashed line. This information could be used to estimate the attitude of the

axial plane since the attitude of the profile plane is known (plane perpendicular to the hinge), and the rake angle of the axial trace in the profile plane could be directly measured with a protractor.



**Figure 14-1** : Down-plunge projection construction.

## EXERCISE 14: Fold Projection

Problem 1. Construct a true fold profile using the **Figure 14-2** that is included with this exercise. Assume that the structural plunge (fold axis) of folding is  $15^\circ$ ,  $S65^\circ W$ . Assume that the topographic relief in this area is negligible. After constructing the fold profile, describe the nature of the fold mechanism (parallel or similar?), and compare that to the apparent fold mechanism as judged from the map pattern. Construct the projection so that the profile is down-plunge, and the southeast end of the profile is on the right side of the construction. Although the lithologies in **Figure 14-2** are indicated with patterns, you are to color the down-plunge fold profile:

Schist = White (no color)

Marble = Light blue

Quartzite = Yellow

Gneiss = Dark Red

Note that the map scale is metric. Turn in the profile as an inked copy on vellum. You may use a sheet of vellum larger than 8.5x11 inches if you wish.

SCALE: see graphical scale on figure.

Problem 2: With the information from the down plunge projection estimate the axial plane attitude of one of the folds labeled "X" on your geologic map. Draw the trace of the axial plane of this fold on the projection and label it with the rake angle value. Plot this information on the stereonet and calculate the attitude of the axial plane.

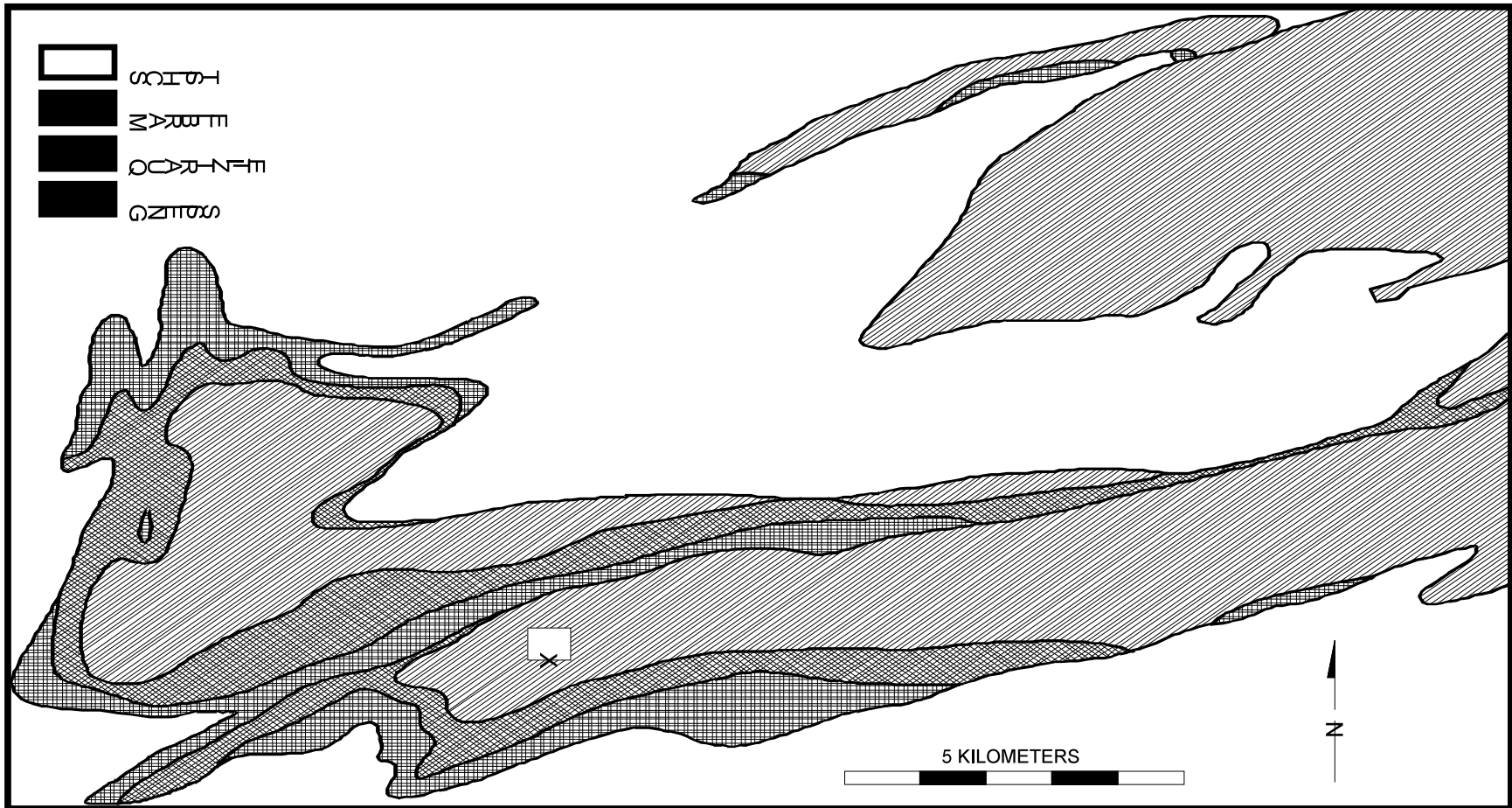


Figure 14-2 : Map for problem 1 projection.

## LABORATORY 15: Constructing Geologic Cross-sections from Geologic Maps.

### I. Introduction

A geologic cross-section is used to depict the subsurface structure of a mapping area based on the geometry of the geologic map. Although some of the cross-section may be based on extrapolation, as much as possible should be quantified based on the geometry of the geologic map, including the attitude of map-scale fold axes in folded terranes. Obviously the geologic map and stereographic statistical analysis should be completed before the cross-section is constructed.

### II. Cross-section Constraints

The geologic map will have lines labeled “A” to “A” or “B” to “B” that indicate the position of the cross-section line. The topographic profile should be constructed from the topographic contours crossing the line of the cross-section. Although for some purposes vertical enhancement may be used to emphasize topographic relief, if this is done the apparent dips of geologic structures must also be recalculated, therefore, this is generally avoided. Use the same vertical scale as the horizontal map scale if no vertical enhancement (i.e.  $VE = 1.0$ ) is desired. If computer applications are utilized to construct the cross-section it is not unusual that contours have different units than X,Y coordinates remember to convert units. For example, if the coordinate system is UTM the X,Y coordinates will typically be meters, whereas the contours on 1:24,000 scale maps are in feet. The elevations should be converted to meters for  $VE=1.0$ .

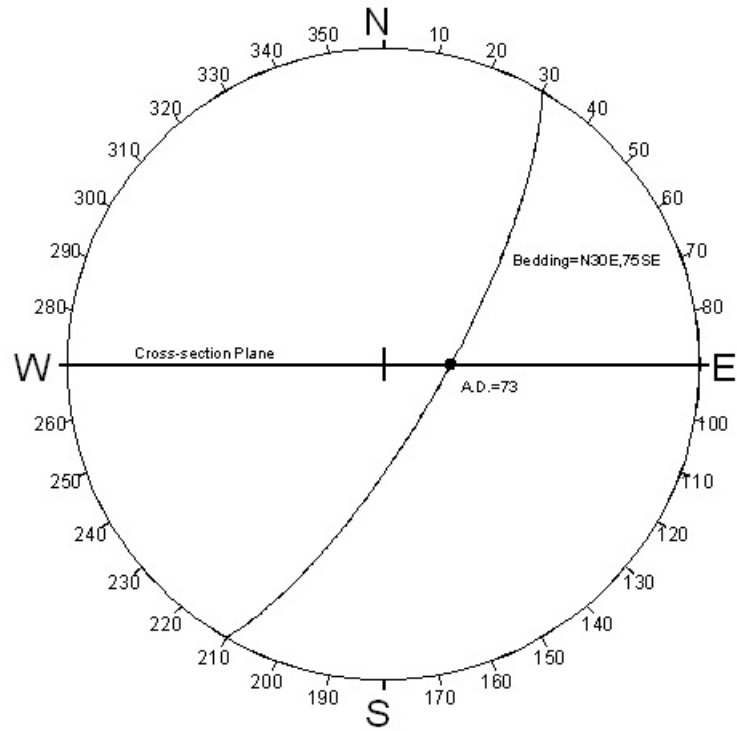
### III. Cross-Section Construction Rules

Step 1: Construct the cross-section grid and topographic profile first. Label major topographic, geologic and geographic features on the profile for reference (i.e. rivers, faults, mountain peaks, towns, etc.). It is often useful to label the vertical scale on one side in meters and the other side in feet.

Step 2: Align a sheet of paper against the line of the cross-section. Mark the ends of the cross-section with “A” and “A” (or whatever is appropriate). In addition mark the position of every geologic contact that crosses the cross-section line. With a stereonet calculate the apparent dip of the contact relative to the cross-section line (see explanation below; **Figure 15-1**) . Draw the inclined contact line using this apparent dip angle from the point marked on the edge of the paper keeping in mind the correct dip direction (**Figure 15-2**). If there is no strike and dip marker for the contact near the cross-section line then the strike and dip must be estimated using the outcrop trace and topography. Remember that en echelon or conjugate faults often have similar attitudes. Label the opposite sides of the contact with the lithologic code for the units on each side of the contact. If the contact is a major fault make sure to label the fault with its name.

Step 3: Align the sheet of paper used in (Step 2) along the cross-section grid horizontal axis constructed in (Step 1). Make sure that the correct ends of the cross-section are used during the alignment. Project the contacts from the (Step 2) paper straight-up vertically to the topographic profile line, and draw in the apparent dip. Only project the apparent dip a few tenths of an inch into the subsurface. Remember that the attitude may change quickly, or the contact may be truncated depending on folding, faulting or angular unconformities. Label the opposite sides of the contact with the correct lithologic code.

Step 4: Finish sketching the cross-section lightly in pencil keeping in mind that it is typical to modify the contacts several times before deciding on a final product. If the cross-section contains major faults/unconformities it is advisable to sketch the fault/unconformable contacts in first since stratigraphic contacts will truncate against the fault/unconformity. Drag folding may occur near fault contacts. Make sure that arrows of relative displacement are used on fault contacts. Fault contacts should have thicker line work. Stratigraphic thickness should be preserved unless there is evidence for map-scale ductile deformation. If plunging fold hinges are present on the geologic map the statistical plunge attitude of the hinge should be used to project the hinge point of a contact to the cross-section profile



**Figure 15-1** : Example of apparent dip calculation for a vertical cross-section.

(see below discussion). Some speculation may be used. For example, even though granite basement rocks may not outcrop on the geologic map, if drilling in the area has confirmed the thickness of Paleozoic strata, and the vertical extend of the cross-section indicates that the base of the Cambrian should appear, it is expected that the Precambrian basement should appear below the Cambrian strata. Speculative contacts should be dashed as on the geologic map. Speculative contacts are often projected into the “air” above the topographic profile to display a complete structural interpretation of folding and/or faulting.

#### IV. Apparent Dip Calculation.

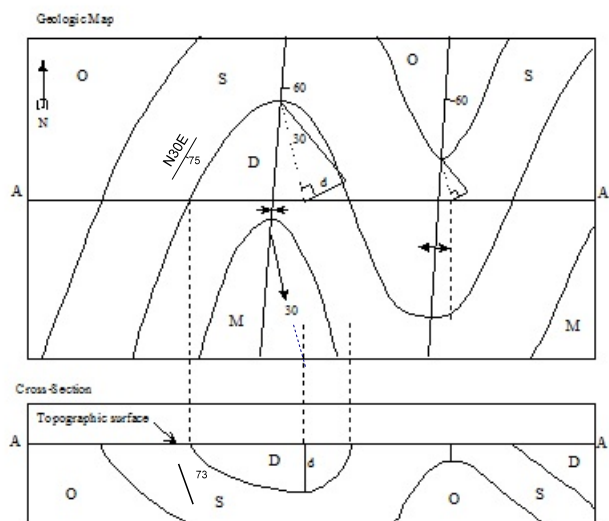
The apparent dip of a contact in the cross-section is easily calculated on a stereonet. First, plot the

attitude of the cross-section as a vertical plane on the stereonet (**Figure 15-1**). The strike of the cross-section is the end that trends to a north quadrant, and the dip is always 90. A vertical dip always plots as a straight line on the stereonet. Label the cross-section great circle so that it is not confused with some other attitude. Note that if the strike of the contact is close to or 90 degrees to the trend of the cross-section, the apparent dip is equal to the true dip of the contact. Plot the attitude of the contact as a great circle. The intersection of this great circle with the cross-section will produce a point. The rake angle of this point measured in the plane of the cross-section is the apparent dip to be used on the cross-section. Be careful to correctly note the correct end from which the apparent dip is measured and use the same end when plotting the contact on the cross section. For example, suppose that a contact near the cross-section line measured 030, 75SE is to be projected to a cross-section line with a 090, 90 attitude (see **Figure 15-2**). The apparent dip measured from the stereonet is 73 from the east end of the cross-section line. Therefore, the apparent dip is 73 with a trend of 090. Note that the apparent dip is always less than the true dip.

Along the line of the cross-section typically there will be contacts that have been mapped to cut across the cross-section line, however, there may not be any attitude measurements nearby to use in the apparent dip calculation. In these cases it will be necessary to estimate the strike and dip using the outcrop trace of the contact and the topographic contours. This in effect is a 3-point type problem as described in Laboratory 1. If 2 points on the trace of the contact with the same elevation can be found near the cross-section, the line connecting these 2 points will be the strike of the contact. The geological contact “Rule of V’s” will indicate approximately the dip amount and direction if a quantitative 3-point problem cannot be attempted. See the discussion of outcrop patterns in the “Outcrop Prediction” chapter.

## V. Map-Scale Fold Hinge Projection

A properly constructed cross-section must take into account the full extent of the geologic map from which it is constructed. For example, consider the geologic map and cross-section in the **Figure 15-2** example. Note that the contacts that cross the A to A’ line are projected perpendicular to the line from the map to the equivalent topographic surface point. When the Silurian/Devonian contact in the plunging syncline is considered it is evident that the hinge point will project down-plunge to the



**Figure 15-2** : Example of the geometry of plunging folds and cross-section.

cross-section but at what depth below the topographic surface? This depth can be calculated graphically or mathematically with the trend and plunge of the fold hinge. In **Figure 15-2** the Siluro-Devonian contact hinge point is projected along the trend of the hinge until intersecting the A-A' line. A perpendicular line to this line is constructed so it intersects the plunge angle line constructed from the hinge point origin defines the structural depth (d) below the topographic surface for the synclinal hinge point. This point is projected perpendicular to the cross-section line to the equivalent position on the cross-section topographic surface, and then at a depth (d) below the surface. This point is used to constrain the depth of the Siluro-Devonian contact in the cross-section. Note that the hinge attitude should be calculated from stereographic analysis of bedding from the fold area.

## Exercise 15A: Geologic Cross-Sections

Problem 1: Construct a geologic cross-section along line A - A' on the Geologic Map of the Wyndale and Holston Valley Quadrangles, Virginia (**Figure 15-3**). Use a horizontal and vertical scale of 1:24,000 (1 inch = 2000 feet). Consult with your instructor for drafting media for this project. The paper should be at least 12 x 18 inches for completing the project. The original map and a beginning cross-section will be displayed in an area accessible to students. Use the strike and dip of bedding as data for a stereonet that determines statistically the plunge and bearing of map-scale fold hinge lines. Use the **Figure 15-4** A - A' grid as a starting point. Turn in the stereonet used to calculate the hinge attitude of folding from the geologic map. Refer to the **Figure 15-2** example for projection methods. Turn in the stereonet(s) used for calculating the statistical hinge attitude with your cross-section.

General Cross-section Guidelines: the below guidelines are generally followed when constructing geologic cross-sections.

1. Use the same scale for horizontal and vertical scales (V.E. = 1.0) unless you have a very good reason for doing otherwise. If the V.E. is something other than 1.0 you must correct all apparent dip and plunge angles for the distortion.
2. Sedimentary units that project to the cross section should retain their proper thickness in the subsurface unless there is geophysical or drilling data to the contrary.
3. The projection of major structural features such as fault contacts or fold hinges should be quantitatively determined from the attitude of the feature on the geologic map even if the structure does not actually cross the cross section line.
4. It is standard practice to use the known regional stratigraphic column to “interpret” subsurface structure.
5. Fault contacts are displayed as thicker line work just as they are on the geologic map. It is normal practice to assume fault-drag folding in the subsurface to explain the cross section structure. If relative fault displacement can be determined on the geologic map it should be reflected in the cross section. Use relative displacement arrows to show fault separation - do not use linework symbols (teeth, hachures, etc.).

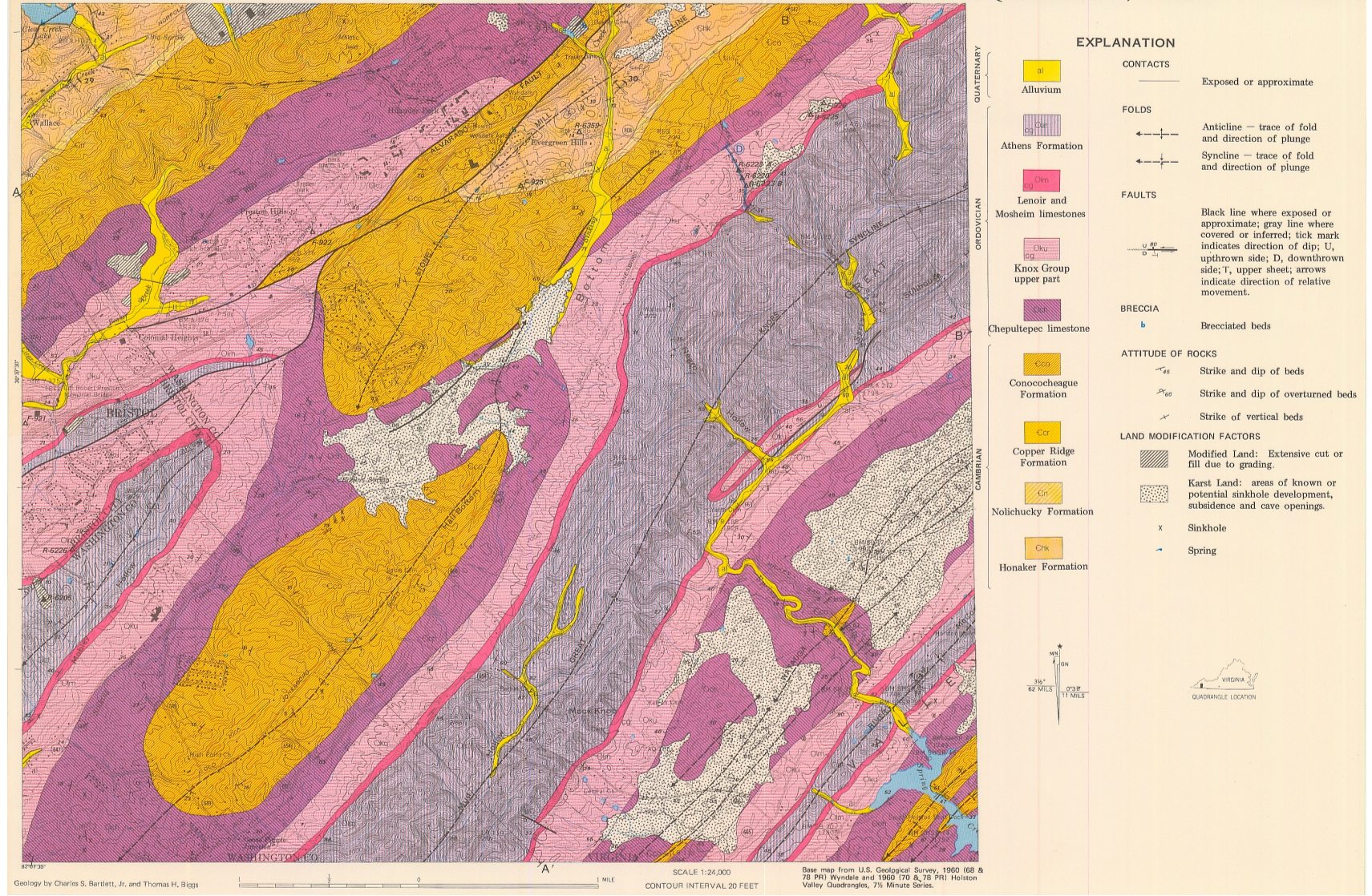
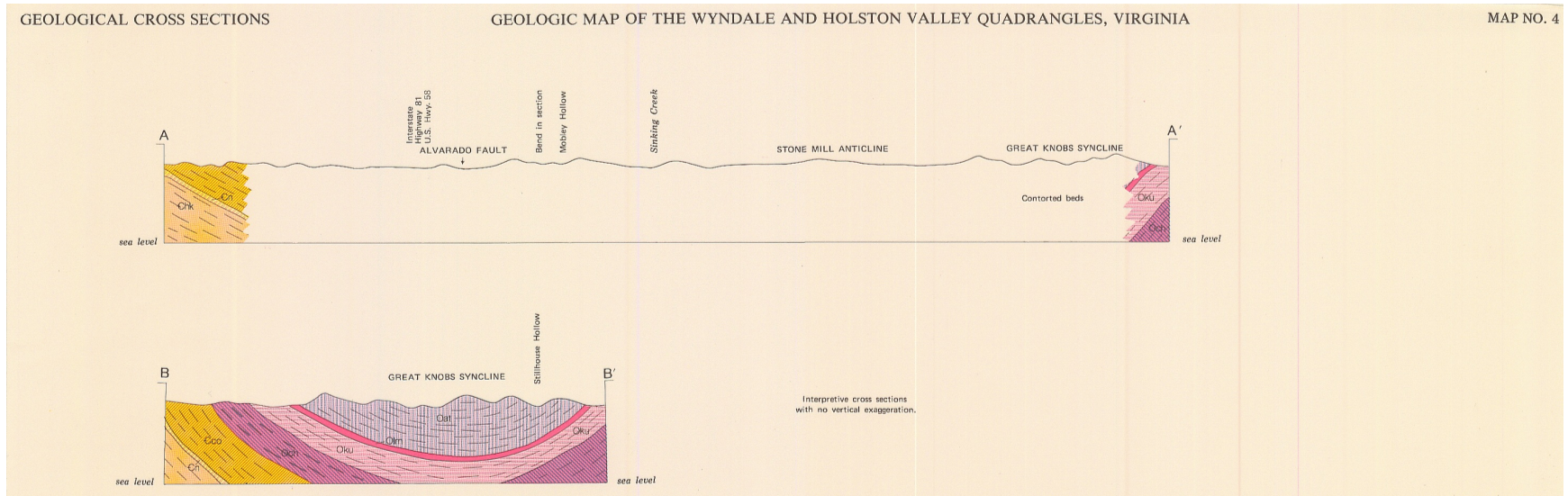


Figure 15-3 : Geologic Map of the Wyndale and Holston Valley Quadrangles, VA.



**Figure 15-4 :** Geologic cross-sections of the Wyndale and Holston Valley Quadrangles, VA.

## BIBLIOGRAPHY

Davis, John C., 1986, Statistics and data analysis in geology: 2nd ed., John Wiley & Sons, New York , 646p.

Marshak, Stephen and Mitra, Gautam, 1988, Basic methods of structural geology: Prentice Hall, Englewood Cliffs, New Jersey, 446p.

Ramsay, John G., 1967, Folding and Fracturing of Rocks: New York, McGraw-Hill, 568p

## INDEX OF TERMS

Dip azimuth and Dip angle.....	1-4
$\alpha$ .....	1-8, 12-3
$\gamma$ .....	12-3
$\theta_d$ .....	12-3
$\lambda$ .....	12-3
$\sigma_1$ .....	11-1
$\sigma_2$ .....	11-1
$\sigma_3$ .....	11-1
$\Phi$ .....	12-2
$\Phi_S$ .....	12-2, 12-3
$\Psi$ .....	12-3
alidade.....	1-6
angular magnitude.....	13-3
angular unconformities.....	13-2
angular unconformity.....	1-14
Anticline.....	6-3
antiform.....	1-14, 5-5, 6-3
antiformal syncline.....	1-14, 6-3
apparent.....	13-1
Apparent dip.....	1-1
Apparent Thickness.....	8-1
Apparent Width.....	8-1
Asymmetric fold.....	6-3
attitude.....	1-1
Axial Plane.....	4-1, 6-1
Axial Trace.....	4-2
Azimuth.....	1-1, 1-3
Basin.....	1-15, 6-3
bearing.....	1-1, 1-5
Bedding.....	6-1
best-fit vector.....	10-1
Beta ( $\beta$ ) diagram.....	5-4
Brunton Compass.....	1-6
circular sections.....	11-1
Cleavage.....	6-1
clinometer.....	1-6

closed traverse. . . . .	6-4
Coefficient of Determination. . . . .	10-8
compositional layering. . . . .	6-1
confidence region. . . . .	10-1
Conical. . . . .	5-4
Conical distribution. . . . .	10-1
conjugate fractures. . . . .	11-2
contour interval. . . . .	9-2
counting node point. . . . .	5-2
Cross section. . . . .	1-1
crossbedding. . . . .	4-2, 6-1
curvilinear. . . . .	1-2
Cylindrical. . . . .	5-4
Cylindrical girdle. . . . .	10-1
degrees of freedom. . . . .	10-9
Depositional contacts. . . . .	6-2
dilation. . . . .	12-1, 13-1
dip. . . . .	1-3
dip angle. . . . .	1-3
Dip direction. . . . .	1-2
Dip slip component. . . . .	13-2
Dip-slip fault. . . . .	1-17
directional cosines. . . . .	10-1
disconformity. . . . .	1-14
distortion. . . . .	13-1
Dome. . . . .	6-3
Doubly-plunging. . . . .	6-3
ellipsoid. . . . .	12-2
Equal-angle. . . . .	3-1
Equal-area. . . . .	3-1
Fault Contacts. . . . .	6-2
Fault Translation. . . . .	13-1
finite strain ellipse. . . . .	12-1, 12-2
flexural-slip. . . . .	5-4
Fold Axis. . . . .	4-1
Fold Hinge. . . . .	4-1, 6-1
Fold Limb. . . . .	1-14, 4-2
Fold symmetry. . . . .	6-1

Foliation.....	6-1
footwall. ....	1-18
foreset beds. ....	4-2
graded bedding.....	6-1
great circle. ....	3-1
Great circle girdle.....	5-4
hanging wall.....	1-18, 6-2
homogenous plane strain. ....	12-1
horizontal attitude. ....	9-1
hyperbolic net.....	12-2
igneous contacts.....	6-2
Inclination. ....	1-2
Index of Terms.....	1-2
Interlimb Angle. ....	4-2
Intersection lineation. ....	6-1
isoclinal. ....	5-5
joint sets.....	6-2
K angle.....	10-1
Kalsbeek counting net. ....	5-2
L1.....	6-1
Latitude. ....	1-1
least-squares.....	10-1
left lateral. ....	1-17
Lineation. ....	1-2, 6-1
lithostatic stress. ....	11-1, 11-2
Longitude.....	1-1
lower-hemisphere projection. ....	3-1
magnetic declination. ....	1-6
mean vector. ....	10-1
Megascopic. ....	6-2
Megascopic Fold. ....	6-2
Mesoscopic. ....	6-1
Mineral lineation. ....	6-1
Mohr Circle Diagram.....	11-1
Mohr fracture.....	11-1
net slip. ....	13-1
net slip vector.....	13-1
neutral. ....	6-3

nonconformity. . . . .	1-14
normal dip slip. . . . .	1-18
Normal fault. . . . .	6-2
normal stress. . . . .	11-1
north pole. . . . .	3-1
oblique slip. . . . .	13-2
Oblique-slip fault. . . . .	1-17
outcrop prediction. . . . .	9-1
Outcrop Width. . . . .	8-1
Overtured fold. . . . .	6-3
Overtured Limb. . . . .	4-2
Pace length. . . . .	6-3
paleocurrent. . . . .	4-2
Parallel Fold. . . . .	14-1
parallel folding. . . . .	10-1
passive-slip. . . . .	5-4
perpendicular bisector. . . . .	13-3
Pi ( $\pi$ ) diagram. . . . .	5-4
piercing point. . . . .	13-1
pitch. . . . .	1-2, 1-5
plane table. . . . .	1-6
Plunge. . . . .	1-2, 1-5
Plunge direction. . . . .	1-2
plunging anticlines. . . . .	1-16
plunging anticlines . . . . .	1-16
plunging synclines. . . . .	1-16
pocket transit. . . . .	1-6
Point cluster. . . . .	10-1
Point maximum. . . . .	5-3
pole. . . . .	3-2, 4-1
primary bedding. . . . .	4-2
primitive. . . . .	3-1
Quadrant. . . . .	1-2, 1-3
rake. . . . .	1-2, 1-5
rake angle. . . . .	3-3
Random Distribution. . . . .	5-3
recumbent. . . . .	5-5
Recumbent fold. . . . .	6-3

reverse dip slip.....	1-18
reverse fault.....	6-2
RF.....	12-2
right lateral.....	1-17
Right-hand rule.....	1-4
rigid-body translation.....	13-1
ripple mark.....	6-1
rotation.....	13-1
rotational axis.....	4-10, 13-3
rotational component.....	13-1
rotational fault.....	4-10
Rotational faults.....	13-3
RS.....	12-2
Rule of V.....	9-1
S0.....	6-1
S1.....	6-1
Schmidt.....	5-1
sense of the rotation.....	13-3
separation.....	13-1
shear stress.....	11-1
shear stress ( $\tau$ ).....	11-1
similar.....	14-1
Similar Fold.....	14-1
Small circle girdle.....	5-4
small circles.....	3-1
sole mark.....	4-8
south pole.....	3-1
strain marker.....	12-1
stress ellipsoid.....	11-1
stress tensor.....	11-1
strike.....	1-2
Strike slip component.....	13-2
Strike-slip fault.....	6-2
Strike-slip fault.....	1-17
superposed.....	6-3
symmetry.....	5-5
syncline.....	6-3
synform.....	1-14, 5-5, 6-3

synformal anticline.....	1-14, 6-3
thrust. ....	6-2
total finite strain ellipse. ....	12-2
Trace. ....	1-2
traverse legs. ....	6-4
Traverses. ....	6-4
Trend. ....	1-2
True dip. ....	1-1, 1-3
true magnetic north. ....	1-6
True Thickness.....	8-1
unconformable.....	1-14
Unconformity.....	6-2
United State Geological Survey.....	1-7
upright. ....	5-5
Vertical attitude. ....	9-1
Wulff. ....	5-1
z scores.....	10-9
½ apical angle. ....	10-1